

Table of Contents

Artwork Guidelines.....	143	Memos.....	80-82
Automotive Forms.....	6-19	My Choice Creations SM Forms.....	102
Automotive Floor Mats.....	19	New Products.....	4-5
Banking Supplies.....	95	Note Pads/Sticky Notes.....	116-117
Business Cards.....	104-106	Ordering Information.....	142
Business Stationery.....	103-105	Pest Control Forms.....	22
Calendars.....	116	Pharmacy & Vet Forms.....	36
Cash Receipt Books.....	16, 66	Prescription Pads.....	39
Checks.....	84-92	Presentation Folders.....	97
Collection Forms.....	79	Protection Forms.....	28
Contractor Service Forms.....	42-43	Punch Cards & Note Pads.....	117
Custom Book Covers.....	124	Purchase Orders.....	16, 67-69
Custom Business Forms.....	132	Register Forms.....	55-64
Custom Manifold Books.....	123	Register Machines.....	65
Custom Multiform Book Quick Reference.....	124	Rental/DVD/Video Rental.....	35
Custom Multiform Books.....	124-129	Restaurant/Guest Checks.....	29-33
Deposit Tickets.....	92-94	Sales Books & Forms.....	50-54
Design-A-Form SM	133	Self Inking Stamps.....	122
Document Jackets.....	96	Shipping Labels.....	113
Door Hangers.....	107	Shipping/Receiving Forms.....	70-73
Envelopes.....	98-101	Special Feature Pricing.....	123
Florist Forms.....	26	Statements.....	77-78
Form Holders.....	24	Stock Logos.....	134-136
General Repair Forms.....	45	Tags.....	108-111
Gift Certificates.....	114-115	Teller Helper Envelopes.....	95
Gift & Jewelry.....	27	Thermal Rolls.....	83
Guest Checks/Restaurant.....	29-33	Work Order Forms.....	46-49
Hospitality Forms.....	34	Writing Instruments.....	118-121
Human Resource Forms.....	40-41		
HVAC Service Forms.....	21		
Index.....	137-141		
Invoices.....	74-76		
Janitorial Forms.....	23		
Kitchen/Bath Remodeling Forms.....	44		
Labels.....	112-113		
Landscape Forms.....	24-25		
Laser Statements.....	78		
Magnets.....	106		
Marine Repair Forms.....	20		
Medical Forms.....	37-39		

Return Policy

Returns must be approved within 30 days of the purchase date. The returned product is subject to a 10% restocking fee. All returned products must be in saleable condition. Imprinted or Custom orders are non-returnable.

Unconditional Guarantee

Your satisfaction is guaranteed. We are proud of the work we do. If we don't do it right, we'll make it right. Prices, conditions and specifications are subject to change without notice. Colors of products illustrated are approximations. Printed December 2014 • HC115.

Helpful Icons

Look for these helpful icons throughout the catalog to assist you with features, delivery times and new items now available. Our new products are also featured at-a-glance on pages 4-5.



Ordering made easy

Choose the business product you need. Locate the quantity and number of parts you desire. Add any additional costs for extra imprint lines, booking or padding. Select an ink color and typestyle for your heading imprint and we'll take care of the rest. Please note form sizes are width by height and imprint area is height (number of lines) by width. **Call us today!**

Ink Colors

Select from four ink colors (unless noted otherwise) for your heading imprint at no extra charge. Black ink is standard unless otherwise specified. Colors shown are approximate.



Extra Imprint Lines

Additional lines of type (up to 6 lines) in the body of most imprinted forms are \$18.04(R).

Available typestyles for your company imprint

Please specify typestyle by I.D. code for manual and computer forms and checks. If no typestyle is specified, we will use TB2 - Helvetica Bold for the first line and TB1- Helvetica for remaining lines.

TA1 Bookman	TF1 Kabel Md
TA2 Bookman Bold	TF2 Kabel Md Bold
TA3 Bookman Italic	TG1 Galliard
TA4 Bookman Bold Italic	TG2 Galliard Bold
TB1 Helvetica	<i>TG3 Galliard Italic</i>
TB2 Helvetica Bold	<i>TG4 Galliard Bold Italic</i>
<i>TB3 Helvetica Italic</i>	TH1 Helvetica Narrow
<i>TB4 Helvetica Bold Italic</i>	TH2 Helvetica Narrow Bold
TC1 Cloister Black	TJ1 Benguait
TD1 Zapf Chancery	TJ2 Benguait Bold
<i>TE1 Brush Script</i>	<i>TJ3 Benguait Italic</i>
<i>TE2 Brush Script Bold Italic</i>	<i>TJ4 Benguait Bold Italic</i>

Delivery times

From the time we receive your order and proofs are approved, we ship:

Blank Products	1 Day	Floor Mats	5 Days
Business Stationery	5 Days	Imprinted Products	3 Days
Custom Products	7 Days	Magnets	7 Days
Design-A-Form SM	3 Days	Presentation Folders	10 Days
Document Jackets	5 Days	Ready-To-Go Forms	7 Days
Door Hangers	5 Days	Stock Products	1 Day
Envelopes	5 Days	Writing Instruments	7 Days

Samples of most forms are available upon request.

Artwork Guidelines on page 143.

New Products

Valvoline **Multi-Point Vehicle Inspection**

YOUR COMPANY NAME
Address
CITY, STATE, ZIP CODE
Phone Number
Advertising Line

Customer Name: _____ Work Order: _____ Date: / /
Year: _____ Mileage: _____ Model: _____ LIC # _____
VIN: _____ Unit Number: _____ Technician: _____

TOPSIDE

Components	Condition
Lights	
Wiper Blades	
Belt & Tension	
Battery	
Engine Air Filter	
Cabin Air Filter	
Other	

FLUIDS

Fluids	Condition
Transmission	
Engine Oil	
Coolant	
Power Steering	
Brake Fluid	
Washer Fluid	
Other	

BOTTOMSIDE

Components	Condition
Drain Plug	
Steering and Suspension	
Power Train	
Brakes	
Fuel Filter	
Exhaust	

FLUIDS

Fluids	Condition
Manual Transmission	
Transfer Case	
Rear Differential	
Front Differential	
Grease Fittings	
Service Service	
Other	

COURTESIES

Set Tire Pressure	
Install Shocks	
Other	

NOTES/COMMENTS

Left Front **Right Front**

Tread Wear _____ Tread Depth _____
Tire Pressure _____ Tire Pressure _____
Brake Pads _____ Brake Pads _____
Outer _____ Inner _____
Outer _____ Inner _____

Fuel Meter Ticket

YOUR COMPANY NAME
Address
CITY, STATE, ZIP CODE
Phone Number
Advertising Line

Start of Delivery _____ Gallons _____ End of Delivery _____
Gallons _____

CASH CHARGE DATE _____

TANK TRUCK _____ TIME _____ A. M. / P. M.
Year Mile Number _____ GALLON READING START _____
GALLON READING FINISH _____

Previous Mile Number _____ GALLON READING START _____
GALLONS DELIVERED _____ GALS. PRICE AMOUNT _____
PRODUCT _____ TAX _____ TOTAL _____

No. 001001

Fuel Meter Ticket
Page 15!

WE OWE

YOUR COMPANY NAME
Address
CITY, STATE, ZIP CODE
Phone Number

NAME _____ STOCK # _____ NEW USED

ADDRESS _____ YEAR _____ MAKE _____
CITY _____ STATE _____ ZIP _____ MODEL _____
PHONE _____ VIN _____

SALESPERSON _____ DEL. DATE _____

QTY.	NAME OF ITEM OR SERVICE OWED	UNIT	AMOUNT

I hereby agree to WE OWE with the understanding that it is valid for only 30 days. THEREAFTER THE DATE OF DELIVERY and this must have an advance appointment WITH THE SERVICE DEPARTMENT before the above work can be performed.

(FOR APPOINTMENT CALL SERVICE DEPT.)

CUSTOMER _____ DATE _____ APPROVED _____

We Owe
Page 15!

Multi-Point Vehicle Inspection
Page 14!

Cash Receipt Books

YOUR COMPANY NAME
Address
CITY, STATE, ZIP CODE
Phone Number

RECEIVED OF _____ DATE _____ DOLLARS _____

DETAIL	ACCOUNT	NOTE	HOW PAID	REMARKS

THANK YOU

Cash Receipt Books
Page 16!

Purchase Order Book

YOUR COMPANY NAME
Address
CITY, STATE, ZIP CODE
Phone Number

RECEIVED OF _____ DATE _____ DOLLARS _____

DETAIL	ACCOUNT	NOTE	HOW PAID

THANK YOU

Purchase Order Book

YOUR COMPANY NAME
Address
CITY, STATE, ZIP CODE
Phone Number

RECEIVED OF _____ DATE _____ DOLLARS _____

DETAIL	ACCOUNT	NOTE	HOW PAID

THANK YOU

Purchase Order Book
Page 67!



Thermal Rolls
Page 83!



Florist Cards and Envelopes
Page 26!

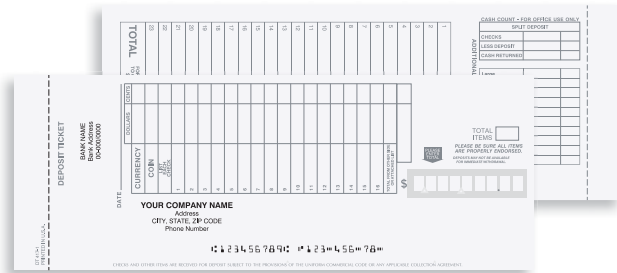

Deposit Ticket Book
Page 92!

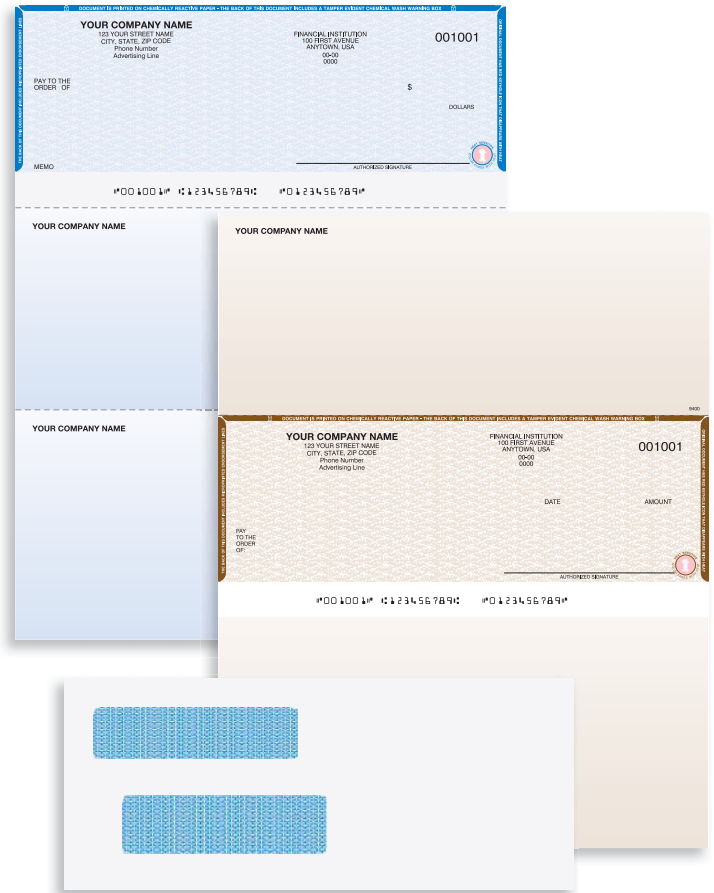

Laser Checks and Corresponding Envelopes
Page 92!

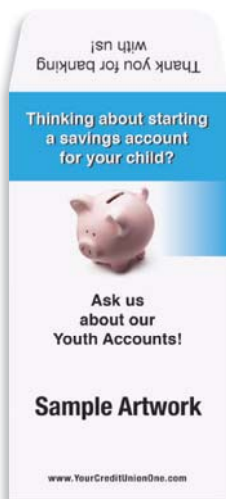

Teller Helper Envelope
Page 95!



Presentation Folders
Page 97!

BEST SELLER

AUTO REPAIR ORDER

OFFICE COPY

DO NOT WRITE IN THESE SPACES
 THESE SPACES ARE RESERVED FOR THE
 PARTS DEPARTMENT TO RECORD PARTS
 QUANTITIES WHICH THE BRANCH CHECK TEST
 PARTS BY THE WORKSHOP.

YOUR COMPANY NAME
 Address
 CITY, STATE, ZIP CODE
 Phone Number
 Advertising Line

Name _____ City _____
 Address _____
 Vln. No. _____
 Year-Make-Model _____ License No. _____
 ESTIMATE AMT. _____
 ADD'L AUTH. AMT. _____
 REVISED ESTIMATE _____
 DATE _____ APPROVED BY _____
 TIME: IN PERSON PHONE _____
 OPER. NO. _____ REPAIR ORDER LABOR INSTRUCTION _____

Additional Material from reserve list: _____ QTY. _____ SALE _____ BILLING _____ INTERNAL ORDER _____
 TOTAL PARTS _____ QTS. GAS _____ CASH _____
 QTS. OIL _____ CHARGE _____
 LBS. GREASE _____ INTERNAL _____
 TOTAL GAS OIL GREASE _____ and by _____
RECOMMENDED SERVICE:

1. _____
 2. _____
 3. _____
 4. _____
 5. _____
 TOTAL SPECIAL REPAIRS _____

001001

BEST SELLER

REPAIR ORDER

ESTIMATED FOR LABOR ONLY - MATERIAL - ADDITIONAL

YOUR COMPANY NAME
 Address
 CITY, STATE, ZIP CODE
 Phone Number
 Advertising Line

Name _____ 001001
 Address _____
 Phone No. _____ Date _____
 Odometer Reading _____ Vin No. _____
 MAKE AND MODEL _____ LICENSE NO. AND STATE _____ MOTOR VEH. _____

QTY.	PART NO.	NAME OF PART	SALE AMT.	OPERATION	INSTRUCTIONS	AMOUNT
				<input type="checkbox"/> LUBE OIL <input type="checkbox"/> CHANGE OIL <input type="checkbox"/> TRANS. <input type="checkbox"/> DIFF. <input type="checkbox"/> WASH <input type="checkbox"/> POLISH		
TOTAL PARTS						
Gals. Gas @						Total Labor
Qts. Oil @						Total Parts
Lbs. Grease @						Environmental Charge
						Gas, Oil, Grease
						Accessories
						Tires, Tubes
						Sublet Repairs
						Shop/Misc.
						TOTAL
						TAX
						TOTAL AMOUNT

Work Authorized by _____ Date Promised _____
 Delivered to _____ Date Delivered _____

AROC-600'S PRINTED IN U.S.A.

C AROCC-665, 365, ARO-672, 372 - Snap-A-Part
 Auto Repair Order, 11" x 8½"
 Imprint area 1" x 4"

D AROCC-600, ARO-666 - Snap-A-Part
 Auto Repair Order, 8½" x 7"
 Imprint area 1" x 3"

C AROCC-665, 365, ARO-672, 372 - Auto Repair Order

Cat. No.	Pts.	Wt. per 1000	Carbonless Lot Prices				
AROCC-			250	500	1000	2000	3000
665-4	4	43#	150.33	241.02	430.30	811.15	1,190.23
365-4*	4	43#	150.33	241.02	430.30	811.15	1,190.23
ARO-			Carbon Lot Prices				
672-4	4	51#	124.44	199.73	356.36	668.88	980.67
372-4*	4	51#	124.44	199.73	356.36	668.88	980.67

*Valid in California, not shown. (R)
 Last part is manila tag.

D AROCC-600, ARO-666 - Auto Repair Order

Cat. No.	Pts.	Wt. per 1000	Carbonless Lot Prices				
AROCC-			250	500	1000	2000	3000
600-3	3	24#	103.12	156.05	269.72	493.43	719.73
ARO-			Carbon Lot Prices				
666-3	3	27#	100.52	151.58	260.57	476.37	693.63

Last part is manila tag. (R)

E ROCC-573, RO-673 - Auto Repair Order

Cat. No.	Pts.	Wt. per 1000	Carbonless Lot Prices				
ROCC-			250	500	1000	2000	3000
573-3	3	21#	83.98	121.32	200.55	357.50	518.28
RO-			Carbon Lot Prices				
673-3	3	22#	81.17	113.00	181.64	318.29	458.28

Last part is manila tag. No back printing. (R)

REPAIR ORDER

YOUR COMPANY NAME
 Address
 CITY, STATE, ZIP CODE
 Phone Number
 Advertising Line

001001

Name _____
 Address _____
 Phone No. _____
 Date _____
 Odometer Reading _____
 MAKE AND MODEL _____

QTY.	PART NO.	NAME OF PART	SALE AMT.	OPERATION	INSTRUCTIONS	AMOUNT
				<input type="checkbox"/> LUBE OIL <input type="checkbox"/> CHANGE OIL <input type="checkbox"/> TRANS. <input type="checkbox"/> DIFF. <input type="checkbox"/> WASH <input type="checkbox"/> POLISH		
TOTAL PARTS						
						Total Labor
						Total Parts
						Environmental Charge
						Gas, Oil, Grease
						Accessories
						Tires, Tubes
						Sublet Repairs
						Shop/Misc.
						TOTAL
						TAX
						TOTAL AMOUNT

Work Authorized by _____ Date Promised _____
 Delivered to _____ Date Delivered _____

AROC-600'S PRINTED IN U.S.A.

E ROCC-573, RO-673 - Snap-A-Part
 Auto Repair Order, 8½" x 5½"
 Imprint area 1" x 3"

NOTE:



D AROCC-644, ARO-637 - Snap-A-Part
 Auto Repair Order, 11" x 8½"
 Imprint area 1" x 4"
 Designed for use in Florida. (revised 2/08)

E AROCC-624, ARO-659 - Snap-A-Part
 Auto Repair Order, 11" x 8½"
 Imprint area 1" x 4"

D AROCC-644, ARO-637 - Auto Repair Order

Cat. No.	Pts.	Wt. per 1000	Carbonless Lot Prices			
			250	500	1000	3000
AROCC-						
644-3	3	35#	118.20	191.93	340.55	652.86
644-4	4	43#	150.33	241.02	430.30	811.15
ARO-						
			Carbon Lot Prices			
637-3	3	41#	110.08	170.40	297.18	549.28
637-4	4	51#	124.44	199.73	356.36	668.88

Last part is manila tag. (R)

E AROCC-624, ARO-659 - Auto Repair Order

Cat. No.	Pts.	Wt. per 1000	Carbonless Lot Prices			
			250	500	1000	3000
AROCC-						
624-3	3	35#	118.20	191.93	340.55	652.86
624-4	4	43#	150.33	241.02	430.30	811.15
ARO-						
			Carbon Lot Prices			
659-3	3	41#	110.08	170.40	297.18	549.28
659-4	4	51#	124.44	199.73	356.36	668.88

Last part is manila tag. (R)

F AROCC-685, ARO-682 - Auto Repair Order

Cat. No.	Pts.	Wt. per 1000	Carbonless Lot Prices			
			250	500	1000	3000
AROCC-						
685-3	3	35#	136.92	211.28	359.68	672.10
685-4	4	43#	169.88	260.36	449.85	830.28
ARO-						
			Carbon Lot Prices			
682-3	3	41#	128.70	189.96	316.32	568.72
682-4	4	51#	143.99	218.97	375.91	687.91

Last part is manila tag. (R)

F AROCC-685, ARO-682 - Snap-A-Part
 Auto Repair Order, 11" x 8½"
 Imprint area 1" x 4"
 Message area 2¾" x 4"

NOTE:

1
Day
Blank

3
Day
Imprint

Shipping

001001

YOUR COMPANY NAME
Address
CITY, STATE, ZIP CODE
Phone Number
Advertising Line

Name _____ Date _____ AM, PM
Order Written By _____

Address _____ City _____ Phone _____

Year and Make _____ Model _____ Motor No. _____ Plate _____

Color _____ License _____ Postpaid _____ State _____

Condition _____ INSTRUCTIONS _____ AMOUNT _____

WORK AUTHORIZED BY _____ DATE _____

DELIVERED TO _____ DATE DELIVERED _____

TOTAL AMOUNT

001001

YOUR COMPANY NAME
Address
CITY, STATE, ZIP CODE
Phone Number
Advertising Line

DATE _____ LABOR CHARGE _____

WORK AUTHORIZED BY _____ DATE _____

DELIVERED TO _____ DATE DELIVERED _____

TOTAL AMOUNT

**A AROCC-677, 377
ARO-671, 371
Snap-A-Part**
Auto Repair Order, 8½" x 8½"
Imprint area 1" x 4"

B AROCC-648 - Snap-A-Part
Auto Repair Estimate, 11" x 8½"
Imprint area 1" x 3¼"

001001

YOUR COMPANY NAME
Address
CITY, STATE, ZIP CODE
Phone Number
Advertising Line

Name _____ Date _____ AM, PM
Order Written By _____

Address _____ City _____ Phone _____

Year and Make _____ Model _____ Motor No. _____ Plate _____

Color _____ License _____ Postpaid _____ State _____

Condition _____ INSTRUCTIONS _____ AMOUNT _____

WORK AUTHORIZED BY _____ DATE _____

DELIVERED TO _____ DATE DELIVERED _____

TOTAL AMOUNT

A AROCC-677, 377, ARO-671, 371 - Auto Repair Order

Cat. No.	Pts.	Wt. per 1000	Carbonless Lot Prices				
			250	500	1000	2000	3000
677-4	4	35#	161.88	260.68	416.47	751.66	1,096.73
377-4*	4	35#	161.88	260.68	416.47	751.66	1,096.73

Cat. No.	Pts.	Wt. per 1000	Carbon Lot Prices				
			250	500	1000	2000	3000
671-4	4	40#	118.30	186.84	326.82	614.48	903.08
371-4*	4	40#	118.30	186.84	326.82	614.48	903.08

*Valid in California, not shown. Last part is manila tag. (R)

B AROCC-648 - Auto Repair Estimate

Cat. No.	Pts.	Wt. per 1000	Carbonless Lot Prices				
			250	500	1000	2000	3000
648-4	4	46#	150.33	241.02	430.30	811.15	1,190.23

Valid in California. Last part is manila tag. (R)

C AROCC-374, ARO-373 - Auto Repair Order

Cat. No.	Pts.	Wt. per 1000	Carbonless Lot Prices				
			250	500	1000	2000	3000
374-4	4	43#	150.33	241.02	430.30	811.15	1,190.23

Cat. No.	Pts.	Wt. per 1000	Carbon Lot Prices				
			250	500	1000	2000	3000
373-4	4	51#	124.44	199.73	356.36	668.88	980.67

Valid in California. Last part is manila tag. (R)

C AROCC-374, ARO-373 - Snap-A-Part
Auto Repair Order, 11" x 8½"
Imprint area 1" x 3¼"

NOTE:



Company Imprint

Includes your company's name, address and phone number in one of four colors! For blank forms, subtract 30%.



Starting Number

Choose a six-digit starting number for your imprinted form at no extra charge! Otherwise, we will start with 001001. Four, five and seven-digit numbering available at an additional charge. See page 142 for pricing.



Multi-part Color Sequence

Colors correspond to sequence and number of parts selected in your order unless otherwise specified.

Blank forms will be sequentially numbered unless specified otherwise.

Estimate and Repair Order form for EROCC-560, ERO-660. Includes company information, vehicle details, and a large grid for labor and parts.

Repair Estimate form for RECC-621, RE-661. Includes company information, vehicle details, and a large grid for labor and parts.

D EROCC-560, ERO-660 - Snap-A-Part Estimate and Repair Order, 8 1/2" x 11" Imprint area 1" x 4"

E RECC-621, RE-661 - Snap-A-Part Repair Estimate, 8 1/2" x 11" Imprint area 1" x 4"

Table with Carbonless Lot Prices for EROCC-560, ERO-660. Columns include Cat No., Pts., Wt. per 1000, and prices for quantities 250, 500, 1000, 2000, and 3000.

Estimate form for ES-697. Includes company information, vehicle details, and a large grid for labor and parts.

Table with Carbonless Lot Prices for RECC-621, RE-661. Columns include Cat No., Pts., Wt. per 1000, and prices for quantities 250, 500, 1000, 2000, and 3000.

Table with Carbonless Lot Prices for ES-697. Columns include Cat No., Pts., Wt. per 1000, and prices for quantities 250, 500, 1000, 2000, and 3000.



F ES-697 - Snap-A-Part Estimate, 8 1/2" x 11" Imprint area 1" x 4"

SOCC 505-A PRINTED IN U.S.A.			SERVICE ORDER		
JOB NAME _____					
QTY.	DESCRIPTION	PR/PC	YOUR COMPANY NAME Address CITY, STATE, ZIP CODE Phone Number Advertising Line DATE _____ NAME _____ ADDRESS _____ CITY _____ STATE _____ ZIP CODE _____ PHONE _____ <input type="checkbox"/> ESTIMATE <input type="checkbox"/> WARRANTY <input type="checkbox"/> CONTRACT DATE OF PERM. INSTALLATION _____ DATE COMPLETED _____ SERVICE CALL CHARGE _____ TAX _____ CASH <input type="checkbox"/> CREDIT <input type="checkbox"/> CHECK		
TOTAL MATERIALS			TOTAL 001001		
INVOICE 001001 THANK YOU			DATE _____ 001001		
CLAIM CHECK			YOUR COMPANY NAME _____ Address _____ CITY, STATE, ZIP CODE _____ Phone Number _____ Advertising Line _____		

No merchandise delivered without this check. Not responsible for goods left over 30 days nor for loss by fire or theft.

A SOCC-505 - Snap-A-Part
Service Order, 8½" x 8½"
Imprint area: Top - 1" x 4", Bottom - 1" x 3"

Dear Customer, Date _____

The merchandise we ordered for you has arrived.

Please pick it up as soon as possible.
 We will deliver

Thank you for your patronage!

SOCC 695
PRINTED IN U.S.A.

SPECIAL ORDER

YOUR COMPANY NAME
P.O. Box
Address
CITY, STATE, ZIP CODE
Phone Number

DATE _____ 001001

QUANTITY	DESCRIPTION	AMOUNT

SPECIAL INSTRUCTIONS _____

TAX _____
TOTAL DEPOSIT _____
BALANCE DUE _____

CUSTOMER NAME (Please print) _____
CUSTOMER SIGNATURE _____
PHONE _____

CUSTOMER COPY

ORDERED FROM _____ DATE ORDERED _____ INV. NO. _____
 ADDRESS _____ DATE RECEIVED _____ ORDER NO. _____
 PHONE _____ RECEIVED _____ PICKED UP _____

B SOCC-695 - Snap-A-Part
Special Order Form, 5½" x 7¾"
Imprint area 1¼" x 3"

REPAIR ORDER/INVOICE		YOUR COMPANY NAME	
PART NO. & DESCRIPTION <small>All parts new unless otherwise specified.</small>		Address CITY, STATE, ZIP CODE Phone Number Advertising Line DATE _____ 001001	
QTY.	DESCRIPTION	AMOUNT	
TOTAL			
WARRANTEE STATEMENT		I hereby warrant the above repair work to be done along with necessary materials. You and your employees may accept jobs orders by telephone or radio, subject to the following: An express acknowledgment slip is understood that this company assumes no responsibility for loss or damage to parts or tires in vehicle placed with them for storage, sale, repair or while road testing, etc. <input type="checkbox"/> I REQUEST A WRITTEN ESTIMATE. <input type="checkbox"/> I DO NOT REQUEST A WRITTEN ESTIMATE AS LONG AS THE REPAIR COST DOES NOT EXCEED \$_____. SHOP MAY NOT EXCEED THIS AMOUNT WITHOUT MY APPROVAL. <input type="checkbox"/> I DO NOT REQUEST A WRITTEN ESTIMATE.	
Any warranties on the products sold hereby are those made by the manufacturer. The seller (above named Dealership) hereby expressly disclaims all warranties, either express or implied, including any implied warranty of merchantability or fitness for a particular purpose, and neither assumes nor addresses any other periods to assume for a liability in connection with the sale of said products.		ESTIMATE CHARGE	
PLEASE READ CAREFULLY CHECK ONE OF THE STATEMENTS BELOW AND SIGN UNDERSTAND THAT UNDER STATE LAW I AM ENTITLED TO A WRITTEN ESTIMATE IF MY DEALER WILL EXCEED \$_____.		TOTAL PARTS	
I request a written estimate.		TOTAL LABOR	
I do not request a written estimate as long as the repair cost does not exceed \$_____. Shop may not exceed this amount without my approval.		TOTAL REFINISH	
I do not request a written estimate.		TOTAL SUBLET	
Reduced parts will be returned if you request them when the repairs are ordered. (You may inspect those parts which must be returned to the manufacturer.)		TOWING	
Requested Parts Replacement by Customer (Please Check) <input type="checkbox"/> Yes <input type="checkbox"/> No		EPA/WASTE DISPOSAL	
If heavy vehicles the above repair work to be done along with necessary materials. You and your employees may accept jobs orders by telephone or radio, subject to the following: An express acknowledgment slip is understood that this company assumes no responsibility for loss or damage to parts or tires in vehicle placed with them for storage, sale, repair or while road testing, etc.		STORAGE	
DEBITABLE FUND BY <input type="checkbox"/> Cash <input type="checkbox"/> Check <input type="checkbox"/> Credit Card <input type="checkbox"/> MC <input type="checkbox"/> AMEX <input type="checkbox"/> VISA		SUB-TOTAL	
Other _____ CC No. _____		TAX	
Signature _____ Date _____ NAME _____ ADDRESS _____ CITY _____ STATE _____ ZIP CODE _____ PHONE _____		LESS DEPOSIT	
TOTAL		TOTAL	

C ROI-694 - Snap-A-Part
Repair Order/Invoice, 8½" x 11"
Imprint area 1" x 4"

A SOCC-505 - Service Order

Cat. No.	Pts.	Wt. per 1000	Carbonless Lot Prices					
			250	500	1000	2000	3000	
SOCC-								
505-2	2	17#	126.62	203.68	312.68	518.28	767.88	
505-3	3	24#	150.64	243.93	381.94	670.96	993.88	
505-4	4	31#	161.88	260.68	416.47	751.66	1,096.73	

Last part is manila tag. (R)

B SOCC-695 - Special Order Form

Cat. No.	Pts.	Wt. per 1000	Carbonless Lot Prices					
			250	500	1000	2000	3000	
SOCC-								
695-3	3	17#	83.98	121.32	200.56	357.50	518.28	

Last part is white tag. (R)

C ROI-694 - Repair Order/Invoice

Cat. No.	Pts.	Wt. per 1000	Carbonless Lot Prices					
			250	500	1000	2000	3000	
ROI-								
694-4	4	32#	150.33	241.02	430.30	811.15	1,190.23	

Last part is manila tag. (R)

NOTE:

Company Imprint

Includes your company's name, address and phone number in one of four colors! For blank forms, subtract 30%.

Starting Number

Choose a six-digit starting number for your imprinted form at no extra charge! Otherwise, we will start with 001001. Four, five and seven-digit numbering available at an additional charge. See page 142 for pricing.

Multi-part Color Sequence

Colors correspond to sequence and number of parts selected in your order unless otherwise specified.

Blank forms will be sequentially numbered unless specified otherwise.

SMOCC-640, SWO-643 - Snap-A-Part

SMOG CHECK WORK ORDER

YOUR COMPANY NAME
Address
CITY, STATE, ZIP CODE
Phone Number
Advertising Line

NAME: 001001
ADDRESS
CITY, STATE, ZIP CODE
PHONE NUMBER
DATE OF ORDER

CUSTOMER'S ORDER NO. VIN NO.
YEAR MAKE AND MODEL
LICENSE NUMBER
MILEAGE
METER

ORDER WRITTEN BY
LABOR INSTRUCTIONS
AMOUNT

GROSS VEHICLE WEIGHT
IM SMOG INSPECTION
CERTIFICATE #

DATE PROMISED

EMISION CHECK OFF

PCV TWC
TAC EGR
AIR SPK
EVP CCO
PI INJ
CO

SMOG TEST / EMISSION CHECK OFF

PCV
TAC
CAT
EVP
FR
OC
AIR
TWC
AP/PI

SMOG TEST
PRETEST
CERTIFICATE #
ELECTRONIC TRANSFER FEE (E.T.F.)
RETEST
GAS CAP

SMOG TEST ONLY STATION CANNOT PERFORM ANY DIAGNOSTICS, ADJUSTMENTS OR REPAIRS

THIS STATION CANNOT PERFORM ANY DIAGNOSTICS, ADJUSTMENTS OR REPAIRS

STOICC-341 - Snap-A-Part
Smog Test Only Invoice, 8 1/2" x 7"
Imprint area 1" x 5"

D SWOCC-640, SWO-643 - Snap-A-Part
Smog Check Work Order, 8 1/2" x 8 1/2"
Imprint area 1" x 3"

D SWOCC-640, SWO-643 - Smog Check Work Order

Cat. No.	Wt.	Carbonless Lot Prices					
SWOCC-	Pts.	per 1000	250	500	1000	2000	3000
640-4	4	31#	161.88	260.68	416.47	751.66	1,096.73
SWO-	Pts.	per 1000	250	500	1000	2000	3000
643-4	4	32#	118.30	186.84	326.82	614.48	903.08

Valid in California. (R)
Last part is manila tag.

E STOICC-341 - Smog Test Only Invoice

Cat. No.	Wt.	Carbonless Lot Prices					
STOICC-	Pts.	per 1000	250	500	1000	2000	3000
341-3	3	16#	99.06	148.56	252.36	460.88	669.19

Valid in California. (R)

F SCCACC-385, SCCA-375 - Smog Control Order

Cat. No.	Wt.	Carbonless Lot Prices					
SCCACC-	Pts.	per 1000	250	500	1000	2000	3000
385-4	4	43#	150.33	241.02	430.30	811.15	1,190.23
SCCA-	Pts.	per 1000	250	500	1000	2000	3000
375-4	4	51#	124.44	199.73	356.36	668.88	980.67

Valid in California. (R)
Last part is manila tag.

NOTE:

1 Day Blank
3 Day Imprint
Shipping

STOICC-341 - Snap-A-Part

SMOG TEST ONLY INVOICE

YOUR COMPANY NAME
Address
CITY, STATE, ZIP CODE
Phone Number
Advertising Line

NAME: 001001
ADDRESS
CITY, STATE, ZIP CODE
PHONE NUMBER
DATE OF ORDER

CUSTOMER'S ORDER NO. VIN NO.
YEAR MAKE AND MODEL
LICENSE NUMBER
MILEAGE
METER

ORDER WRITTEN BY
LABOR INSTRUCTIONS
AMOUNT

GROSS VEHICLE WEIGHT
IM SMOG INSPECTION
CERTIFICATE #

DATE PROMISED

EMISION CHECK OFF

PCV TWC
TAC EGR
AIR SPK
EVP CCO
PI INJ
CO

SMOG TEST / EMISSION CHECK OFF

PCV
TAC
CAT
EVP
FR
OC
AIR
TWC
AP/PI

SMOG TEST
PRETEST
CERTIFICATE #
ELECTRONIC TRANSFER FEE (E.T.F.)
RETEST
GAS CAP

SMOG TEST ONLY STATION CANNOT PERFORM ANY DIAGNOSTICS, ADJUSTMENTS OR REPAIRS

THIS STATION CANNOT PERFORM ANY DIAGNOSTICS, ADJUSTMENTS OR REPAIRS

STOICC-341 - Snap-A-Part
Smog Test Only Invoice, 8 1/2" x 7"
Imprint area 1" x 5"

E STOICC-341 - Snap-A-Part
Smog Test Only Invoice, 8 1/2" x 7"
Imprint area 1" x 5"

SCCACC-385, SCCA-375 - Snap-A-Part

SMOG CONTROL ORDER

YOUR COMPANY NAME
Address
CITY, STATE, ZIP CODE
Phone Number
Advertising Line

NAME: 001001
ADDRESS
CITY, STATE, ZIP CODE
PHONE NUMBER
DATE OF ORDER

CUSTOMER'S ORDER NO. VIN NO.
YEAR MAKE AND MODEL
LICENSE NUMBER
MILEAGE
METER

ORDER WRITTEN BY
LABOR INSTRUCTIONS
AMOUNT

GROSS VEHICLE WEIGHT
IM SMOG INSPECTION
CERTIFICATE #

DATE PROMISED

EMISION CHECK OFF

PCV TWC
TAC EGR
AIR SPK
EVP CCO
PI INJ
CO

SMOG TEST / EMISSION CHECK OFF

PCV
TAC
CAT
EVP
FR
OC
AIR
TWC
AP/PI

SMOG TEST
PRETEST
CERTIFICATE #
ELECTRONIC TRANSFER FEE (E.T.F.)
RETEST
GAS CAP

SMOG TEST ONLY STATION CANNOT PERFORM ANY DIAGNOSTICS, ADJUSTMENTS OR REPAIRS

THIS STATION CANNOT PERFORM ANY DIAGNOSTICS, ADJUSTMENTS OR REPAIRS

SCCACC-385, SCCA-375 - Snap-A-Part
Smog Control Order, 8 1/2" x 11"
Imprint area 1" x 4"

F SCCACC-385, SCCA-375 - Snap-A-Part
Smog Control Order, 8 1/2" x 11"
Imprint area 1" x 4"

Valvoline **Mobil**

Multi-Point Vehicle Inspection

YOUR COMPANY NAME
Address
CITY, STATE, ZIP CODE
Phone Number
Advertising Line

Work Order: _____ Mileage: _____ Date: ____/____/____

Make: _____ Model: _____ LIC # _____

Unit Number: _____ Technician: _____

NEW ITEM

AND OKAY AT THIS TIME **MAY REQUIRE FUTURE ATTENTION** **REQUIRES IMMEDIATE ATTENTION**

Oil Level	Oil Level On Arrival	Full	Low
Components	TOPSIDE	Condition	
Lights			
Wiper Blades			
Belts & Hoses			
Battery			
Engine Air Filter			
Cabin Air Filter			
Other			
Fluids		Condition	
Transmission			
Engine Oil			
Coolant			
Power Steering			
Brake Fluid			
Washer Fluid			
Other			
Components	BOTTOMSIDE	Condition	
Drain Plugs			
Steering and Suspension			
Power Train			
Brakes			
Fuel Filter			
Exhaust			
Fluids		Condition	
Manual Transmission			
Transfer Case			
Rear Differential			
Front Differential			
Grease Fittings			
30/60/90 Service			
Other			
COURTESIES			
Set Tire Pressure			
Install Socker			
Other			

NOTES/COMMENTS

Left Front
Tread Wear: _____
Tread Depth: _____
Tire Pressure: _____
Brake Pads: _____
Outer: _____ Inner: _____

Right Front
Tread Wear: _____
Tread Depth: _____
Tire Pressure: _____
Brake Pads: _____
Outer: _____ Inner: _____

Left Rear
Tread Wear: _____
Tread Depth: _____
Tire Pressure: _____
Brake Pads: _____
Outer: _____ Inner: _____

Right Rear
Tread Wear: _____
Tread Depth: _____
Tire Pressure: _____
Brake Pads: _____
Outer: _____ Inner: _____

A MPVCC-690 - Snap-A-Part
Multi-Point Vehicle Inspection, 8 1/2" x 11"
Imprint area 1" x 8"
Imprint just your company information or add the brand logos of your choice.

EMISSION CONTROL WORK ORDER

YOUR COMPANY NAME
Address
CITY, STATE, ZIP CODE
Phone Number
Advertising Line

001001

DATE: _____
TIME: _____
MILEAGE: _____
VIN: _____
LIC: _____

EMISION CONTROL WORK ORDER

Code

New Lamp Yes

Oil Filled Yes

Check Yes

Other

EMISION CONTROL WORK ORDER

ALL PARTS ARE NEW UNLESS OTHERWISE DESIGNATED

QTY	CODE	NAME	UNIT	AMOUNT	REPAIR ORDER LABOR	REPAIR ORDER MATERIAL	INTERNAL
TOTAL PARTS							

THIS IS TO ADVISE YOU THAT SOME EMISSION CONTROL DEVICES MAY STILL BE COVERED UNDER MFL'S WARRANTY. YOU MAY CHOOSE ANOTHER LICENSED SMOG CHECK FACILITY TO PERFORM ANY NEEDED REPAIRS OR ADJUSTMENTS THAT THE SMOG CHECK TEST INDICATES ARE NECESSARY.

ESTIMATE: INSPECTION FEE: _____ RETURN OLD PARTS: YES NO

TOTAL ESTIMATE: _____

DATE: _____ TIME: _____

B ECO-674 - Snap-A-Part
Emission Control Work Order, 8 1/2" x 8 1/2"
Imprint area 1" x 4"

A MPVCC-690 - Multi-Point Vehicle Inspection

Cat. No.	Pts.	Wt. per 1000	Carbonless Lot Prices					
			250	500	1000	2000	5000	
MPVCC-690-2	2	20#	174.95	233.25	374.85	633.10	749.70	1,416.10
690-3	3	22#	199.90	308.20	533.10	916.30	1,132.90	2,165.80
690-4	4	27#	249.90	374.85	683.05	1,249.50	1,499.40	2,932.16

B ECO-674 - Emission Control Work Order

Cat. No.	Pts.	Wt. per 1000	Carbon Lot Prices			
			250	500	1000	2000
ECO-674-3	3	32#	91.36	132.65	221.68	398.48
674-4	4	40#	101.97	154.60	266.29	487.19

C TROCC-633, TRO-638 - Transmission Repair Order

Cat. No.	Pts.	Wt. per 1000	Carbonless Lot Prices			
			250	500	1000	2000
TROCC-633-4	4	43#	150.33	241.02	430.30	811.15
TRO-638-4	4	51#	124.44	199.73	356.36	668.88

Last part is manila tag.

NOTE:

Company Imprint

Includes your company's name, address and phone number in one of four colors! For blank forms, subtract 30%.

Multi-part Color Sequence

Colors correspond to sequence and number of parts selected in your order unless otherwise specified.

Starting Number

Choose a six-digit starting number for your imprinted form at no extra charge! Otherwise, we will start with 001001. Four, five and seven-digit numbering available at an additional charge. See page 142 for pricing.

Blank forms will be sequentially numbered unless specified otherwise.

TROCC-633, TRO-638

YOUR COMPANY NAME
Address
CITY, STATE, ZIP CODE
Phone Number
Advertising Line

001001

DATE: _____ TIME: _____

MAKE: _____ MODEL: _____ YEAR: _____

PHONE WHEN READY: _____ EXTENSION: _____

ESTIMATE: _____

REPAIRED AMOUNT: _____

QTY	CODE	NAME	UNIT	AMOUNT	REPAIR ORDER LABOR	REPAIR ORDER MATERIAL	INTERNAL
TOTAL PARTS							

HAZARDOUS WASTE

TOTAL LABOR: _____

TOTAL PARTS: _____

SUBLET REPAIRS: _____

TOTAL BEFORE TAX: _____

TOTAL AMOUNT: _____

C TROCC-633, TRO-638 - Snap-A-Part
Transmission Repair Order, 11" x 8 1/4"
Imprint area 1" x 3 1/4"

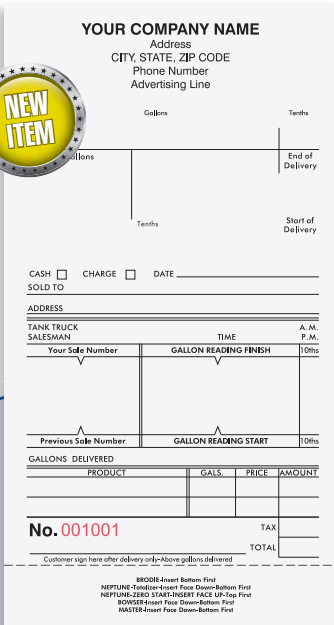

A FMTCC-898, FMT-897 - Snap-A-Part
Fuel Meter Ticket, 4 1/8" x 7 3/4"
Imprint area 1" x 3 1/2"

YOUR COMPANY NAME
Address
CITY, STATE, ZIP CODE
Phone Number
Advertising Line

NEW ITEM

Gallons _____ Tenths _____
End of Delivery _____
Start of Delivery _____

CASH CHARGE DATE _____

SOLD TO _____
ADDRESS _____

TANK TRUCK SALESMAN _____ TIME _____ A. M. P. M.

Your Side Number _____ GALLON READING FINISH _____ 10ths _____

Previous Side Number _____ GALLON READING START _____ 10ths _____

GALLONS DELIVERED	PRODUCT	GALS.	PRICE	AMOUNT

No. **001001** TAX _____ TOTAL _____

Customer sign here after delivery on—Above gallons delivered

8909H—Insert Bottom First
NEPTUNE—Transfer Insert Face Down—Bottom First
NEPTUNE—2202—START/END FUEL UP—Top First
BOWSER—Insert Face Down—Bottom First
WASTER—Insert Face Down—Bottom First



B SA-1506 - Snap-A-Part
We Owe, 8 1/2" x 5 5/8"
Imprint area 3/4" x 4 3/8"

YOUR COMPANY NAME
Address
CITY, STATE, ZIP CODE
Telephone Number

WE OWE

NAME _____ STOCK # _____ NEW USED _____

ADDRESS _____ YEAR _____ MAKE _____

CITY _____ STATE _____ ZIP _____ MODEL _____

PHONE _____ VIN _____

SALESPERSON _____ DEL. DATE _____

CITY	NAME OF ITEM OR SERVICE OWED	PART	LABOR

I hereby accept this WE OWE with the understanding that it is valid for only (30) THIRTY DAYS FROM DATE OF ISSUANCE, and that I must make an ADVANCE APPOINTMENT WITH THE SERVICE DEPARTMENT before the above work can be performed.

(FOR APPOINTMENT CALL SERVICE DEPT.)

DATE _____ APPROVED _____
CUSTOMER _____ SIGN _____

NEW ITEM

DEAL JACKET

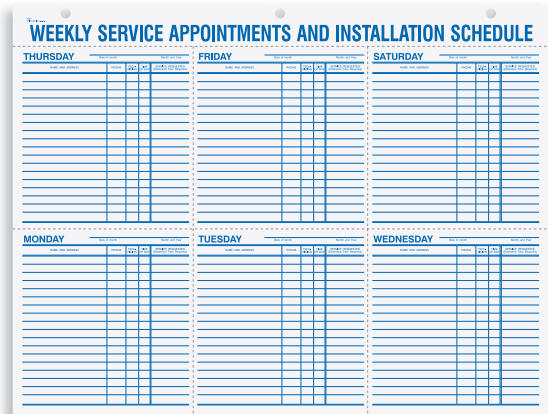

C 9927 - Weekly Service Appointment Pad
Weekly Service Appointment Pad, 22" x 17"
52 pages per pad

WEEKLY SERVICE APPOINTMENTS AND INSTALLATION SCHEDULE

THURSDAY				FRIDAY				SATURDAY			
TIME	NAME	ADDRESS	PHONE	TIME	NAME	ADDRESS	PHONE	TIME	NAME	ADDRESS	PHONE

MONDAY				TUESDAY				WEDNESDAY			
TIME	NAME	ADDRESS	PHONE	TIME	NAME	ADDRESS	PHONE	TIME	NAME	ADDRESS	PHONE

A FMTCC-898, FMT-897 - Fuel Meter Ticket

Cat. No.	Pts.	Wt. per 1000	250	500	Carbonless Lot Prices			
FMTCC-898-3	3	12#	79.63	109.45	1000	2000	3000	5000
					175.00	305.70	429.75	668.25

Cat. No.	Pts.	Wt. per 1000	250	500	Carbon Lot Prices			
FMT-897-3	3	16#	72.50	100.10	1000	2000	3000	5000
					156.70	269.60	381.00	596.00

Part one not self-contained. Call for pricing if required. (R)
Last part is manila tag.

B SA-1506 - We Owe

Cat. No.	Pts.	Wt. per 1000	250	500	Carbonless Lot Prices			
SA-1506-3	3	21#	58.01	80.57	1000	2000	5000	10000
					115.10	205.47	475.48	922.41
SA-1506-4	4	27#	86.18	114.90	1000	2000	5000	10000
					164.13	311.83	740.57	1,407.14

Last part is white tag. (R)

C 9927 - Weekly Service Appointment Pad

Cat. No.	Wt. per Pad	1 Pads	2 Pads	3 Pads	4 Pads	5 Pads
9927	3#	39.57	54.44	65.99	79.20	92.30

Not available imprinted or numbered. (R)

D OARE-9920 - Overnight Auto Repair Envelope

Cat. No.	Wt. per 1000	250	500	1000	2000	4000
OARE-9920	24#	114.56	152.83	212.11	361.35	648.80

Custom envelopes available on page 98. (9831) (R)

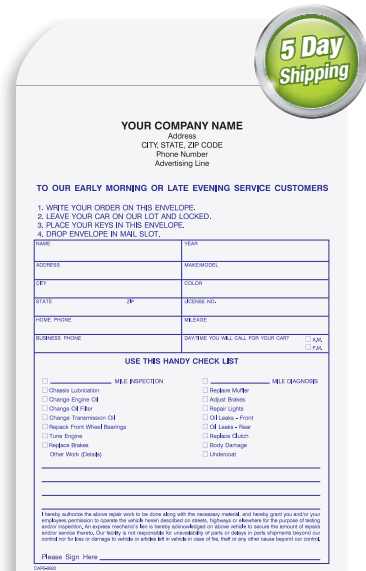

D OARE-9920
Overnight Auto Repair Envelope, 6" x 9"
Imprint area 1 1/4" x 5/4"

YOUR COMPANY NAME
Address
CITY, STATE, ZIP CODE
Phone Number
Advertising Line

5 Day Shipping

TO OUR EARLY MORNING OR LATE EVENING SERVICE CUSTOMERS

1. WRITE YOUR ORDER ON THIS ENVELOPE.
2. LEAVE YOUR CAR ON OUR LOT AND LOCKED.
3. PLACE YOUR KEYS IN THIS ENVELOPE.
4. DROP ENVELOPE IN MAIL SLOT.

NAME	TEAM
ADDRESS	WARRANTY/COLE
KEY	COLOR
STATE	ISSUE NO.
HOME PHONE	RELEASE
BUSINESS PHONE	WHEN WILL YOU CALL FOR YOUR CAR? <input type="checkbox"/> A.M. <input type="checkbox"/> P.M.

USE THIS HANDY CHECK LIST

OIL _____ BELT INSPECTION _____ WAX _____

Check Lubrication New Oil Filter New Oil Pan

Change Engine Oil Adjust Brakes Check Lights

Change Oil Filter Repair Tires Oil Leaks - Front

Change Transmission Oil Oil Leaks - Rear

Replace Front Wheel Bearings Oil Leaks - Rear

Tune Engine Inspect Belts

Inspect Brakes Body Damage

Other (See Details) Unchecked _____

I hereby authorize the above repair work to be done along with the necessary material, and hereby grant you, and your employees, permission to operate the vehicle being repaired or removed to be driven for the purpose of making safety inspection. An engine mechanic is to be made available on duty while the amount of repair work is being performed. We hereby accept responsibility for, and release in writing, all persons beyond our control from any loss or damage to vehicle or articles in vehicle in case of fire, theft or any other cause beyond our control.

Please Sign Here _____

NOTE:

1 Day Blank Shipping
3 Day Imprint Shipping

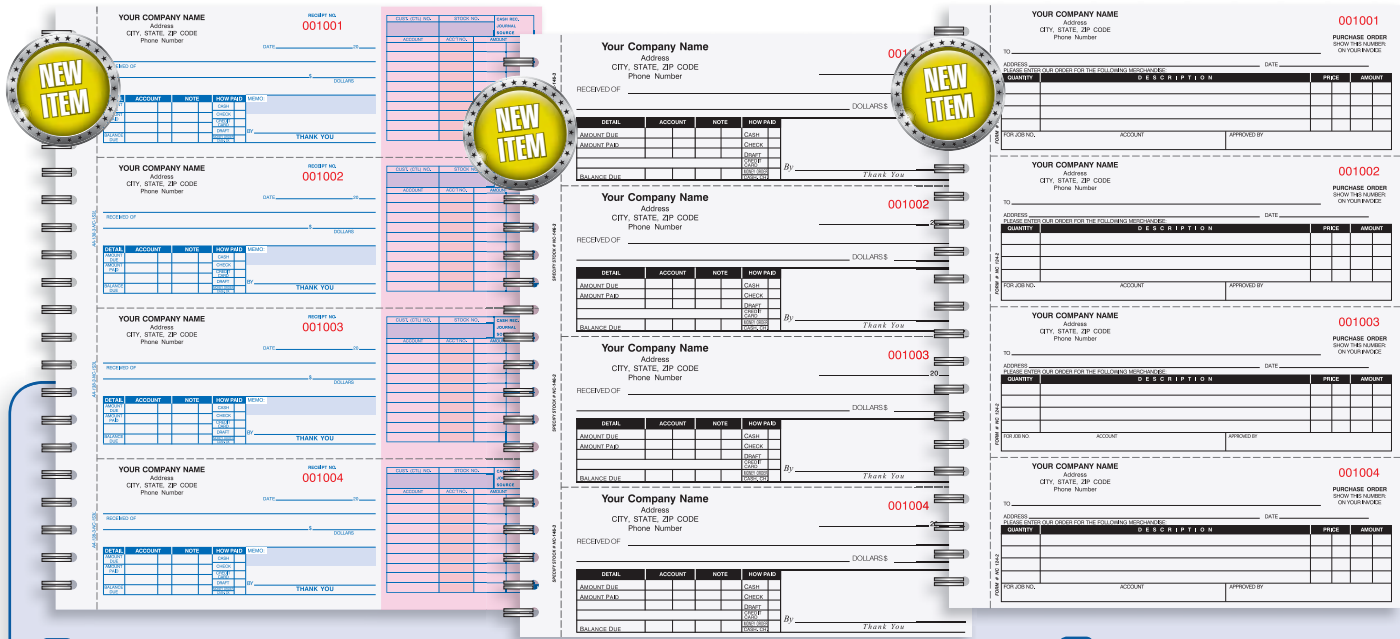

A AA-138 - Wire Bound Book
 Cash Receipt Book, 8 1/4" x 11" overall
 Receipt size Pt 1: 5 1/8" x 2 3/4", Pt 2 & 3: 8 1/8" x 2 3/4"
 Imprint area 3/16" x 2 1/2"
 Pt-1 does not have "Over \$10,000 file form IRS-8300"
 3 pt-200 receipts per book
 4 pt-200 receipts per book

B NC-146 - Wire Bound Book
 Cash Receipt Book, 8 1/4" x 11" overall
 Receipt size 7 1/2" x 2 3/4"
 Imprint area 3/16" x 4 1/8"
 2 pt-200 receipts per book
 3 pt-200 receipts per book

C NC-124 - Wire Bound Book
 Purchase Order Book, 8 1/4" x 11" overall
 Receipt size 7 1/2" x 2 3/4"
 Imprint area 1/2" x 5 1/2"
 2 pt-200 receipts per book
 3 pt-200 receipts per book

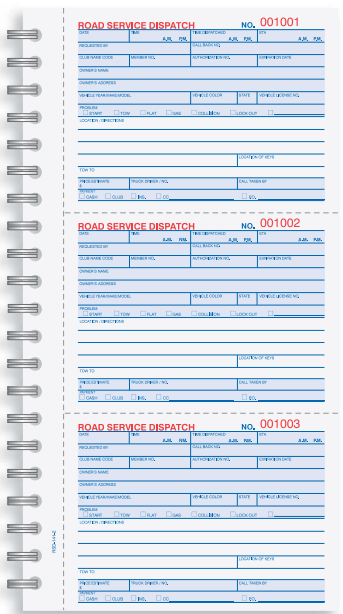

D RSD-141 - Wire Bound Book
 Road Service Dispatch Book, 5 3/4" x 11" overall
 Receipt size 5" x 3 3/8"
 150 sets per book

A AA-138 - Cash Receipt Book

Cat. No.	Pts.	Wt. per 5 Bks	Carbonless Lot Prices				
			5 Bks	10 Bks	15 Bks	25 Bks	50 Bks
138-3	3	6#	124.08	197.92	270.39	390.68	718.88
138-4	4	8#	236.09	344.00	461.00	674.18	1,257.53
Blank Lot Prices							
138-3	3	6#	115.50	184.33	251.50	363.76	668.35
138-4	4	8#	194.25	283.00	379.26	554.59	1,035.02

B NC-146 - Cash Receipt Book

Cat. No.	Pts.	Wt. per 5 Bks	Carbonless Lot Prices				
			5 Bks	10 Bks	15 Bks	25 Bks	50 Bks
146-2	2	5#	81.75	128.67	171.00	248.75	458.34
146-3	3	6#	108.92	171.17	228.00	332.50	610.83
Blank Lot Prices							
146-2	2	5#	75.92	119.50	158.75	232.09	425.84
146-3	3	6#	101.25	159.50	212.25	309.17	569.17

C NC-124 - Purchase Order Book

Cat. No.	Pts.	Wt. per 5 Bks	Carbonless Lot Prices				
			5 Bks	10 Bks	15 Bks	25 Bks	50 Bks
124-2	2	5#	81.75	128.67	171.00	248.75	458.34
124-3	3	7#	108.92	171.17	228.00	332.50	610.83
Blank Lot Prices							
124-2	2	5#	75.92	119.50	158.75	232.09	425.84
124-3	3	7#	101.25	159.50	212.25	309.17	569.17

D RSD-141 - Road Service Dispatch Book

Cat. No.	Pts.	Wt. per 5 Bks	Carbonless Lot Prices				
			5 Bks	10 Bks	15 Bks	25 Bks	50 Bks
141-2	2	5#	76.91	133.69	180.80	298.64	592.12

NOTE:
 Multi-part Color Sequence

1 Day Blank **3 Day Imprint**
Shipping

Colors correspond to sequence and number of parts selected in your order unless otherwise specified.

Not available imprinted. No choice of starting number. (R)

UNALTERABLE CARBONLESS PAPER • NO CARBON IS REQUIRED

ODOMETER DISCLOSURE STATEMENT

FEDERAL LAW (AND STATE LAW, IF APPLICABLE) REQUIRES THAT YOU STATE THE MILEAGE UPON TRANSFER OF OWNERSHIP. FAILURE TO COMPLETE OR PROVIDING A FALSE STATEMENT MAY RESULT IN FINES AND/OR IMPRISONMENT.

I, _____ STATE THAT
(TRANSFEROR'S NAME • SELLER • PRINT)

THE ODOMETER NOW READS _____ (NO TENTHS) MILES AND TO THE BEST OF MY KNOWLEDGE THAT IT REFLECTS THE ACTUAL MILEAGE OF THE VEHICLE DESCRIBED BELOW, UNLESS ONE OF THE FOLLOWING STATEMENTS IS CHECKED.

(1) I HEREBY CERTIFY THAT TO THE BEST OF MY KNOWLEDGE THE ODOMETER READING REFLECTS THE AMOUNT OF MILEAGE IN EXCESS OF ITS MECHANICAL LIMITS.

(2) I HEREBY CERTIFY THAT THE ODOMETER READING IS NOT THE ACTUAL MILEAGE. **WARNING • ODOMETER DISCREPANCY.**

MAKE	MODEL	BODY TYPE
VEHICLE IDENTIFICATION NO.	YEAR	DEALER STOCK NO.

TRANSFEROR'S SIGNATURE (SELLER)
X _____
(PRINTED NAME)

TRANSFEROR'S STREET ADDRESS (SELLER)

(CITY) (STATE) (ZIP CODE)

DATE OF STATEMENT _____

TRANSFEEE'S SIGNATURE (BUYER)
X _____
(PRINTED NAME)

TRANSFEEE'S NAME (BUYER)

(CITY) (STATE) (ZIP CODE)

TRANSFEEE'S STREET ADDRESS

(CITY) (STATE) (ZIP CODE)

800 REV. 9/98 ORIGINAL

UNALTERABLE CARBONLESS PAPER • NO CARBON IS REQUIRED

ODOMETER DISCLOSURE STATEMENT

FEDERAL LAW (AND STATE LAW, IF APPLICABLE) REQUIRES THAT YOU STATE THE MILEAGE UPON TRANSFER OF OWNERSHIP. FAILURE TO COMPLETE OR PROVIDING A FALSE STATEMENT MAY RESULT IN FINES AND/OR IMPRISONMENT.

I, _____ STATE THAT
(TRANSFEROR'S NAME • SELLER • PRINT)

THE ODOMETER NOW READS _____ (NO TENTHS) MILES AND TO THE BEST OF MY KNOWLEDGE THAT IT REFLECTS THE ACTUAL MILEAGE OF THE VEHICLE DESCRIBED BELOW, UNLESS ONE OF THE FOLLOWING STATEMENTS IS CHECKED.

(1) I HEREBY CERTIFY THAT TO THE BEST OF MY KNOWLEDGE THE ODOMETER READING REFLECTS THE AMOUNT OF MILEAGE IN EXCESS OF ITS MECHANICAL LIMITS.

(2) I HEREBY CERTIFY THAT THE ODOMETER READING IS NOT THE ACTUAL MILEAGE. **WARNING • ODOMETER DISCREPANCY.**

MAKE	MODEL	BODY TYPE
VEHICLE IDENTIFICATION NO.	YEAR	DEALER STOCK NO.

TRANSFEROR'S SIGNATURE (SELLER)
X _____
(PRINTED NAME)

TRANSFEROR'S STREET ADDRESS (SELLER)

(CITY) (STATE) (ZIP CODE)

DATE OF STATEMENT _____

TRANSFEEE'S SIGNATURE (BUYER)
X _____
(PRINTED NAME)

TRANSFEEE'S NAME (BUYER)

(CITY) (STATE) (ZIP CODE)

TRANSFEEE'S STREET ADDRESS

(CITY) (STATE) (ZIP CODE)

800 REV. 9/98 ORIGINAL

G MCH-350, MCH-351, MCH-352, MCH-353
Mega Car Hanger, 8½" x 11"
Imprint area 8" x 9"

4TH OF JULY BLOWOUT SALE

WAS \$ _____

SALE PRICE \$ _____

E OSCC-669 - Snap-A-Part
Odometer Disclosure Statement, 8½" x 11"

F OSCC-668 - Snap-A-Part
Odometer Disclosure Statement
5½" x 8½"

E OSCC-669 - Odometer Disclosure Statement

Cat. No.	Pts.	Wt. per 1000	Carbonless Lot Prices				
			250	500	1000	2000	3000
OSCC-669-3	3	25#	82.21	128.91	226.56	422.40	621.45

Not available imprinted or numbered. (R)

F OSCC-668 - Odometer Disclosure Statement

Cat. No.	Pts.	Wt. per 1000	Carbonless Lot Prices				
			250	500	1000	2000	3000
OSCC-668-3	3	13#	76.08	103.95	164.16	281.58	404.09

Not available imprinted or numbered. (R)

G MCH-350, MCH-351, MCH-352, MCH-353 - Mega Car Hanger - 13 PT CSU

Cat. No.	Color	Pts.	Wt. per 1000	Lot Prices					
				250	500	1000	2000	5000	10000
MCH-350-1	Red	1	42#	130.78	170.20	247.68	482.40	1,138.23	2,194.87
MCH-351-1	Yellow	1	42#	130.78	170.20	247.68	482.40	1,138.23	2,194.87
MCH-352-1	Pink	1	42#	130.78	170.20	247.68	482.40	1,138.23	2,194.87
MCH-353-1	Green	1	42#	130.78	170.20	247.68	482.40	1,138.23	2,194.87

No back printing available. Price includes black ink. Imprint charge for color other than black is \$30.63(R) per lot. (R)
See page 107 for available imprint colors.

H MCH-354 - 2 Color Mega Car Hanger - 10 PT CSU

Cat. No.	Color	Pts.	Wt. per 1000	Lot Prices					
				250	500	1000	2000	5000	10000
MCH-354-1	White	1	50#	130.78	170.20	247.68	482.40	1,138.23	2,194.87

No back printing available. See page 107 for available imprint colors. (R)

I CT-300 - 3 Section Claim Ticket

Cat. No.	Pts.	Wt. per 1000	Lot Prices				
			500	1000	2000	5000	10000
CT-300	1	15#	89.80	135.15	254.64	589.52	1,138.23

No back printing available. Imprint available in red, black, blue or green. (R)

J RSB-142 - Road Service Book

Cat. No.	Pts.	Wt. per 10 Bks	Carbonless Lot Prices				
			10 Bks	15 Bks	25 Bks	50 Bks	100 Bks
RSB-142-2	2	6#	139.00	187.25	286.68	514.33	994.71
RSB-142-3	3	7#	146.59	197.24	303.42	570.08	1,061.68

(R)

H MCH-354 - Your custom file printed

2 color on white
Mega Car Hanger, 8½" x 11"
Imprint area 8" x 9"

000
VEHICLE NUMBER

000
KEY TAG

000
YOUR COMPANY NAME
Address
CITY, STATE, ZIP CODE
Phone Number

YOUR COMPANY NAME
Address
CITY, STATE, ZIP CODE
Phone Number
Advertising Line
001001

ROAD SERVICE

DATE: _____ TIME: _____ FAX REQUESTED BY: _____
LOCATION OF VEHICLE: _____

PROBLEM REPORTED: _____ MILEAGE: _____ SERVICE TIME: _____ EXTRA PERSON: _____

START: _____ END: _____ TOTAL: _____

YEAR: _____ MAKE: _____ MODEL: _____

PROBLEMS REPORTED: FLAT TIRE, BATTERY DEAD, BLOWN FUSE, BATTERY BLOBS, RECOVERY, SERVICE TOWED TO _____

SERVICES RENDERED: AIRSERT TOW, FLAT REPAIR, BATTERY REPAIR, BATTERY BLOBS, BATTERY BLOBS, BATTERY BLOBS, BATTERY BLOBS

SPECIAL EQUIPMENT: CHARGE LINE WIRING, DUAL LINE WIRING, BATTERY BLOBS, BATTERY BLOBS, BATTERY BLOBS

INDICATE DAMAGED AREAS ON VEHICLE: _____

PROVIDER'S SIGNATURE: _____ APPROVED SIGNATURE: _____ TOTAL: _____

800 REV. 9/98 ORIGINAL

J RSB-142
Road Service Book, 5½" x 8½"
Imprint area 1" x 3"
50 sets per book

I CT-300
3 Section Claim Ticket, 4" x 8"
Imprint area: top section - 2" x 3½" (up to 1¾" number)
middle section - 1½" x 3" (up to ¾" number)
bottom section - 1½" x 3½" (up to ¾" number)

A BGS-685 - Snap-A-Part
Buyer's Guide Warranty, 8½" x 11"
Imprint area 1" x 3½"

BUYERS GUIDE

IMPORTANT: Spoken promises are difficult to enforce. Ask the dealer to put all promises in writing. Keep this form.

YOUR COMPANY NAME
Address
CITY, STATE, ZIP CODE
Phone Number
Advertising Line

WARRANTIES FOR THIS VEHICLE:

AS IS - NO WARRANTY

YOU WILL PAY ALL COSTS FOR ANY REPAIRS. THE DEALER ASSUMES NO RESPONSIBILITY FOR ANY ORAL STATEMENTS ABOUT THE VEHICLE.

WARRANTY

FULL LIMITED WARRANTY. The dealer will pay _____% of the labor and _____% of the parts for the covered systems that fail during the warranty period. Ask the dealer for a copy of the warranty document for a full explanation of warranty coverage, exclusions, and the dealer's repair obligations. Under state law, "implied warranties" may give you even more rights.

SYSTEMS COVERED: _____ DURATION: _____

SERVICE CONTRACT. A service contract is available at an extra charge on this vehicle. Ask for details as to coverage, deductible, price, and exclusions. If you buy a service contract within 90 days of the time of sale, state law "implied warranties" may give you additional rights.

PRE PURCHASE INSPECTION: ASK THE DEALER IF YOU MAY HAVE THIS VEHICLE INSPECTED BY YOUR MECHANIC EITHER ON OR OFF THE LOT.

SEE THE BACK OF THIS FORM for important additional information, including a list of some major defects that may occur in used motor vehicles.

PRINTED IN U.S.A.

A BGS-885 - Snap-A-Part
Buyer's Guide Warranty w/Mirror Hanger, 8½" x 11"
Imprint area 1" x 3½"

BUYERS GUIDE

IMPORTANT: Spoken promises are difficult to enforce. Ask the dealer to put all promises in writing. Keep this form.

YOUR COMPANY NAME
Address
CITY, STATE, ZIP CODE
Phone Number
Advertising Line

WARRANTIES FOR THIS VEHICLE:

AS IS - NO WARRANTY

YOU WILL PAY ALL COSTS FOR ANY REPAIRS. THE DEALER ASSUMES NO RESPONSIBILITY FOR ANY REPAIRS REGARDLESS OF ANY ORAL STATEMENTS ABOUT THE VEHICLE.

WARRANTY

FULL LIMITED WARRANTY. The dealer will pay _____% of the labor and _____% of the parts for the covered systems that fail during the warranty period. Ask the dealer for a copy of the warranty document for a full explanation of warranty coverage, exclusions, and the dealer's repair obligations. Under state law, "implied warranties" may give you even more rights.

SYSTEMS COVERED: _____ DURATION: _____

SERVICE CONTRACT. A service contract is available at an extra charge on this vehicle. Ask for details as to coverage, deductible, price, and exclusions. If you buy a service contract within 90 days of the time of sale, state law "implied warranties" may give you additional rights.

PRE PURCHASE INSPECTION: ASK THE DEALER IF YOU MAY HAVE THIS VEHICLE INSPECTED BY YOUR MECHANIC EITHER ON OR OFF THE LOT.

SEE THE BACK OF THIS FORM for important additional information, including a list of some major defects that may occur in used motor vehicles.

PRINTED IN U.S.A.

GUÍA DEL COMPRADOR

IMPORTANTE: Las promesas verbales son difíciles de hacer cumplir. Solicite al vendedor que ponga todas las promesas por escrito. Conserve este formulario.

MARKA DEL VEHICULO: _____ MODELO: _____ AÑO: _____ NUMERO DE IDENTIFICACION: _____

WARRANTIES FOR THIS VEHICLE:

COMO ESTÁ - SIN GARANTÍA

LISTED PAGARÁ TODOS LOS GASTOS DE CUALQUIER REPARACIÓN QUE SEA NECESARIA. El vendedor no asume ninguna responsabilidad por cualquier reparación, sean cuáles sean las declaraciones verbales que haya hecho acerca del vehículo.

GARANTÍA

COMPLETA LIMITADA. El vendedor pagará el _____% de la mano de obra y el _____% de los repuestos de los sistemas cubiertos que dejen de funcionar durante el periodo de garantía. Pida al vendedor una copia del documento de garantía donde se detallan detalladamente la cobertura de la garantía, exclusiones y las obligaciones que tiene el vendedor de realizar reparaciones. Conserve a la vez esta lista de "garantías implícitas" puesto que la ley otorga más derechos.

SYSTEMAS CUBIERTOS POR LA GARANTIA: _____ DURACION: _____

CONTRATO DE SERVICIO. Este vehículo tiene disponible un contrato de servicio a un precio adicional. Pida los detalles acerca de cobertura, deducible, precio y exclusiones. Si adquiere un contrato de servicio dentro de los 90 días del momento de la venta, las "garantías implícitas" de acuerdo a la ley otorga más derechos.

INSPECCION PREVIA A LA COMPRA: PREGUNTE AL VENDEDOR SI PUEDE USTED TRAER UN MECANICO PARA QUE INSPECCIONE EL AUTOMOVIL O LLEVAR EL AUTOMOVIL PARA QUE ESTE LO INSPECCIONE EN SU TALLER.

VEASE EL DORSO DE ESTE FORMULARIO donde se proporciona información adicional sobre inspecciones, incluyendo una lista de algunos de los principales defectos que pueden ocurrir en vehículos usados.

PRINTED IN U.S.A.

C BGS-565 - Snap-A-Part
Spanish Buyer's Guide Warranty
As is - no warranty, 7½" x 12"

BGS-575 - Snap-A-Part
Implied warranties only, 7½" x 11½"
Imprint area 1" x 3½"

D BGS-555 - Snap-A-Part
Buyer's Guide Warranty, 7½" x 11½"
Imprint area 1" x 3½"

B BGS-675 - Snap-A-Part
Buyer's Guide Warranty, 8½" x 11"
Imprint area 1" x 3½"

BUYERS GUIDE

IMPORTANT: Spoken promises are difficult to enforce. Ask the dealer to put all promises in writing. Keep this form.

YOUR COMPANY NAME
Address
CITY, STATE, ZIP CODE
Phone Number
Advertising Line

WARRANTIES FOR THIS VEHICLE:

IMPLIED WARRANTY

This means that the dealer does not make any specific promises to fix things that need repair when you buy the vehicle or after the time of sale. But, state law "implied warranties" may give you some rights to have the dealer take care of service problems that were not apparent when you bought the vehicle.

WARRANTY

FULL LIMITED WARRANTY. The dealer will pay _____% of the labor and _____% of the parts for the covered systems that fail during the warranty period. Ask the dealer for a copy of the warranty document for a full explanation of warranty coverage, exclusions, and the dealer's repair obligations. Under state law, "implied warranties" may give you even more rights.

SYSTEMS COVERED: _____ DURATION: _____

SERVICE CONTRACT. A service contract is available at an extra charge on this vehicle. Ask for details as to coverage, deductible, price, and exclusions. If you buy a service contract within 90 days of the time of sale, state law "implied warranties" may give you additional rights.

PRE PURCHASE INSPECTION: ASK THE DEALER IF YOU MAY HAVE THIS VEHICLE INSPECTED BY YOUR MECHANIC EITHER ON OR OFF THE LOT.

SEE THE BACK OF THIS FORM for important additional information, including a list of some major defects that may occur in used motor vehicles.

PRINTED IN U.S.A.

B BGS-775 - Snap-A-Part
Buyer's Guide Warranty, w/Mirror Hanger, 8½" x 11"
Imprint area 1" x 3½"

A BGS-685, 885 - Buyer's Guide Warranty

Cat. No.	Wt. Pts.	Carbonless Lot Prices					
		per 1000	250	500	1000	2000	3000
BGS-685-2	2	16#	102.80	156.36	270.14	495.61	727.64
885-3†	3	16#	117.26	183.82	324.12	604.08	889.36

Available numbered in red by request. (R)
†Mirror hanger.

B BGS-675, 775 - Buyer's Guide Warranty

Cat. No.	Wt. Pts.	Carbonless Lot Prices					
		per 1000	250	500	1000	2000	3000
BGS-675-2	2	16#	102.80	156.36	270.14	495.61	727.64
775-3†	3	16#	117.26	183.82	324.12	604.08	889.36

Available numbered in red by request. (R)
†Mirror hanger.

C BGS-565, 575 - Spanish Buyer's Guide Warranty

Cat. No.	Wt. Pts.	Carbonless Lot Prices					
		per 1000	250	500	1000	2000	3000
BGS-565-2	2	14#	102.80	156.36	270.14	495.61	727.64
575-2	2	14#	102.80	156.36	270.14	495.61	727.64

Available numbered in red by request. (R)

D BGS-555 - Buyer's Guide Warranty

Cat. No.	Wt. Pts.	Carbonless Lot Prices					
		per 1000	250	500	1000	2000	3000
BGS-555-2	2	14#	102.80	156.36	270.14	495.61	727.64

Available numbered in red by request. (R)

NOTE:

1 Day Blank **3 Day Imprint**

Shipping



E Floor Mats, Car Design

Size	Imprint
20" x 14"	3/4" x 13"
19" x 17"	3/4" x 12"
22" x 17"	3/4" x 15"

E Floor Mats, Car Design

Cat. No.	FM- Size	Color	Wt. per 1000	Lot Prices				
				250	500	1000	2000	3000
9944	20" x 14"	Red	44#	150.64	175.29	210.86	314.65	420.94
9945	19" x 17"	Red	48#	153.66	178.93	215.02	321.10	429.36
9946	22" x 17"	Red	52#	156.78	182.36	219.39	327.55	437.58
9934	20" x 14"	Blue	44#	150.64	175.29	210.86	314.65	420.94
9935	19" x 17"	Blue	48#	153.66	178.93	215.02	321.10	429.36
9936	22" x 17"	Blue	52#	156.78	182.36	219.39	327.55	437.58

Imprint available in black ink only. For blank floor mats, deduct 30%. (R)

F Floor Mats, Footprints Design

Cat. No.	FM- Size	Color	Wt. per 1000	Lot Prices				
				250	500	1000	2000	3000
9941	20" x 14"	Red	44#	150.64	175.29	210.86	314.65	420.94
9942	19" x 17"	Red	48#	153.66	178.93	215.02	321.10	429.36
9931	20" x 14"	Blue	44#	150.64	175.29	210.86	314.65	420.94
9932	19" x 17"	Blue	48#	153.66	178.93	215.02	321.10	429.36
9933	22" x 17"	Blue	52#	156.78	182.36	219.39	327.55	437.58

Imprint available in black ink only. For blank floor mats, deduct 30%. (R)

G Truck Floor Mats, Footprints Design

Cat. No.	FM- Size	Color	Wt. per 1000	Lot Prices				
				250	500	1000	2000	3000
9923	17" x 22"	Blue	52#	156.78	182.36	219.39	327.55	437.58
9924	17" x 22"	Red	52#	156.78	182.36	219.39	327.55	437.58

Imprint available in black ink only. For blank floor mats, deduct 30%. (R)

H Truck Floor Mats, Truck Design

Cat. No.	FM- Size	Color	Wt. per 1000	Lot Prices				
				250	500	1000	2000	3000
9921	17" x 22"	Blue	52#	156.78	182.36	219.39	327.55	437.58
9922	17" x 22"	Red	52#	156.78	182.36	219.39	327.55	437.58

Imprint available in black ink only. For blank floor mats, deduct 30%. (R)

NOTE:



Includes your company's name, address and phone number in one of four colors! For blank forms, subtract 30%.



Colors correspond to sequence and number of parts selected in your order unless otherwise specified.



Choose a six-digit starting number for your imprinted form at no extra charge! Otherwise, we will start with 001001. Four, five and seven-digit numbering available at an additional charge. See page 142 for pricing.

Blank forms will be sequentially numbered unless specified otherwise.



! All Floor Mats printed on 24# bond.



F Floor Mats, Footprints Design

Size	Imprint
20" x 14"	3" x 6"
19" x 17"	3" x 6"
22" x 17"	4" x 7 1/4"

G Truck Mats, Footprints Design

Size	Imprint
17" x 22"	3 1/4" x 15"

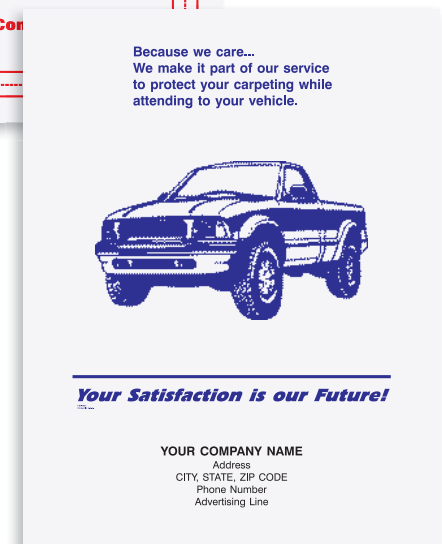

H Truck Mats, Truck Design

Size	Imprint
17" x 22"	3 1/4" x 15"

Pest Control Service Agreement

YOUR COMPANY NAME
Address
CITY, STATE, ZIP CODE
Phone Number
Advertising Line 001001

TERMINATION: _____ SERVICE GUARANTEE: _____

INITIAL SERVICE CHARGE: \$ _____ BY COMPANY: _____ DATE: _____

MONTHLY/QUARTERLY PAYMENTS: \$ _____ FOR CUSTOMER: _____ DATE: _____

SERVICE GUARANTEE: We agree to apply chemicals to control above-named pests in accordance with terms and conditions of this Service Agreement. All labor and materials will be furnished to provide the most efficient pest control and maximum safety required by federal, state and city regulations.

SERVICE RENEWAL: This agreement shall be for an initial period of one year, and will renew itself annually unless either party cancels this agreement by giving thirty days written notice before any expiration date.

ANNUAL AGREEMENT CHARGE: \$ _____ BY COMPANY: _____ DATE: _____

INITIAL SERVICE CHARGE: \$ _____ BY COMPANY: _____ DATE: _____

MONTHLY/QUARTERLY PAYMENTS: \$ _____ FOR CUSTOMER: _____ DATE: _____

YOUR COMPANY NAME

Address
CITY, STATE, ZIP CODE
Phone Number
Advertising Line

DATE: _____ TIME: _____ DAY: _____ ACCOUNT NO.: _____ PHONE NO.: _____

ORDER TYPE: REGULAR REORDER REPAIR

ORDER: HOME COMMERCIAL OUTDOOR

CITY STATE: _____

TERMS: ANNUALLY 6 MONTHS 3 MONTHS

INSPECTION TREATMENT

TARGET PESTS: _____ DATE TREATED: _____ APPLICATION METHOD: _____ APPLICATION DATE: _____

CHEMICALS USED: _____ AMOUNT: _____ %: _____ EPA NUMBER: _____

DESCRIPTION: _____ AMOUNT: _____

SUB-TOTAL: _____ TAX: _____ TOTAL: _____ ACCOUNT BALANCE: _____

ORDERED BY: _____ PHONE NO.: _____ CASH AMOUNT PAID: _____

CUSTOMER SERVICE: _____ CHECK # _____ BALANCE DUE: _____

SERVICE ORDER / INVOICE 001001

YOUR COMPANY NAME

Address
CITY, STATE, ZIP CODE
Phone Number

DATE: _____ TIME: _____ DAY: _____

ORDER TYPE: REG. HOME RES. COMM. REPAIR OUTDOOR

CITY STATE: _____

ORDER TYPE: ANNUALLY 6 MONTHS 3 MONTHS

INSPECTION TREATMENT

TARGET PESTS: _____ DATE TREATED: _____ APPLICATION METHOD: _____ APPLICATION DATE: _____

CHEMICALS USED: _____ AMOUNT: _____ %: _____ EPA NUMBER: _____

DESCRIPTION: _____ AMOUNT: _____

SUB-TOTAL: _____ TAX: _____ TOTAL: _____ ACCOUNT BALANCE: _____

ORDERED BY: _____ PHONE NO.: _____ CASH AMOUNT PAID: _____

CUSTOMER SERVICE: _____ CHECK # _____ BALANCE DUE: _____

SERVICE REPORT 001001

C PC-881 - Wrap Around Book
Pest Control Service Report Book
3 1/2" x 6 1/4"
Imprint area 3/4" x 3"
50 sets per book.

B PCCC-880 - Snap-A-Part
Pest Control Service Order/Invoice
5 1/2" x 8 1/2"
Imprint area 3/4" x 5"

A PCCC-882 - Snap-A-Part
Pest Control Service Agreement, 8 1/2" x 11"
Imprint area 1 1/4" x 6"

A PCCC-882 - Pest Control Service Agreement

Cat. No.	Pts.	Wt. per 1000	Carbonless Lot Prices				
			250	500	1000	2000	3000
882-2	2	16#	94.07	137.54	232.18	418.96	606.58

Envelopes available on page 100. (9906) (R)

B PCCC-880 - Pest Control Service Order/Invoice

Cat. No.	Pts.	Wt. per 1000	Carbonless Lot Prices				
			250	500	1000	2000	3000
880-3	3	13#	89.91	129.84	215.54	383.19	558.43

Envelopes available on page 101. (9919) (R)

C PC-881 - Pest Control Service Report Book

Cat. No.	Pts.	Wt. per 10 Bks	Carbonless Lot Prices			
			10 Bks	15 Bks	25 Bks	50 Bks
881-3	3	4#	124.44	160.63	241.12	429.47

(R)

D PCICC-879 - Pest Control Inspection

Cat. No.	Pts.	Wt. per 1000	Carbonless Lot Prices				
			250	500	1000	2000	3000
879-2	2	9#	77.43	105.82	168.32	293.12	415.32

Numbered by request only. (R)

PEST CONTROL INSPECTION

YOUR COMPANY NAME
Address
CITY, STATE, ZIP CODE
Phone Number

DATE: _____ TIME: _____ DAY: _____

TERMINATION: _____

INITIAL SERVICE CHARGE: \$ _____ BY COMPANY: _____ DATE: _____

MONTHLY/QUARTERLY PAYMENTS: \$ _____ FOR CUSTOMER: _____ DATE: _____

SERVICE GUARANTEE: We agree to apply chemicals to control above-named pests in accordance with terms and conditions of this Service Agreement. All labor and materials will be furnished to provide the most efficient pest control and maximum safety required by federal, state and city regulations.

SERVICE RENEWAL: This agreement shall be for an initial period of one year, and will renew itself annually unless either party cancels this agreement by giving thirty days written notice before any expiration date.

ANNUAL AGREEMENT CHARGE: \$ _____ BY COMPANY: _____ DATE: _____

INITIAL SERVICE CHARGE: \$ _____ BY COMPANY: _____ DATE: _____

MONTHLY/QUARTERLY PAYMENTS: \$ _____ FOR CUSTOMER: _____ DATE: _____

D PCICC-879 - Snap-A-Part
Pest Control Inspection, 8 1/2" x 5 1/2"
Imprint area 3/4" x 3"

NOTE:



Includes your company's name, address and phone number in one of four colors! For blank forms, subtract 30%.



Colors correspond to sequence and number of parts selected in your order unless otherwise specified.



Choose a six-digit starting number for your imprinted form at no extra charge! Otherwise, we will start with 001001. Four, five and seven-digit numbering available at an additional charge. See page 142 for pricing.

Blank forms will be sequentially numbered unless specified otherwise.

Advertise with Business Card Magnets from Page 106.

LPCC 792-A
Printed in U.S.A.

YOUR COMPANY NAME
Address
CITY, STATE, ZIP CODE
Phone Number
Advertising Line

Page No. _____ of _____ Pages

LANDSCAPING PROPOSAL

TO: _____

PHONE _____ DATE _____

CONTRACTOR LICENSE NO.	JOB PHONE NO.
JOB NAME / NO.	
JOB LOCATION	
LANDSCAPE ARCHITECT	DATE OF PLANS
APPROXIMATE STARTING DATE	APPROXIMATE COMPLETION DATE

We hereby submit specifications and estimates for landscaping as follows:

Put Your Disclaimer Here at No Extra Charge!

We Propose hereby to furnish material and labor - complete in accordance with above specifications, for the sum of: _____ dollars (\$ _____).

Payment to be made as follows: _____

Authorized Signature: _____ Date: _____

Acceptance of Proposal: The above prices, specifications and conditions are satisfactory and are hereby accepted. You are authorized to do the work as specified. Payment will be made as outlined above.

Signature: _____ Date: _____ Signature: _____ Date: _____

A LPCC-792 - Snap-A-Part
Landscaping Proposal, 8½" x 11"
Imprint area 1" x 4"
Disclaimer imprint area 3½" x 2½"

LPCCO 794-A
Printed in U.S.A.

YOUR COMPANY NAME
Address
CITY, STATE, ZIP CODE
Phone Number
Advertising Line

001001

LANDSCAPING Work Order/Invoice

TO: _____

TERMS: _____

CHECKMARKS DENOTE: WORK COMPLETED WORK TO BE DONE

PREPARATION	PLANTING	MULCHING	EDGING/BORDERS	PRUNING/TRIMMING	FERTILIZING
GRASS: PLANNING	SHRUBS				
GRASSING	HEDGES				
SOIL PREPARATION	TREES				
LAWN INSTALLATION	FLOWERING PLANTS				
SOIL					
SEEDING					
LAWN MAINTENANCE					
MOWING					
FERTILIZING					
WEED					
TRIMMING					
EDGING					
SPRINKLER					
IRRIGATION					
PRUNING					
INSECT AND WEED CONTROL					
HYDROSEEDING					
MASONRY & STONEWORK					
STONE WALL					
STAIRS					
TERRACING					
WALKWAY					
PAVING					
WATER FEATURES					
INSTALL POND					
INSTALL WATER FOUNTAIN					
INSTALL SPRINKLER SYSTEM					
IRRIGATION AND DRAINAGE					
MISCELLANEOUS					
SPRINK / FALL CLEANUP					
ROTILLAGE					
POST HOLE DRILLING					
STUMP REMOVAL & CHIPPING					
MISC TREE WORK					
DEMOLITION					

Thank You!

C LWOC-794 - Snap-A-Part
Landscaping Work Order, 8½" x 11"
Imprint area 1" x 4"
Includes snow removal.



B FH-9977, 9979, 9980
Forms Holder
Top or Side Opening

A LPCC-792 - Landscaping Proposal

Cat. No.	Pts.	Wt. per 1000	Carbonless Lot Prices				
			250	500	1000	2000	3000
792-3	3	25#	117.88	185.80	326.82	609.18	897.47

Numbered by request only. (R)
Envelopes available on page 100. (9906, 9907)

B FH-9977, 9979, 9980 - Forms Holder

Cat. No.	Wt. each	For Forms		Price Each
		Up To	Opens	
9977	2#	5½" x 9½"	Top	35.52
9979	3#	8½" x 12"	Top	54.44
9980	3#	8½" x 12"	Side	55.38

(R)

C LWOC-794 - Landscaping Work Order

Cat. No.	Pts.	Wt. per 1000	Carbonless Lot Prices				
			250	500	1000	2000	3000
794-3	3	35#	118.20	191.83	340.55	652.86	966.11

Last part is manila tag. (R)
Envelopes available on page 100. (9906, 9907)

NOTE:



Includes your company's name, address and phone number in one of four colors! For blank forms, subtract 30%.



Colors correspond to sequence and number of parts selected in your order unless otherwise specified.



Choose a six-digit starting number for your imprinted form at no extra charge! Otherwise, we will start with 001001. Four, five and seven-digit numbering available at an additional charge. See page 142 for pricing.

Blank forms will be sequentially numbered unless specified otherwise.

- See page 96 for Document Jackets designed for your business.
- Phantoms are enhanced for display purpose.

D LWO-893
Landscaping Work Order/Invoice, 8½" x 11"
Imprint area 1" x 4"

E LE-791
Landscaping Estimate, 8½" x 11"
Includes snow removal.

D LWO-893 - Landscaping Work Order/Invoice

Cat. No.	Wt.	Lot Prices					
LWO-	Pts.	per 1000	250	500	1000	2000	3000
893-1	1	11#	76.80	98.96	128.08	220.43	250.80

Envelopes available on page 100. (9906, 9909, 9907) (R)

E LE-791 - Landscaping Estimate

Cat. No.	Wt.	Lot Prices					
LE-	Pts.	per 1000	250	500	1000	2000	3000
791-1	1	19#	64.84	95.32	148.88	237.59	328.69

Not available imprinted or numbered. Printed on manila stock. (R)
Envelopes available on page 100. (9906)

F LMCC-793 - Lawn Maintenance Invoice

Cat. No.	Wt.	Carbonless Lot Prices					
LMCC-	Pts.	per 1000	250	500	1000	2000	3000
793-3	3	13#	89.91	129.84	215.54	383.19	558.43

Envelopes available on pages 100-101. (9919, 9913, 9915) (R)

F LMCC-793 - Snap-A-Part
Lawn Maintenance Invoice, 5½" x 8½"
Imprint area 1" x 3"
Includes snow removal.

NOTE:

1
Day
Blank
Shipping

3
Day
Imprint

See page 79 for easy to use color-coded Collection Forms. See page 99 to combine with a Business Reply Envelope in a matching color.

Custom cards and envelopes up to 4-color, full bleed.



A **FGC-625**
Florist Gift Card, 3½" x 2¼"
Imprint area 3½" x 2¼"

B **ENV-9868, 9869**
Gift Card Envelopes, 3" x 4½"
Imprint area 3" x 4½"

C-F are Marble Only.

C **WFCC-648 - Snap-A-Part**
Wedding Flower Order Form, 8½" x 13¼"
Imprint area 1½" x 4"

D **GSF-221 - Register Form**
Florist Sales, 5½" x 8½"
Imprint area 1" x 5"

E **GSF-239 - Register Form**
Florist Sales, 4" x 6½"
Imprint area 1" x 3½"

F **GSFCC-639 - Snap-A-Part**
Florist Sales, 5½" x 8½"
Imprint area 1" x 5"

G **GSF-214 - Register Form**
Florist Sales, 5½" x 8½"
Imprint area 1" x 5"

H **GSF-229 - Register Form**
Florist Sales, 4" x 6½"
Imprint area 1" x 3½"

I **GSFCC-649 - Snap-A-Part**
Florist Sales, 5½" x 8½"
Imprint area 1" x 5"

A **FGC-625 - Florist Gift Card**

Cat. No.	Size	Wt. per 1000	Imprinted Lot Prices			
			100	250	500	1000
625-1	3½" x 2¼"	3#	20.83	41.67	62.50	83.33

100# Endurance Velvet Cover (R)

B **ENV-9868, 9869 - Gift Card Envelopes**

Cat. No.	Size	Wt. per 1000	Pts.	Imprinted Lot Prices			
				100	250	500	1000
9868	3" x 4½" Regular	4#	4#	33.33	66.67	100.00	133.33
9869	3" x 4½" Window	4#	4#	37.50	75.00	108.34	141.67

Deduct 30% for blank envelopes. (R)

C **WFCC-648 - Wedding Flower Order Form**

Cat. No.	Pts.	Wt. per 1000	Carbonless Lot Prices				
			250	500	1000	2000	
648-2	2	15#	194.74	263.59	420.94	800.02	1,183.26

Layout grids for ceremony/reception on back. (R)

D **GSF-221 - Florist Sales**

Cat. No.	Pts.	Wt. per 1000	Carbonless Lot Prices				
			250	500	1000	2000	
221-2	2	8#	74.62	97.50	140.56	228.54	315.07
221-3	3	12#	84.40	116.84	178.83	302.80	432.07

(R)

E **GSF-239 - Florist Sales**

Cat. No.	Pts.	Wt. per 1000	Carbonless Lot Prices				
			250	500	1000	2000	
239-2	2	5#	71.60	92.61	125.58	192.98	259.42

(R)

F **GSFCC-639 - Florist Sales**

Cat. No.	Pts.	Wt. per 1000	Carbonless Lot Prices				
			250	500	1000	2000	
639-3	3	13#	94.28	136.08	226.46	402.53	586.92

(R)

G **GSF-214 - Florist Sales**

Cat. No.	Pts.	Wt. per 1000	Carbonless Lot Prices				
			250	500	1000	2000	
214-2	2	8#	74.62	97.50	140.56	228.54	315.07
214-3	3	12#	84.40	116.84	178.83	302.80	432.07

(R)

H **GSF-229 - Florist Sales**

Cat. No.	Pts.	Wt. per 1000	Carbonless Lot Prices				
			250	500	1000	2000	
229-2	2	5#	71.60	92.61	125.58	192.97	259.42
229-3	3	7#	81.17	104.78	149.29	240.60	332.54

(R)

I **GSFCC-649 - Florist Sales**

Cat. No.	Pts.	Wt. per 1000	Carbonless Lot Prices				
			250	500	1000	2000	
649-3	3	13#	94.28	136.08	226.46	402.53	586.92

(R)

YOUR COMPANY NAME
Address
CITY, STATE, ZIP CODE
Phone Number
Advertising Line

ORDER NUMBER	PHONE NUMBER	DATE
NAME		
ADDRESS		
SOLD BY	CASH	CHEQUE
ARTICLE	STOCK NO.	AMOUNT
SPECIAL INSTRUCTIONS		AMOUNT OF SALE
		TAX
		TOTAL
		AMOUNT PAID
		BALANCE

RECEIVED BY

ALL CLAIMS AND RETURNED GOODS MUST BE ACCOMPANIED BY THIS BILL

0001001

PRINTED IN U.S.A.

A GJ-219 - Register Form
Gift/Jewelry, 5½" x 8½"
Imprint area 1" x 5"

A GJ-219 - Gift/Jewelry

Cat. No.	GJ-	Pts.	Wt. per 1000	Carbonless Lot Prices			
				250	500	1000	2000
219-2	2	8#	74.62	97.50	140.56	228.54	315.07
219-3	3	12#	84.40	116.84	178.83	302.80	435.29

(R)

B JRE-9947 - Jewelry Repair Envelope

Cat. No.	JRE-	Pts.	Wt. per 1000	Carbonless Lot Prices			
				250	500	1000	2000
9947	3	24#	174.77	249.65	372.48	729.51	1,018.00

(R)

C JRE-9948 - Jewelry Repair Envelope/Claim Check

Cat. No.	JRE-	Pts.	Wt. per 1000	Carbonless Imprinted Lot Prices			
				100	250	500	1000
9948	3	18#	88.66	136.29	209.92	329.84	619.68

Carbonless Blank Lot Prices								
Cat. No.	JRE-	Pts.	Wt. per 1000	250	500	1000	2000	3000
9948	3	18#	65.47	100.31	155.53	245.60	460.67	

(R)

D GJ-212 - Gift/Jewelry

Cat. No.	GJ-	Pts.	Wt. per 1000	Carbonless Lot Prices			
				250	500	1000	2000
212-2	2	5#	67.03	82.00	111.12	170.92	230.41
212-3	3	6#	73.79	95.32	135.77	219.08	302.48

(R)

E GJ-241 - Gift/Jewelry

Cat. No.	GJ-	Pts.	Wt. per 1000	Carbonless Lot Prices			
				250	500	1000	2000
241-2	2	5#	71.60	92.61	125.58	192.98	259.42
241-3	3	7#	81.17	104.78	149.29	240.60	332.54

(R)

B JRE-9947
Jewelry Repair Envelope, 5½" x 9¼"
Imprint area ¾" x 4½"
Metal clasp provides easy access to envelope.

CLAIM CHECK

Customer Name (Print) 001001

City, State, Zip Customer Charges \$
Deposit \$

Phone Number Balance \$

JEWELRY INFORMATION IDENTIFY CUSTOMER DIAMOND

Complete Description of Merchandise SWATCH

Condition: NEW WORN

WATCH INFORMATION

Case # Serial #

Check one (✓) Buy Sell Trade Repair

Work to be done (Describe completely) Date Received

Date Promised Date Picked Up

THIS STORE IS NOT RESPONSIBLE FOR ARTICLES LEFT OVER 60 DAYS. NO ARTICLES CAN BE PICKED UP WITHOUT THIS RECEIPT. The estimated value and description of the above listed articles are correct to the best of my knowledge. This store is not responsible for the condition of articles or repairs to articles made at this store unless otherwise specified. This store receives these articles for the purpose of repair only and does not function as a dealer of these articles. This store is not responsible for damage, loss or break of these articles unless they are not repaired in this store. Damage due to the store's negligence will be repaired to the actual cost to replace or repair the article and is not to exceed the above stated value. If no value is indicated it is presumed that the value is less than \$1000.

I have read and understand the above terms and conditions. CUSTOMER AGREES WORK AND ITEMS ARE SATISFACTORY. CUSTOMER SIGNATURE DATE

YOUR COMPANY NAME
Address
CITY, STATE, ZIP CODE
Phone Number
Advertising Line

WATCH AND FINE JEWELRY REPAIR ENVELOPE
Use a separate envelope for each item.

PRINTED IN U.S.A.

CLAIM CHECK

NAME

ADDRESS 001001

CITY PHONE

ARTICLE DATE RECEIVED DATE PICKED UP

INSTRUCTIONS

THIS STORE IS NOT RESPONSIBLE FOR ARTICLES LEFT OVER 60 DAYS. NO ARTICLES CAN BE PICKED UP WITHOUT THIS RECEIPT.

TOTAL	
DEPOSIT	
BALANCE	

YOUR COMPANY NAME
Address
CITY, STATE, ZIP CODE
Phone Number
Advertising Line

PRINTED IN U.S.A.

- 3-Parts!**
- Part 3 is the jewelry envelope.
 - Part 2 is the customer claim form.
 - Part 1 is for your records.
- C JRE-9948**
Jewelry Repair Envelope/Claim Check
4¼" x 7¼"
Imprint area 1" x 3½"
Envelope has pressure sensitive tape

YOUR COMPANY NAME
Address
CITY, STATE, ZIP CODE
Phone Number
Advertising Line

Customer's Order No. Date

Name

Address

RECEIVED	CASH	CHEQUE	CREDIT	DEBIT	REVENUE
ARTICLE	STOCK NO.	AMOUNT			

SPECIAL INSTRUCTIONS

TAX

TOTAL

DEPOSIT

BALANCE

0001001

All items and returned goods MUST be accompanied by this bill. Thank You. PRINTED IN U.S.A.

D GJ-212 - Register Form
Gift/Jewelry, 4" x 6"
Imprint area 1" x 3½"

YOUR COMPANY NAME
Address
CITY, STATE, ZIP CODE
Phone Number
Advertising Line

RECEIVED	CASH	CHEQUE	CREDIT	DEBIT	REVENUE
ARTICLE	STOCK NO.	AMOUNT			

SPECIAL INSTRUCTIONS

TAX

TOTAL

DEPOSIT

BALANCE

0001001

All items and returned goods MUST be accompanied by this bill. Thank You. PRINTED IN U.S.A.

E GJ-241 - Register Form
Gift/Jewelry, 4" x 6½"
Imprint area 1" x 3½"

NOTE:

Company Imprint
Includes your company's name, address and phone number in one of four colors! For blank forms, subtract 30%.

Multi-part Color Sequence
Colors correspond to sequence and number of parts selected in your order unless otherwise specified.

Starting Number
Choose a six-digit starting number for your imprinted form at no extra charge! Otherwise, we will start with 001001. Four, five and seven-digit numbering available at an additional charge. See page 142 for pricing.

Blank forms will be sequentially numbered unless specified otherwise.

1 Day Blank **3 Day Imprint**
Shipping

Protection

PROTECTION SYSTEM ESTIMATE SHEET

YOUR COMPANY NAME
Address
CITY, STATE, ZIP CODE
Phone Number
Advertising Line

0001001

QUANTITY	UNIT	DESCRIPTION	PRICE	AMOUNT
		Digital Communication		
		Alarm		
		Line Security		
		Smart Control		
		Control		
		Keypad H-Handset		
		Keypad W-LED		
		Keypad		
		Keypadset		
		Maglock Controls		
		Alarm Siren		
		Shock Monitor		
		Image		

WORK ORDER INVOICE

YOUR COMPANY NAME
Address
CITY, STATE, ZIP CODE
Phone Number
Advertising Line

001001

QUANTITY	UNIT	DESCRIPTION	PRICE	AMOUNT
		DUPLICATE KEYS		
		ORIGINAL KEYS		
		REABOLT (TYPE)		
		KNOBSET (TYPE)		
		LOCKSET (TYPE)		
		LABOR TO INSTALL ABOVE		
		CYLINDER COMBINATION CHANGE		
		SAFE COMBINATION CHANGE		
		EMERGENCY HOME/AUTO LOCKOUT SERVICE		
		SERVICE CALL		

WORK ORDER INVOICE

YOUR COMPANY NAME
Address
CITY, STATE, ZIP CODE
Phone Number
Advertising Line

001001

QUANTITY	UNIT	DESCRIPTION	PRICE	AMOUNT
		LABOR TO INSTALL ABOVE		
		CYLINDER COMBINATION CHANGE		
		SAFE COMBINATION CHANGE		
		EMERGENCY HOME/AUTO LOCKOUT SERVICE		
		SERVICE CALL		

WORK ORDER INVOICE

YOUR COMPANY NAME
Address
CITY, STATE, ZIP CODE
Phone Number
Advertising Line

0001001

QUANTITY	UNIT	DESCRIPTION	PRICE	AMOUNT
		LABOR TO INSTALL ABOVE		
		CYLINDER COMBINATION CHANGE		
		SAFE COMBINATION CHANGE		
		EMERGENCY HOME/AUTO LOCKOUT SERVICE		
		SERVICE CALL		

PROTECTION SYSTEM ESTIMATE SHEET

YOUR COMPANY NAME
Address
CITY, STATE, ZIP CODE
Phone Number
Advertising Line

0001001

QUANTITY	UNIT	DESCRIPTION	PRICE	AMOUNT
		Digital Communication		
		Alarm		
		Line Security		
		Smart Control		
		Control		
		Keypad H-Handset		
		Keypad W-LED		
		Keypad		
		Keypadset		
		Maglock Controls		
		Alarm Siren		
		Shock Monitor		
		Image		
		Access		
		Photoelectric Beams		
		Photo		
		Photo H-Handset		
		Photo Smart Control		
		Photo Control		
		Photo Keypad		
		Photo Keypadset		
		Photo Alarm		
		Photo Alarm Siren		
		Photo Shock Monitor		
		Photo Image		
		Photo Access Control		
		Photo Supervisors		

B
WOICC-891 - Snap-A-Part
Locksmith Work Order/Invoice
5 7/8" x 8 1/2"
Imprint area 1" x 3"

C
WOCC-850 - Snap-A-Part
Locksmith Work Order/Invoice
5 7/8" x 8 1/2"
Imprint area 1" x 3 1/4"

D
LWOCC-245 - Register Form
Locksmith Work Order/Invoice
5 1/2" x 8 1/2"
Imprint area 1" x 5"

A
PSECC-863 - Snap-A-Part
Protection System Estimate Sheet, 8 1/2" x 11"
Imprint area 3/4" x 4"
Parts 2 and 3 contain blackout.

A PSECC-863 - Protection System Estimate Sheet

Cat. No.	Pts.	Wt. per 1000	Carbonless Lot Prices				
			250	500	1000	2000	3000
863-3	3	35#	118.20	191.93	340.55	652.86	966.11

Not available numbered. (R)
Last part is manila tag.
Envelopes available on page 100. (9906)

B WOICC-891 - Locksmith Work Order/Invoice

Cat. No.	Pts.	Wt. per 1000	Carbonless Lot Prices				
			250	500	1000	2000	3000
891-2	2	9#	77.43	105.82	168.32	293.12	415.27
891-3	3	13#	85.64	123.61	205.35	364.99	531.70

Envelopes available on page 101. (9919) (R)

C WOCC-850 - Locksmith Work Order/Invoice

Cat. No.	Pts.	Wt. per 1000	Carbonless Lot Prices				
			250	500	1000	2000	3000
850-3	3	13#	89.91	129.84	215.54	383.19	558.43

Envelopes available on page 101. (9919) (R)

D LWOCC-245 - Locksmith Work Order/Invoice

Cat. No.	Pts.	Wt. per 1000	Carbonless Lot Prices				
			250	500	1000	2000	3000
245-3	3	12#	85.02	117.36	179.66	304.77	434.36

7 digit number only. (R)

E PSCC-865 - Protection System Work Order/Invoice

Cat. No.	Pts.	Wt. per 1000	Carbonless Lot Prices				
			250	500	1000	2000	3000
865-3	3	35#	118.20	191.83	340.55	652.86	966.11

Material and Layout areas on back. (R)
Last part is manila tag.
Envelopes available on page 100. (9906, 9907, 9909)

PROTECTION SYSTEM Work Order / Invoice

YOUR COMPANY NAME
Address
CITY, STATE, ZIP CODE
Phone Number
Advertising Line

001001

TO: _____

DATE: _____

DESCRIPTION OF WORK:

QUANTITY	UNIT	DESCRIPTION	PRICE	AMOUNT
		Digital Communication		
		Alarm		
		Line Security		
		Smart Control		
		Control		
		Keypad H-Handset		
		Keypad W-LED		
		Keypad		
		Keypadset		
		Maglock Controls		
		Alarm Siren		
		Shock Monitor		
		Image		
		Access		
		Photoelectric Beams		
		Photo		
		Photo H-Handset		
		Photo Smart Control		
		Photo Control		
		Photo Keypad		
		Photo Keypadset		
		Photo Alarm		
		Photo Alarm Siren		
		Photo Shock Monitor		
		Photo Image		
		Photo Access Control		
		Photo Supervisors		

E
PSCC-865 - Snap-A-Part
Protection System Work Order/Invoice, 8 1/2" x 11"
Imprint area 1 1/4" x 4"

NOTE:

Multi-part Color Sequence

1 Day Blank **3 Day Imprint**

Shipping

Colors correspond to sequence and number of parts selected in your order unless otherwise specified.



Backer

A 4651 - Snap-A-Part
Bar Guest Check, 4¼" x 6½"
Imprint area ¾" x 3½"



B 4928 - Snap-A-Part
Guest Check, 4¼" x 9"
Imprint area ¾" x 3½", Bi-Lingual

End of Part-1

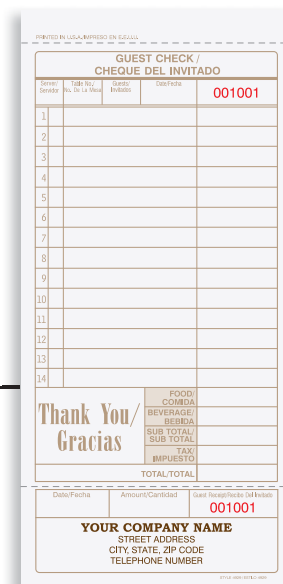

C 4929 - Snap-A-Part
Guest Check, 4¼" x 9"
Imprint area ¾" x 3½", Bi-Lingual

A 4651 - Bar Guest Check

Cat. No.	Pts.	Wt. per 2500	Imprinted Lot Prices				
			2500	5000	10000	15000	20000
4651	1	13#	226.15	409.19	821.76	1,166.62	1,521.78
			Blank Lot Prices				
4651	1	13#	104.16	190.68	367.90	545.32	718.17

All checks will be imprinted in brown ink unless otherwise specified. (R)

B 4928 - Guest Check, Bi-Lingual

Cat. No.	Pts.	Wt. per 2500	Imprinted Lot Prices				
			2500	5000	10000	15000	20000
4928	1	18#	244.04	445.38	848.90	1,262.72	1,666.96
			Blank Lot Prices				
4928	1	18#	123.71	229.79	449.85	673.76	882.39

All checks will be imprinted in brown ink unless otherwise specified. Bi-Lingual. (R)

C 4929 - Guest Check, Bi-Lingual

Cat. No.	Pts.	Wt. per 2500	Imprinted Carbonless Lot Prices				
			2500	5000	10000	15000	20000
4929	2	24#	277.32	514.64	995.96	1,484.76	1,965.24
			Blank Carbonless Lot Prices				
4929	2	24#	126.62	246.64	486.88	721.08	949.16

All checks will be imprinted in brown ink unless otherwise specified. Bi-Lingual. (R)

D 4851 - Bar Guest Check

Cat. No.	Pts.	Wt. per 2500	Imprinted Lot Prices				
			2500	5000	10000	15000	20000
4851	1	19#	244.04	445.38	848.90	1,262.72	1,666.96
			Blank Lot Prices				
4851	1	19#	123.71	229.79	449.85	673.76	882.39

All checks will be imprinted in brown ink unless otherwise specified. (R)

NOTE:



Choose a six-digit starting number for your imprinted form at no extra charge! Otherwise, we will start with 001001. Four, five and seven-digit numbering available at an additional charge. See page 142 for pricing.

Blank forms will be sequentially numbered unless specified otherwise.

Special!

We will pad your Guest Checks in sets of 50 with a firm glue binding and backer for just \$4.18(R) per 1000.

! If your guests are Bi-Lingual, the 4928 or 4929 may work best for you.

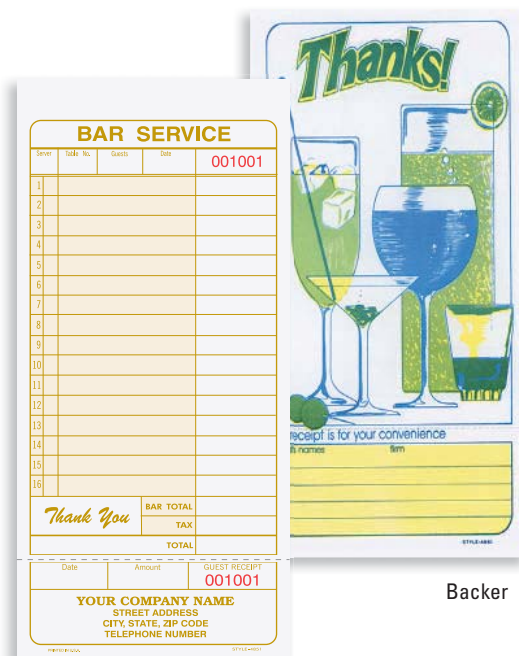

Backer

D 4851 - Snap-A-Part
Bar Guest Check, 4¼" x 9"
Imprint area ¾" x 3½"



Guest Check

SERVER: _____ TABLE NO.: _____ GUESTS: _____ DATE: 047533

1	
2	
3	
4	
5	
6	
7	
8	
9	
10	
11	
12	
13	
14	
15	

TRANSFER TO FRONT TOTAL

May you think of your visit as a pleasant one, remembering us each year returns.

What is for your convenience

FOOD	
BEVERAGE	
SUB TOTAL	
TAX	
TOTAL	

THANK YOU

GUEST RECEIPT 047533

DATE _____ AMOUNT _____

Backer

A 412 - Snap-A-Part
Guest Check, 4¼" x 9"

Beverages

1	
2	
3	

TRANSFER TO FRONT TOTAL

May you think of your visit as a pleasant one, remembering us each year returns.

What is for your convenience

FOOD	
BEVERAGE	
SUB TOTAL	
TAX	
TOTAL	

THANK YOU

GUEST RECEIPT 047533

DATE _____ AMOUNT _____

KITCHEN CHECK

DATE: _____ TIME: _____ GUESTS: _____ SERVER: 001001

APPY-SOUP-SAL-ENTREE-VEG-POT-DESSERT-BEV

GUEST CHECK™

DATE: _____ TIME: _____ GUESTS: _____ SERVER: 001001

APPY-SOUP-SAL-ENTREE-VEG-POT-DESSERT-BEV

Tax _____ Total _____

Thank You - Please Come Again

PRINTED IN U.S.A. 400

Part 2

Guest Check

TABLE NO.: _____ NO. PERSONS: _____ SERVER NO.: 001001

Tax _____ Total _____

Thank You!

C 814 - Snap-A-Part
Guest Check Pad, 3½" x 6"
100 checks per pad

B 4246 - Snap-A-Part
Guest Check, 3½" x 6"

A 412 - Guest Check

Cat. No.	Pts.	Wt. per 2000	Impact Paper Lot Prices				
			2000	4000	8000	20000	48000
412	2	22#	115.80	225.73	445.59	1,085.71	2,572.39

No choice of starting number. (R)
Not available imprinted.

B 4246 - Guest Check

Cat. No.	Pts.	Wt. per 2500	Carbonless Lot Prices				
			2500	5000	10000	15000	20000
4246	2	13#	118.30	229.79	439.87	624.99	786.08

No choice of starting number. (R)
Not available imprinted.

C 814 - Guest Check Pad

Cat. No.	Pts.	Wt. per 40 Pads	Lot Prices		
			40 Pads	200 Pads	400 Pads
814	1	8#	36.35	168.84	318.60

No choice of starting number. (R)
Not available imprinted.

D 700 - Guest Check

Cat. No.	Pts.	Wt. per 2000	Carbonless Lot Prices				
			2000	4000	8000	20000	48000
700	2	22#	149.92	270.14	489.48	1,126.06	2,615.34

No choice of starting number. (R)
Not available imprinted.

Guest Check

SERVER: _____ TABLE NO.: _____ GUESTS: _____ DATE: 8804091

1	
2	
3	
4	
5	
6	
7	
8	
9	
10	
11	
12	
13	
14	
15	

TRANSFER TO FRONT TOTAL

May you think of your visit as a pleasant one, remembering us each year returns.

What is for your convenience

FOOD	
BEVERAGE	
SUB TOTAL	
TAX	
TOTAL	

THANK YOU

GUEST RECEIPT 8804091

DATE _____ AMOUNT _____

Backer

D 700 - Snap-A-Part
Guest Check, 4¼" x 9"

NOTE:



Choose a six-digit starting number for your imprinted form at no extra charge! Otherwise, we will start with 001001. Four, five and seven-digit numbering available at an additional charge. See page 142 for pricing.

Blank forms will be sequentially numbered unless specified otherwise.

Special!

We will pad your Guest Checks in sets of 50 with a firm glue binding and backer for just \$4.18(R) per 1000.



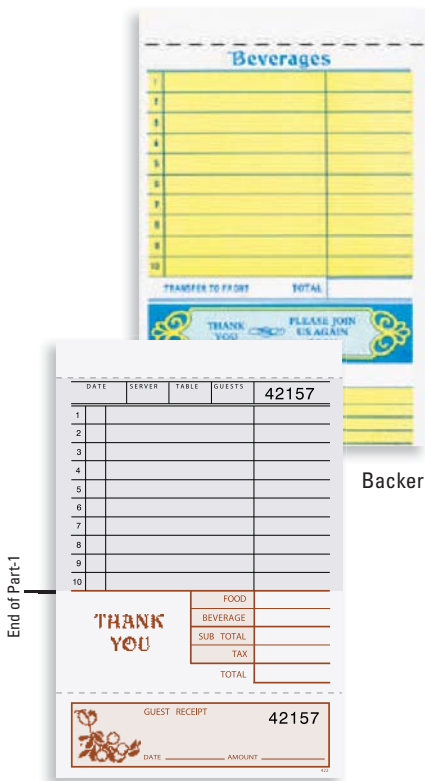

Backer

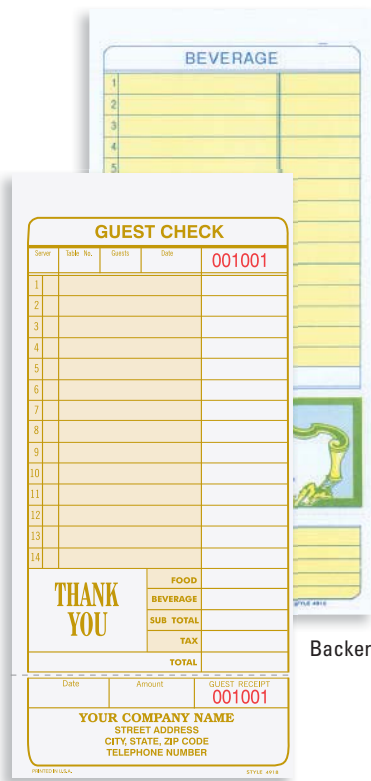

Backer

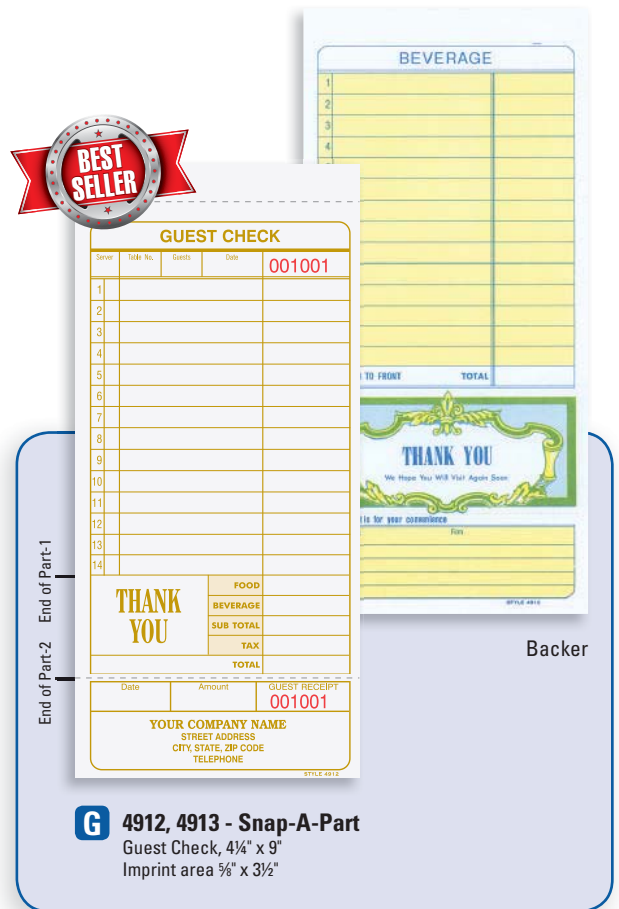

Backer

E 422 - Snap-A-Part
Guest Check, 4 1/4" x 6 1/2"

F 4918 - Snap-A-Part
Guest Check, 4 1/4" x 9"
Imprint area 3/8" x 3 1/2"

G 4912, 4913 - Snap-A-Part
Guest Check, 4 1/4" x 9"
Imprint area 5/8" x 3 1/2"

E 422 - Guest Check

Cat. No.	Pts.	Wt. per 2000	Impact Paper Lot Prices				
			2000	4000	8000	20000	
422	2	16#	114.04	193.39	347.52	792.95	1,816.10

No choice of starting number.
Not available imprinted. (R)

F 4918 - Guest Check

Cat. No.	Pts.	Wt. per 2500	Imprinted Lot Prices				
			2500	5000	10000	15000	
4918	1	18#	244.04	445.38	848.90	1,262.72	1,666.96

Blank Lot Prices

4918	1	18#	123.71	229.79	449.85	673.76	882.39
------	---	-----	--------	--------	--------	--------	--------

All checks will be imprinted in brown ink unless otherwise specified. (R)

G 4912, 4913 - Guest Check

Cat. No.	Pts.	Wt. per 2500	Imprinted Carbonless Lot Prices				
			2500	5000	10000	15000	
4912	2	24#	317.25	588.48	1,139.16	1,698.27	2,247.70
		per 2000	2000	6000	10000	16000	20000
4913	3	27#	323.18	914.94	1,486.84	2,370.11	2,945.75

Blank Carbonless Lot Prices

4912	2	24#	144.92	282.20	556.97	824.88	1,085.71
		per 2000	2000	6000	10000	16000	20000
4913	3	27#	238.11	694.15	1,142.08	1,810.80	2,242.60

All checks will be imprinted in brown ink unless otherwise specified. (R)

H 434 - Guest Check

Cat. No.	Pts.	Wt. per 2000	Carbonless Lot Prices				
			2000	4000	8000	20000	
434	2	22#	115.80	225.73	445.59	1,085.71	2,572.39

No choice of starting number.
Not available imprinted. (R)

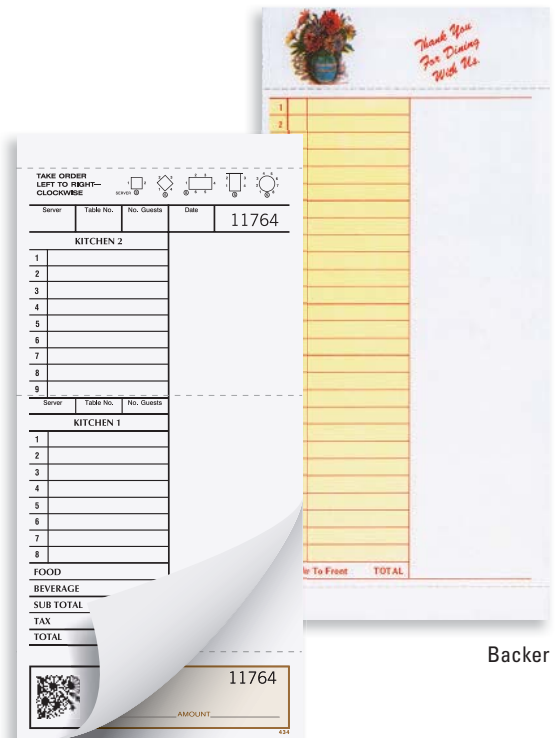

Backer

H 434 - Snap-A-Part
Guest Check, 4 1/4" x 9"



-  4901 Italian Food
-  4902 Steaks
-  4905 Mexican Food

Backer

A 4901, 4902, 4905 - Snap-A-Part
Guest Check, 4½" x 9"
Imprint area ¾" x 3½"

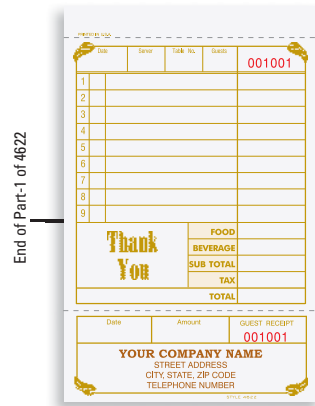

B 4611, 4622 - Snap-A-Part
Guest Check, 4¼" x 6½"
Imprint area ¾" x 3½"



C NS-247 - Snap-A-Part
Guest Check, 4¼" x 9"
Imprint area ¾" x 3½"

A 4901, 4902, 4905 - Guest Check

Cat. No.	Pts.	Wt. per 2500	Imprinted Carbonless Lot Prices				
			2500	5000	10000	15000	20000
4901	2	23#	317.25	588.48	1,139.16	1,698.27	2,247.70
4902	2	23#	317.25	588.48	1,139.16	1,698.27	2,247.70
4905	2	23#	317.25	588.48	1,139.16	1,698.27	2,247.70
Blank Carbonless Lot Prices							
4901	2	23#	144.92	282.20	556.97	824.88	1,085.71
4902	2	23#	144.92	282.20	556.97	824.88	1,085.71
4905	2	23#	144.92	282.20	556.97	824.88	1,085.71

All checks will be imprinted in brown ink unless otherwise specified. (R)

B 4611, 4622 - Guest Check

Cat. No.	Pts.	Wt. per 2500	Imprinted Carbonless Lot Prices				
			2500	5000	10000	15000	20000
4611	1	13#	226.15	409.19	790.56	1,166.62	1,521.78
4622	2	17#	289.90	533.99	1,030.38	1,530.72	2,027.12
Blank Carbonless Lot Prices							
4611	1	13#	104.16	190.68	367.90	545.32	718.17
4622	2	17#	170.61	323.60	635.28	942.29	1,242.23

All checks will be imprinted in brown ink unless otherwise specified. (R)

C NS-247 - Guest Check

Cat. No.	Pts.	Wt. per 2500	Imprinted Carbonless Lot Prices			
			5000	10000	15000	
NS-247	2	25#	317.25	588.48	1,139.16	1,698.27
Blank Carbonless Lot Prices						
NS-247	2	25#	144.92	282.20	556.97	824.88

All checks will be imprinted in brown ink unless otherwise specified. (R)

NOTE:



Choose a six-digit starting number for your imprinted form at no extra charge! Otherwise, we will start with 001001. Four, five and seven-digit numbering available at an additional charge. See page 142 for pricing.

Blank forms will be sequentially numbered unless specified otherwise.

Special!

We will pad your Guest Checks in sets of 50 with a firm glue binding and backer for just \$4.18(R) per 1000.





D 312 - Snap-A-Part
Guest Check, 4¼" x 9"

E 204 - Snap-A-Part
Guest Check, 4¼" x 9"

F BR-598 - Snap-A-Part
Guest Check, 5" x 9½"
Imprint area ¾" x 3½"

D 312 - Guest Check

Cat. No.	Pts.	Wt. per 2000	Impact Paper Lot Prices			
			2000	4000	8000	20000
312	2	22#	115.80	225.73	445.59	1,085.71
						2,572.39

No choice of starting number.
Not available imprinted. (R)

E 204 - Guest Check

Cat. No.	Pts.	Wt. per 2000	Carbonless Lot Prices			
			2000	4000	8000	20000
204	3	22#	197.55	366.24	696.02	1,680.17
						3,947.06

No choice of starting number.
Not available imprinted. (R)

F BR-598 - Guest Check

Cat. No.	Pts.	Wt. per 2500	Imprinted Impact Paper Lot Prices			
			2500	5000	10000	20000
598-1	1	21#	243.31	437.16	804.08	1,172.65
598-2	2	28#	340.25	658.45	1,282.15	1,774.15
						2,306.35
Blank Impact Paper Lot Prices						
598-1	1	21#	141.81	254.12	490.93	710.58
598-2	2	28#	241.54	463.16	913.59	1,351.12
						1,775.75

All checks will be imprinted in brown ink unless otherwise specified. (R)

G 202 - Guest Check

Cat. No.	Pts.	Wt. per 2000	Lot Prices			
			2000	4000	8000	20000
202	1	12#	91.68	158.65	266.08	581.31
						1,313.26

No choice of starting number.
Not available imprinted. (R)



G 202 - Snap-A-Part
Guest Check, 4¼" x 8½"

GUEST REGISTRATION

NAME _____ ROOM NO. _____
 STREET _____ CHECKOUT DATE _____
 CITY _____ STATE AND ZIP _____ ARRIVAL DATE / TIME _____
 (AREA CODE) PHONE NO. _____ COMPANY REPRESENTING _____ ROOM RATE / TAX _____
 CAR LICENSE _____ STATE _____ MAKE AND COLOR _____ YEAR _____ RECEIVED BY _____
 NO. IN PARTY _____ SIGNATURE _____
 X
 PAYMENT WILL BE MADE BY: CREDIT CARD CASH CHECK
 CREDIT CARD USED: _____
 CARD NO. _____

DAYS OCCUPIED	ROOM TOTAL
SUN	TAX
MON	
TUE	
WED	TOTAL
THURS	AMT. PAID
FRI	AMT. DUE
SAT	

NOTICE TO GUESTS
 This property is privately owned, and management reserves the right to refuse service to anyone. We will not be responsible for accidents or injury to guests or for loss of money, jewelry or valuables of any kind.

CHECK-OUT TIME: 11 AM
YOUR COMPANY NAME
 Address
 CITY, STATE, ZIP CODE
 Phone Number

001001

GRCC-694-2
 Printed in U.S.A.

- A GRCC-694 - Snap-A-Part**
 Hotel Guest Registration Form, 5 1/4" x 4 1/4"
 Imprint area 1" x 4"
 Imprint includes your 'check out' time choice.

HOOK OVER MIRROR ON CAR DASH

01001

01001

LOCATION _____
 LICENSE NO. _____ MAKE OF CAR _____

SPECIAL NOTES:

VALET COPY

YOUR COMPANY NAME
 Address
 CITY, STATE, ZIP CODE
 Phone Number
 Advertising Line

NO CAR RELEASED WITHOUT THIS CLAIM CHECK 01001
 No responsibility for auto accessories or articles left in car is assumed. No liability is assumed for fire, theft or damage while in the custody of the valet service.
 Thank You! Please Come Again.
 GUEST RECEIPT

- B VC-800 - Valet Parking Tag**
 3 1/8" x 7"
 Imprint area 3/4" x 2 3/4"



- C 4805 - Key Card Holder**
 One Curved Pocket, 2 3/4" x 4 1/2" (closed)
 Imprint area 2 1/4" x 1"

Card Holder, Inside Layout

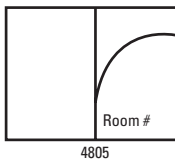

A GRCC-694 - Hotel Guest Registration Form

Cat. No.	Wt.	Carbonless Lot Prices					
GRCC- Pts.	per 1000	250	500	1000	2000	3000	
694-2	2	6#	60.37	100.52	167.60	301.65	427.49

Last part is white tag. (R)

B VC-800 - Valet Parking Tag

Cat. No.	Wt.	Blank Lot Prices					
VC- Pts.	per 10 Pkgs	1 Pkgs	2 Pkgs	5 Pkgs	10 Pkgs	20 Pkgs	
800-1	1	5#	41.55	47.37	84.60	120.80	235.82
Imprinted Lot Prices							
800-1	1	5#	66.61	67.65	113.52	157.82	301.03

No choice of starting number.
 100 per package. (R)

C 4805 - Key Card Holder - One Curved Pocket

Cat. No.	Wt.	Blank Lot Prices				
	per 1000	100	250	500	1000	2500
4805	12#	62.24	103.74	172.80	288.24	648.28
Imprinted Lot Prices						
4805	12#	84.60	133.38	210.13	332.54	742.30

Not available numbered. (R)

NOTE:



Includes your company's name, address and phone number in one of four colors! For blank forms, subtract 30%.



Colors correspond to sequence and number of parts selected in your order unless otherwise specified.



Choose a six-digit starting number for your imprinted form at no extra charge! Otherwise, we will start with 001001. Four, five and seven-digit numbering available at an additional charge. See page 142 for pricing.

Blank forms will be sequentially numbered unless specified otherwise.

VIDEO/DVD RENTAL AGREEMENT

YOUR COMPANY NAME

Address
CITY, STATE, ZIP CODE
Phone Number
Advertising Line

REVISÉ

DATE OUT A.M. P.M. TOTAL TIME DUE BACK A.M. P.M.

NAME MEMBERSHIP #

STREET

CITY, STATE, ZIP PHONE

STOCK #	TITLES	AMOUNT

DEPOSIT CLERK'S INITIALS TAX

FORMAT DVD BLU-RAY VIDEO GAME MACHINE

I, the undersigned, do accept the above listed video(s), DVD(s) or video games for the purpose of viewing them in my home. I may not loan the video(s), DVD(s) or video games to anyone else for any reason whatsoever. I acknowledge that they are in good working condition and I agree to pay a charge (equal to full cash value or reasonable cost of repairing or daily rate for days late) in the event of any items lost, damaged or returned late. I also acknowledge this company from all claims or liabilities to all parties, damage or loss of property arising out of or during use of these video(s), DVD(s) or video games. I understand that Federal Law prohibits the reproduction of all copyrighted video(s)/DVD(s)/video games.

CUSTOMER'S SIGNATURE X
0001001 PRINTED IN U.S.A.

PRINTED IN U.S.A.

VIDEO/DVD RENTAL AGREEMENT

YOUR COMPANY NAME

Address
CITY, STATE, ZIP CODE
Phone Number
Advertising Line

REVISÉ

DATE OUT A.M. P.M. TOTAL TIME DUE BACK A.M. P.M.

NAME MEMBERSHIP #

STREET

CITY, STATE, ZIP PHONE

STOCK #	TITLES	AMOUNT

DEPOSIT CLERK'S INITIALS TAX

FORMAT DVD BLU-RAY VIDEO GAME MACHINE

I, the undersigned, do accept the above listed video(s), DVD(s) or video games for the purpose of viewing them in my home. I may not loan the video(s), DVD(s) or video games to anyone else for any reason whatsoever. I acknowledge that they are in good working condition and I agree to pay a charge (equal to full cash value or reasonable cost of repairing or daily rate for days late) in the event of any items lost, damaged or returned late. I also acknowledge this company from all claims or liabilities to all parties, damage or loss of property arising out of or during use of these video(s), DVD(s) or video games. I understand that Federal Law prohibits the reproduction of all copyrighted video(s)/DVD(s)/video games.

CUSTOMER'S SIGNATURE X
No. 001001 PRINTED IN U.S.A.

YOUR COMPANY NAME

Address
CITY, STATE, ZIP CODE
Phone Number
Advertising Line

REVISÉ

DATE OUT A.M. P.M. TOTAL TIME DUE BACK A.M. P.M.

NAME MEMBERSHIP #

STREET

CITY, STATE, ZIP PHONE

STOCK #	TITLES	AMOUNT

DEPOSIT CLERK'S INITIALS TAX

FORMAT DVD BLU-RAY VIDEO GAME MACHINE

I, the undersigned, do accept the above listed video(s), DVD(s) or video games for the purpose of viewing them in my home. I may not loan the video(s), DVD(s) or video games to anyone else for any reason whatsoever. I acknowledge that they are in good working condition and I agree to pay a charge (equal to full cash value or reasonable cost of repairing or daily rate for days late) in the event of any items lost, damaged or returned late. I also acknowledge this company from all claims or liabilities to all parties, damage or loss of property arising out of or during use of these video(s), DVD(s) or video games. I understand that Federal Law prohibits the reproduction of all copyrighted video(s)/DVD(s)/video games.

CUSTOMER'S SIGNATURE X
0001001 PRINTED IN U.S.A.

A VRACC-580 - Snap-A-Part
Video/DVD Rental, 4 1/4" x 7"
Imprint area 1" x 3 3/8"

B VRA-200 - Register Form
Video/DVD Rental, 5 1/2" x 8 1/2"
Imprint area 1" x 5"

C VRA-231 - Register Form
Video/DVD Rental, 4" x 6 1/2"
Imprint area 1" x 3 1/2"

A VRACC-580 - Video/DVD Rental

Cat. No.	Pts.	Wt. per 1000	Carbonless Lot Prices				
			250	500	1000	2000	3000
VRACC-580-2	2	6#	71.19	92.09	140.76	238.21	332.54
VRACC-580-3	3	9#	78.88	108.42	173.32	302.80	433.94

(R)

B VRA-200 - Video/DVD Rental

Cat. No.	Pts.	Wt. per 1000	Carbonless Lot Prices				
			250	500	1000	2000	3000
VRA-200-2	2	8#	74.62	97.50	140.56	228.54	315.07

7 digit number only. (R)

C VRA-231 - Video/DVD Rental

Cat. No.	Pts.	Wt. per 1000	Carbonless Lot Prices				
			250	500	1000	2000	3000
VRA-231-2	2	5#	71.60	92.61	125.58	192.98	259.42

7 digit number only. (R)

D RACC-582, RA-581 - Rental Agreement

Cat. No.	Pts.	Wt. per 1000	Carbonless Lot Prices				
			250	500	1000	2000	3000
RACC-582-3	3	13#	89.91	129.84	215.54	383.16	558.43
Carbon Lot Prices							
RA-581-3	3	16#	81.17	113.00	181.64	318.30	458.28

(R)

NOTE:



YOUR COMPANY NAME 001001

Address
CITY, STATE, ZIP CODE
Phone Number
Advertising Line

NAME	DATE AND TIME OUT
ADDRESS	DATE AND TIME IN
DRIVER'S LICENSE #	REGISTRATION #
PHONE	TOTAL TIME
ADDRESS WHERE ITEM IS TO BE USED	DUE BACK
CREDIT CARD TYPE / #	EXP. DATE

ITEM RENTED	PERIOD OF TIME	RATE	AMOUNT

MERCHANDISE SOLD	QTY. OUT	QTY. USED	@	AMOUNT

TOTAL RENT
TOTAL MERCHANDISE
TAX
TOTAL CHARGES
LESS DEPOSIT
TOTAL DUE
REFUND

CUSTOMER'S SIGNATURE

0001001
PRINTED IN U.S.A. **RENTAL AGREEMENT**

D RACC-582, RA-581 - Snap-A-Part
Rental Agreement, 5 1/2" x 8 1/2"
Imprint area 1" x 5"

Pharmacy & Veterinary

A PH-211 - Register Form
Pharmacy, 4" x 6"
Imprint area 1" x 3½"

B PH-233 - Register Form
Pharmacy, 4" x 6½"
Imprint area 1" x 3½"

C PHCC-853 - Snap-A-Part
Pharmacy, 4¼" x 7"
Imprint area 1" x 3¾"

D VT-245 - Register Form
Veterinary, 4" x 6½"
Imprint area 1" x 3½"

E VT-246 - Register Form
Veterinary, 5½" x 8½"
Imprint area 1" x 5"

F VTCC-845 - Snap-A-Part
Veterinary, 4¼" x 7"
Imprint area 1" x 3¾"

A PH-211 - Pharmacy

Cat. No.	PH-	Pts.	Wt. per 1000	Carbonless Lot Prices				
				250	500	1000	2000	3000
211-2		2	5#	67.03	82.00	111.12	170.92	230.41
211-3		3	6#	73.79	95.32	135.77	219.08	302.48

(R)

B PH-233 - Pharmacy

Cat. No.	PH-	Pts.	Wt. per 1000	Carbonless Lot Prices				
				250	500	1000	2000	3000
233-2		2	5#	71.60	92.61	125.58	192.98	259.42
233-3		3	6#	81.17	104.78	149.29	240.60	332.54

(R)

C PHCC-853 - Pharmacy

Cat. No.	PHCC-	Pts.	Wt. per 1000	Carbonless Lot Prices				
				250	500	1000	2000	3000
853-2		2	6#	71.19	92.09	140.76	238.21	332.54

(R)

D VT-245 - Veterinary

Cat. No.	VT-	Pts.	Wt. per 1000	Carbonless Lot Prices				
				250	500	1000	2000	3000
245-2		2	5#	71.60	92.61	125.58	192.98	259.42

(R)

E VT-246 - Veterinary

Cat. No.	VT-	Pts.	Wt. per 1000	Carbonless Lot Prices				
				250	500	1000	2000	3000
246-2		2	8#	76.81	100.31	144.72	235.20	324.32

(R)

F VTCC-845 - Veterinary

Cat. No.	VTCC-	Pts.	Wt. per 1000	Carbonless Lot Prices				
				250	500	1000	2000	3000
845-2		2	6#	71.19	92.09	140.76	238.21	332.54

(R)



A PDE-9949
Pill/Drug Envelope, 2¼" x 3½"
Gummed flap
24# White

A PDE-9949 - Pill/Drug Envelope

Cat. No.	Wt.	Blank Lot Prices			
PDE-	per 1000	250	500	1000	2000
9949	4#	54.03	86.06	122.98	233.64

Not available imprinted. (R)

B COPA-185 - Co-Pay Medical Receipt Book

Cat. No.	Pts.	Wt.	Carbonless Imprinted Lot Prices				
COPA-		per 5 Bks	5 Bks	10 Bks	15 Bks	25 Bks	50 Bks
185-2	2	4#	125.06	182.16	230.83	327.13	577.15
Carbonless Blank Lot Prices							
185-2	2	4#	87.62	127.66	161.56	229.27	404.09

(R)

C MRB-109 - Medical Receipt Book

Cat. No.	Pts.	Wt.	Carbonless Imprinted Lot Prices				
MRB-		per 5 Bks	5 Bks	10 Bks	15 Bks	25 Bks	50 Bks
109-3	3	6#	209.59	338.81	470.49	688.01	1,315.03

(R)

NOTE:



Includes your company's name, address and phone number in one of four colors! For blank forms, subtract 30%.



Choose a six-digit starting number for your imprinted form at no extra charge! Otherwise, we will start with 001001. Four, five and seven-digit numbering available at an additional charge. See page 142 for pricing.

Blank forms will be sequentially numbered unless specified otherwise.



Colors correspond to sequence and number of parts selected in your order unless otherwise specified.



B COPA-185 - Wire Bound Book
Co-Pay Medical Receipt Book, 6½" x 11" overall
Receipt size 5½" x 2¾"
Imprint area ¾" x 1¾"
200 receipts per book

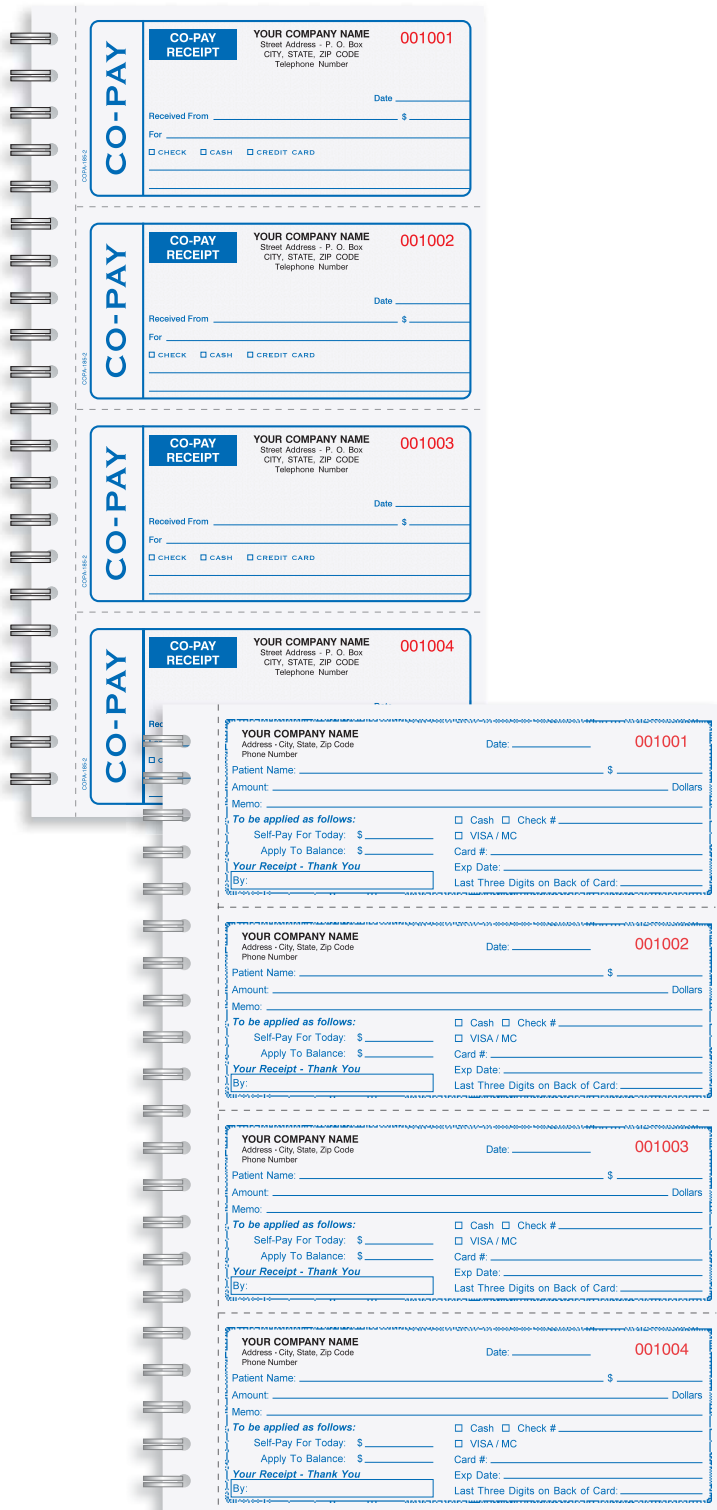

C MRB-109 - Wire Bound Book
Medical Receipt Book, 7½" x 11" overall
Receipt size 6¾" x 2¾"
Imprint area ⅞" x 2½"
200 receipts per book

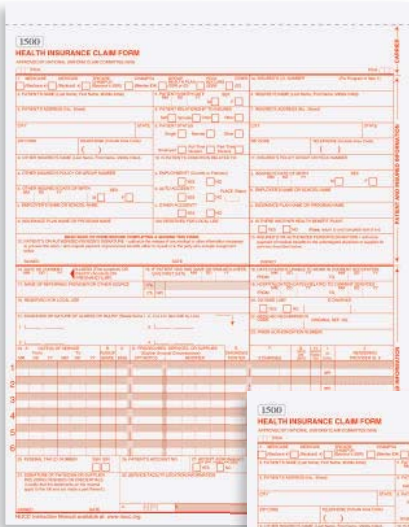

A MCF-387-2
Snap-A-Part
CMS-1500 Claim Form
8½" x 11"

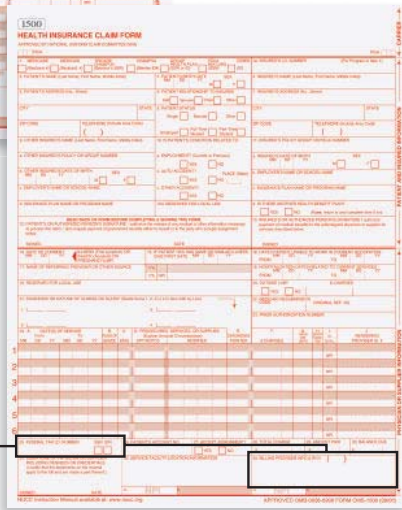

Imprint area

B MCF-387-1 - Laser
CMS-1500 Claim Form, 8½" x 11"

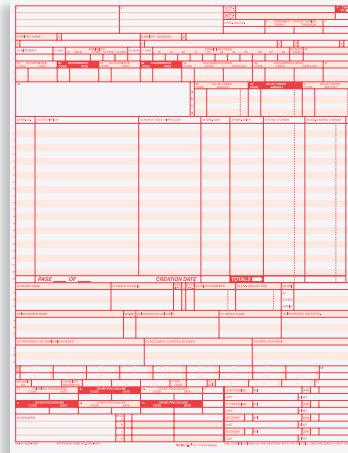

C MCF-389-1 - Laser
UB-04, CMS-1450 Claim Form, 8½" x 11"

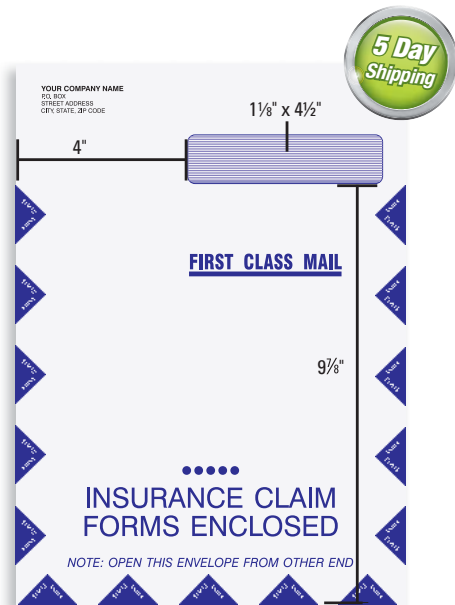

D ENV-9961
Large Claim Form Envelope, 9" x 12½"
Imprint area 1" x 4"

A MCF-387-2 - CMS-1500 Claim Form - Snap-A-Part

Cat. No.	MCF-	Pts.	Wt. per 1000	Carbonless Imprinted Lot Prices			
				250	500	1000	2000
387-2	2	18#	70.56	93.55	115.39	219.91	273.57
Blank Lot Prices							
387-2	2	18#	47.16	67.34	82.52	162.19	202.12

Not available numbered. (R)
Envelopes available on page 39.

B MCF-387-1 - CMS-1500 Claim Form - Laser

Cat. No.	MCF-	Pts.	Wt. per 1000	Imprinted Lot Prices			
				250	500	1000	2000
387-1	1	12#	43.63	54.96	67.03	121.63	149.85
Blank Lot Prices							
387-1	1	12#	20.23	28.96	33.96	63.91	78.26

Not available numbered. (R)
Envelopes available on page 39.

C MCF-389 - UB-04, CMS-1450 Claim Form

Cat. No.	MCF-	Pts.	Wt. per 1000	Blank Lot Prices			
				250	500	1000	2000
389-1	1	12#	18.98	27.30	31.98	60.27	73.79

Not available imprinted or numbered. (R)
Envelopes available on page 39.

D ENV-9961 - Large Claim Form Envelope

Cat. No.	ENV-	Wt. per 500	Imprinted Lot Prices			
			100	200	500	1000
9961		12#	57.67	87.72	166.97	275.55
Blank Lot Prices						
9961		12#	32.19	61.62	143.26	263.48

(R)

NOTE:



Includes your company's name, address and phone number in one of four colors! For blank forms, subtract 30%.



Colors correspond to sequence and number of parts selected in your order unless otherwise specified.



Secure Prescription Pads

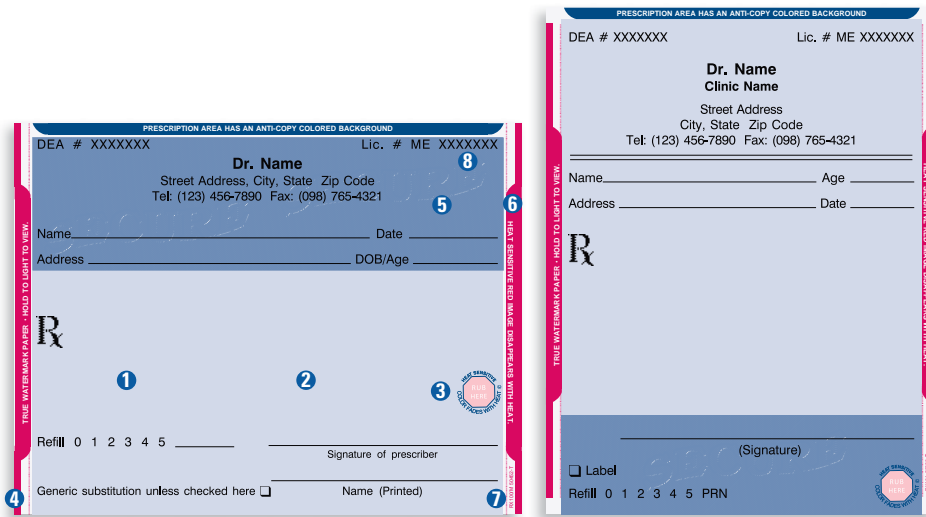

E PP-2600, 2602
Secure Prescription Form Pad
5½" x 4¼" Horizontal
Imprint area 3¾" x 5"
1 pt-100 per pad
2 pt-50 per pad

F PP-2601, 2603
Secure Prescription Form Pad
4¼" x 5½" Vertical
Imprint area 5" x 3¾"
1 pt-100 per pad
2 pt-50 per pad

Security Features on all Prescription Pads:

- 1 True watermark paper with visible and invisible fibers, chemically reactive ink and bleach reactivity
- 2 Colored Background with Anti-Copy "VOID" Protection
- 3 Heat Sensitive Thermochromic Image
- 4 Micro Printing
- 5 Raster Relief Image
- 6 Warning Bands
- 7 Lot Control Number
- 8 Sequentially Numbered for Internal Record Keeping

Do you know the latest prescription pad legislation?

1. Prevent erasure or modification of prescription information.
2. Prevent the use of counterfeit prescription forms.
3. Prevent unauthorized copying of a completed or blank form.

These pads cover all three of these requirements!

Our prescription products are compliant with the latest new requirements for use of tamper resistant prescription pads under the Medicaid program, Section 1903b(i) of the Social Security Act (42USC193b(i), paragraph (23).

Compliant in all states except California, Connecticut, Kentucky, New Jersey, New York and Wyoming.



Now available in 2-part!

E PP-2600, 2601 - One Part Prescription Form Pad

Cat. No.	PP-	Pts.	H/V	Wt. per 8	Price Per Pad									
					4	8	12	16	20	40	80	120	160	200
2600-1	1	Horz	3#	14.60	9.00	7.20	6.25	6.00	5.25	5.15	5.05	4.95	4.70	
2601-1	1	Vert	3#	14.60	9.00	7.20	6.25	6.00	5.25	5.15	5.05	4.95	4.70	

Numbered by request only.

(R)

F PP-2602, 2603 - Two Part Prescription Form Pad

Cat. No.	PP-	Pts.	H/V	Wt. per 8	Price Per Pad									
					8	16	24	32	40	80	120	180	240	300
2602-2	2	Horz	3#	11.70	8.15	7.80	7.50	6.80	6.55	6.30	6.25	6.20	6.10	
2603-2	2	Vert	3#	11.70	8.15	7.80	7.50	6.80	6.55	6.30	6.25	6.20	6.10	

Numbered by request only.

(R)

G ENV-9960 - Small Claim Form Envelope

Cat. No.	ENV-	Wt. per 500	Imprinted Lot Prices				
			500	1000	2000	3000	5000
9960		8#	99.06	117.05	226.77	300.82	457.44

(R)

H ENV-9968 - Small Claim Form Envelope

Cat. No.	ENV-	Wt. per 500	Imprinted Lot Prices				
			500	1000	2000	3000	5000
9968		8#	109.88	142.53	272.64	400.87	645.06

Blank Lot Prices

9968		8#	90.32	108.94	216.27	324.33	516.31
------	--	----	-------	--------	--------	--------	--------

(R)

I ENV-9969 - Small Claim Form Envelope

Cat. No.	ENV-	Wt. per 500	Imprinted Lot Prices				
			500	1000	2000	3000	5000
9969		8#	96.46	128.28	247.78	361.24	569.35

Blank Lot Prices

9969		8#	78.05	101.45	192.97	280.96	441.74
------	--	----	-------	--------	--------	--------	--------

(R)

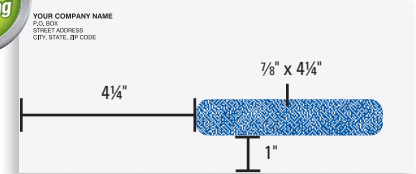

G ENV-9960
Small Claim Form Envelope, 4¼" x 9½"
Imprint area 1¾" x 4¾"

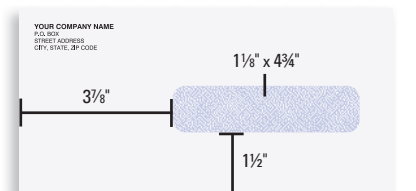

H ENV-9968
Small Claim Form Envelope, 4½" x 9½"
Imprint area 1¾" x 4¾"

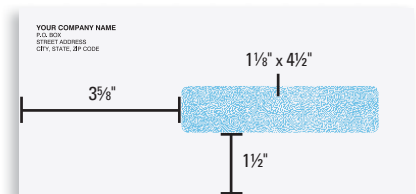

I ENV-9969
Small Claim Form Envelope, 4½" x 9"
Imprint area 1" x 5"

Application for Employment

YOUR COMPANY NAME
Address
CITY, STATE, ZIP CODE
Phone Number

PLEASE PRINT

"This position being applied for must be specified. This application is valid for only 90 days. At the time it is received, it will be reviewed for the position for which it was submitted. It will be re-considered if any required information is not included in your original application. If you are currently employed, you must include the name of your present employer, title, and dates of employment. If you have been employed by a company, you must include the name of your previous employer, title, and dates of employment. If you have been employed by a company, you must include the name of your previous employer, title, and dates of employment. If you have been employed by a company, you must include the name of your previous employer, title, and dates of employment."

Position Applied For _____ Date of Birth _____
 Referral Source Advertisement Employee Referral Current
 Public Private Employment Agency Other _____
 Name of Source (if Applicable) _____
 Name _____
 Address _____
 Telephone Number _____ Social Security Number _____
 If necessary, best time to call you is _____
 Are you 18 years of age or older? _____
 Have you ever been employed here before? From _____ To _____
 If yes, give dates _____
 Are you legally eligible for employment in the United States? _____
 (Special U.S. Consulate/Immigration status will be required before employment)
 Date available for work _____
 Type of employment desired Full Time Part Time Temporary
 Are you on lay-off and subject to recall? YES NO Will you travel if job requires it? _____
 Will you relocate if job requires it? _____ Will you travel if job requires it? _____
 Are you able to meet the attendance requirements of the position? _____
 Will you work overtime if required? _____
 Have you been convicted of a felony including theft or assault in the last seven (7) years? (Each conviction may be relevant if job-related, but does not bar you from employment.)
 If YES, please explain _____
 Driver's license number (if required by job) _____
 AN EQUAL OPPORTUNITY EMPLOYER

Employment History

List your last four (4) employers, assignments or volunteer activities, starting with the most recent, including military experience. Exclude any gaps in employment in comments section below.

Employer	Employment Dates	Start/End	Termination Reason
Address (Include Country)			
Job Title	From _____ To _____		
Immediate Supervisor and Title			
Reason for Leaving			
May no contact for reference? <input type="checkbox"/> Yes <input type="checkbox"/> No <input type="checkbox"/> Later			
Employer Telephone	From _____ To _____		
Address (Include Country)			
Job Title	From _____ To _____		
Immediate Supervisor and Title			
Reason for Leaving			
May no contact for reference? <input type="checkbox"/> Yes <input type="checkbox"/> No <input type="checkbox"/> Later			
Employer Telephone	From _____ To _____		
Address (Include Country)			
Job Title	From _____ To _____		
Immediate Supervisor and Title			
Reason for Leaving			
May no contact for reference? <input type="checkbox"/> Yes <input type="checkbox"/> No <input type="checkbox"/> Later			
Employer Telephone	From _____ To _____		
Address (Include Country)			
Job Title	From _____ To _____		
Immediate Supervisor and Title			
Reason for Leaving			
May no contact for reference? <input type="checkbox"/> Yes <input type="checkbox"/> No <input type="checkbox"/> Later			
Employer Telephone	From _____ To _____		

Comments (including explanation of any gaps in employment): _____
Skills and Qualifications Summarize special skills and qualifications acquired from employment or other experiences that may qualify you to work with our company.

Educational Background

List three schools attended, starting with the one B. List number of years completed. (C. Grade Point Average or Class Rank and E. Major and minor field of study (if applicable).)

A. School	B. No. Years Completed	C. Degree Diploma

List special accomplishments, publications, awards. (Exclude information which you feel is confidential, if any.)
 List additional information you would like us to consider: _____

Applications are considered for all positions applied for, and employees are invited during employment, without regard to race, color, religion, sex, national origin, age, disability or any other prohibited basis of discrimination, or provided under applicable law and federal law. Please feel free to let us know if you need an accommodation to complete this application process.

These answers are true and complete to the best of my knowledge. The Company may investigate all statements contained in this application and I understand that any false or misleading information provided during the application or interview process will result in withdrawal from consideration for employment or my immediate discharge. If my level, category or other experience I have is not immediately ready, the Company may apply a penalty, including suspension or termination, if I have. If any job duties or other information on this application or interview is false or misleading, I understand that the Company has the right to terminate my employment at any time without notice.

I understand that this application is not a contract of employment. I also understand that if hired, regardless of any oral representations in the interview, the employment relationship between myself and the Company is at-will and either party may terminate the employment at any time without notice.

I also understand that any offer of employment may be conditioned upon a health evaluation or a physical examination conducted by the Company. I understand that any offer of employment may be withdrawn if I do not provide a satisfactory health evaluation or physical examination within the time frame specified by the Company. I understand that any offer of employment may be withdrawn if I do not provide a satisfactory health evaluation or physical examination within the time frame specified by the Company. I understand that any offer of employment may be withdrawn if I do not provide a satisfactory health evaluation or physical examination within the time frame specified by the Company.

Signature of Applicant _____ Date _____
 (PLEASE WRITE BELOW THIS LINE)
 Interviewed By _____ Date _____
 Conducted By _____ Date _____
 Interviewed By _____ Date _____
 Conducted By _____ Date _____
 Starting Date _____ Starting Salary _____
 Department _____ Position _____
 Supervisor's Signature _____

A HR-370
Application For Employment, 8 1/2" x 11"
Imprint area 1" x 3 1/2"

A HR-370 - Application For Employment

Cat. No.	Pts.	Wt. per 1000	Imprinted Bond Lot Prices			
			25	50	100	150 200
HR-370-2	2	20#	43.00	51.95	78.57	114.04 146.90
Blank Lot Prices						
HR-370-2	2	20#	27.92	39.36	67.24	98.64 126.62

Packaged in quantities of 25. Edge glued along 11" side. (R)
 Not available numbered.

B DTJ-430, DTJ-431 - Snap-A-Part, Daily Time/Job Ticket

Cat. No.	Pts.	Wt. per 1000	Type	Carbon Lot Prices		
				1000	5000	10000
DTJ-430-3	3	22#	Crack/Peel	197.55	965.90	1,919.89
DTJ-431-3	3	17#	Gummed	159.38	758.52	1,430.57

Not available imprinted. (R)

C TC-5031 - Time Card

Cat. No.	Pts.	Wt. per 1000	Stock Lot Prices			
			500	1000	2000	3000
TC-5031	1	6#	47.37	67.65	119.03	169.78

Not available imprinted. (R)

NOTE:

Company Imprint

Includes your company's name, address and phone number in one of four colors! For blank forms, subtract 30%.

Multi-part Color Sequence

Colors correspond to sequence and number of parts selected in your order unless otherwise specified.

Starting Number

Choose a six-digit starting number for your imprinted form at no extra charge! Otherwise, we will start with 001001. Four, five and seven-digit numbering available at an additional charge. See page 142 for pricing.

Blank forms will be sequentially numbered unless specified otherwise.

1 Day Blank

3 Day Imprint

Shipping



DAILY TIME AND JOB TICKET

EMPLOYEE'S NAME		JOB TICKETS		NO.	DATE
EMP. NO.	FLAT PASTE	EMP. NO.	FLAT PASTE	EMP. NO.	DATE

BROUGHT FORWARD
TOTAL PAY

TIME CARD

NAME	CLOCK NO.	DATE	MON	TUE	WED	THUR	FRI	SAT	SUN	FIRST WEEK

TOTAL 1st WK
TOTAL 2nd WK
GRAND TOTAL

B DTJ-430 (Crack & Peel)
DTJ-431 (Gummed)
Snap-A-Part
Daily Time/Job Ticket, 4 1/4" x 11"

C TC-5031
Time Card, 3 3/8" x 8 1/2"

Backer

The image shows two attendance calendar forms, one for 2016 and one for 2015. Each form includes a header section for company information and employee details, followed by a grid for tracking attendance by month (January through December). A legend on the right side of each calendar lists various attendance codes and their meanings, such as '1. Sick Leave', '2. Vacation', '3. Personal Leave', etc.

Corrective Action Warning Notice

YOUR COMPANY NAME
Address
CITY, STATE, ZIP CODE
Phone Number

Name: _____ Date: _____
Location / Dept.: _____ Clock Number: _____

Type of Warning: Verbal (written record) Written Suspension Termination

Warning For: Safety Attendance Performance Work Rules

Statement of Fact: _____

Action Required for Correction: _____

Failure to make the necessary corrections as stated above can result in disciplinary action up to and including immediate termination from employment. I understand that in instances of gross misconduct disciplinary steps may be skipped over.

Signature on this form is only an acknowledgment of discussion and not admission of improper conduct. I understand that I have the right to disagree with the facts as stated. If I feel that the facts are in error I have the right to file a written complaint.

Employee: _____ Date: _____
Supervisor / Manager: _____ Date: _____

Distribution List: (White) Original: _____ Employee Personnel File _____
(Yellow) Copy: _____ Employee _____

E HRCC-365 - Snap-A-Part
Corrective Action Warning Notice
8½" x 11"
Imprint area 1¼" x 6"

YOUR COMPANY NAME
Address
CITY, STATE, ZIP CODE
Phone Number
Advertising Line

Employee Name/Number: _____ Date: _____

Supervisor Signature: _____ Date: _____
Employee Signature: _____ Date: _____

EMPLOYEE'S COPY

CORRECTIVE DISCIPLINE COUNSELING SYSTEM
Reference to Personal File/Regulation: _____ Date of Incident: _____

SUMMARY: _____
RESPONSE: _____

EMPLOYEE'S COPY

WRITTEN WARNING RECORD
Reference to Personal File/Regulation: _____ Date of Incident: _____

SUMMARY: _____
RESPONSE: _____

EMPLOYEE'S COPY

SECOND WRITTEN WARNING or WORK SUSPENSION NOTICE
Reference to Personal File/Regulation: _____ Date of Incident: _____

SUMMARY: _____
RESPONSE: _____

EMPLOYEE'S COPY

EMPLOYEE TERMINATION RECORD
Reference to Personal File/Regulation: _____ Date of Incident: _____

SUMMARY: _____
RESPONSE: _____

EMPLOYEE'S COPY

DATE PRINTED: OFFICE FILE

F CDCC-374 - Snap-A-Part
Corrective Discipline Form, 8½" x 11"
Imprint area ¾" x 2½"

The Corrective Discipline Form is a progressive discipline form. It helps to improve employee behavior/performance and also helps to protect against wrongful discharge claims.

D AC-370
Attendance Calendar, 8½" x 11"
Imprint area ¾" x 4"

D AC-370 - Attendance Calendar

Cat. No.	Pts.	Wt. per Pkg	Imprinted Lot Prices			
			1 Pkgs	2 Pkgs	5 Pkgs	10 Pkgs
370-1	1	1#	55.69	101.45	224.90	360.93
Blank Lot Prices						
370-1	1	1#	43.00	75.87	161.50	265.88

Packaged in quantities of 50. (R)
Not available numbered.
2016 available upon request.

E HRCC-365 - Corrective Action Warning Notice

Cat. No.	Pts.	Wt. per 1000	Carbonless Lot Prices				
			250	500	1000	2000	3000
365-2	2	16#	82.21	120.17	202.85	366.34	530.35

Numbered by request only. (R)

F CDCC-374 - Corrective Discipline Form

Cat. No.	Pts.	Wt. per Pkg	Imprinted Carbonless Lot Prices				
			1 Pkg	2 Pkgs	5 Pkgs	10 Pkgs	20 Pkgs
374-5	5	1#	92.92	153.56	336.60	592.54	1,023.41
Blank Lot Prices							
374-5	5	1#	76.70	129.22	289.48	525.15	942.71

Packaged in quantities of 50. (R)
Not available numbered.

G TERCC-363 - Travel Expense Report

Cat. No.	Pts.	Wt. per 1000	Carbonless Lot Prices				
			250	500	1000	2000	3000
363-2	2	16#	57.46	83.98	142.01	256.52	371.33

Not available imprinted or numbered. (R)

TRAVEL EXPENSE REPORT ATTACH RECEIPTS FOR LODGING AND FOR EACH ITEM OVER \$25

DATE: _____

DATE	SUNDAY	MONDAY	TUESDAY	WEDNESDAY	THURSDAY	FRIDAY	SATURDAY	EXPENSES PAID BY COMPANY	EXPENSES PAID BY EMPLOYEE	DATE	DETAILS OF DISBURSEMENTS	AMOUNT
TRAVEL												
MEALS												
LODGING												
TRANSPORTATION												
OTHER												
TOTAL												

NET TOTAL: _____

DATE PRINTED: _____

G TERCC-363 - Snap-A-Part
Travel Expense Report, 11" x 8½"

CHANGE ORDER

YOUR COMPANY NAME
Address
CITY, STATE, ZIP CODE
Phone Number
Advertising Line
Change Order No. **001001**

TO _____ PHONE _____
ADDRESS _____ JOB NUMBER _____
JOB NAME AND LOCATION _____ COSTING CONTRACT NO. _____
DATE OF EXISTING CONTRACT _____

WE AGREE herby to make changes as specified above, at this price

PREVIOUS CONTRACT AMOUNT	\$
REVISED CONTRACT TOTAL	\$

ACCEPTED: The above prices and specifications of this Change Order are satisfactory and are hereby accepted. All work is to be performed under same terms and conditions as specified in original contract unless otherwise stipulated.

Date _____ Signature _____

D **COCC-583 - Snap-A-Part**
Change Order Form, 5½" x 8½"
Imprint area ¾" x 4"



E **FH-9977, 9979, 9980**
Forms Holder
Top or Side Opening

D **COCC-583 - Change Order Form**

Cat. No.	Wt.			Carbonless Lot Prices				
	Pts.	per 1000		250	500	1000	2000	3000
583-3	3	13#		89.91	129.84	215.54	383.19	558.43

Envelopes available on page 100. (9907) (R)

E **FH-9977, 9979, 9980 - Forms Holder**

Cat. No.	For Forms		Wt. each	Opens	Price Each
	FH-	Up To			
9977	5½" x 9½"	2#		Top	35.52
9979	8½" x 12"	3#		Top	54.44
9980	8½" x 12"	3#		Side	55.38

(R)

F **LT-584 - Letter of Transmittal**

Cat. No.	Wt.			Carbonless Lot Prices				
	LT-	Pts.	per 1000	250	500	1000	2000	3000
584-2	2	19#		94.07	137.54	232.18	418.96	606.58

Numbered by request only.
Envelopes available on page 100. (9909, 9911) (R)

G **CO-696 - Change Order Form**

Cat. No.	Wt.			Carbonless Lot Prices				
	CO-	Pts.	per 1000	250	500	1000	2000	3000
696-3	3	25#		117.88	185.80	326.82	609.18	897.47

Envelopes available on page 100. (9907) (R)

YOUR COMPANY NAME
Address
CITY, STATE, ZIP CODE
Phone Number
Advertising Line

LETTER OF TRANSMITTAL

TO _____
JOB _____
DATE _____

WE ARE SENDING YOU Attached Under separate cover via _____ the following items:
 Shop drawings Plans Items Samples Specifications
 Copy of letter Change order

COPIES	DATE	FILE	DESCRIPTION

THESE ARE TRANSMITTED as checked below:
 For approval Approved as submitted Resubmit _____ copies for approval
 For your use Approved as noted Submit _____ copies for distribution
 As requested Returned for corrections Return _____ corrected prints
 For review and comment FOR BIDS DUE _____ ON _____ PRINTS RETURNED AFTER LOAN TO US

REMARKS: _____

COPY TO: _____
DATE: _____
PRINTED IN U.S.A. IF ENCLOSURES ARE NOT AS NOTED, KINDLY NOTIFY US AT ONCE.

F **LT-584 - Snap-A-Part**
Letter of Transmittal, 8½" x 11"
Imprint area 1" x 5"

YOUR COMPANY NAME
Address
CITY, STATE, ZIP CODE
Phone Number
Advertising Line

CHANGE ORDER
001001

TO _____ PHONE _____ DATE _____
JOB NAME/NUMBER _____
JOB LOCATION _____

EXISTING CONTRACT NUMBER _____ EXISTING CONTRACT DATE _____ NEW EXTENSION _____ JOB PHONE _____

We hereby agree to make the change(s) specified below:

REVISION	DESCRIPTION	AMOUNT

NOTE: This Change Order becomes part of and in conformance with the existing contract.

WE AGREE hereby to make the change(s) specified above at this total price:

DATE	PREVIOUS CONTRACT AMOUNT	\$
AUTHORIZED SIGNATURE (CONTRACTOR)	REVISED CONTRACT TOTAL	\$

DATE OF ACCEPTANCE _____
SIGNATURE (OWNER) _____

COCC-583 - Snap-A-Part
PRINTED IN U.S.A.

G **CO-696 - Snap-A-Part**
Change Order Form, 8½" x 11"
Imprint area 1" x 4"

REPAIR ORDER

YOUR COMPANY NAME 001001

Address
CITY, STATE, ZIP CODE
Phone Number
Advertising Line

SERVICE WILL CALL WARRANTY DATE PURPOSES DATE
 INSTALL DELIVER PICKUP PARTS LABOR

NAME _____

STREET _____ APT. _____ HOUSE _____

CITY _____ PHONE _____ MODEL _____

TECHNICAL SERVICE PERFORMED AT HOME SHOP IF OTHER THAN ABOVE - SEE ADDRESS

QUAN. PART NUMBER PART DESCRIPTION PRICE AMOUNT

CLEANER, LUBRICANTS & MISCELLANEOUS

ESTIMATE CUSTOMER'S OK. REVISED ESTIMATE TIME & DATE CALLED BY WHOM APPROVED BY

CHARGES IF NOT REPAIRED: A replacement is returned at customer's expense unless authorized service is performed. A diagnosis and handling charge @_____ \$ **is to hold.**

ESTIMATED CHARGES INCLUDE: SERVICE CALL, SHOP LABOR, REMOVAL, REINSTALLATION AND PARTS. IF SPECIAL SHOP ANALYSIS/ADDITIONAL REPAIRS ARE NEEDED YOU WILL BE CONTACTED FOR AUTHORIZATION TO COVER ADDITIONAL CHARGES.

WARRANTY: I HAVE READ AND UNDERSTAND THE ABOVE ESTIMATE AND TERMS AND AUTHORIZE THE REMOVAL OF MY APPLIANCE TO YOUR SERVICE CENTER. I UNDERSTAND THAT NECESSARY REPAIRS WILL BE COMPLETED ON BEHALF OF THE SERVICE CENTER. I AGREE TO SIGN THIS REPAIR ORDER.

RECEIVED BY - TECHNICIAN _____ HIGH VOLTAGE REQUIRED X

ALLENANCE _____ MICROWAVE/AVANCE _____ CUSTOMER'S SIGNATURE _____

TECHNICAL SERVICE PERFORMED AT HOME SHOP IF OTHER THAN ABOVE - SEE ADDRESS

QUAN. PART NUMBER PART DESCRIPTION PRICE AMOUNT

LABOR

TOTAL PARTS

TAX

SERVICE CHARGE

REMOVAL & REINSTALLATION

TOTAL (C.O.D.)

PRINTED IN U.S.A.

001001

A TVRCC-569, TVR-669 - Snap-A-Part
Repair Estimate Order, 5 1/2" x 9 3/4"
Imprint area 1" x 4"

GENERAL REPAIR ORDER

YOUR COMPANY NAME 001001

Address
CITY, STATE, ZIP CODE
Phone Number
Advertising Line

NAME _____ DATE RECEIVED A.M. P.M.

ADDRESS _____ MAIL _____ DATE PROMISED A.M. P.M.

CITY _____ PHONE _____ MODEL NO. _____

APPLIANCE PICKUP SERVICE WARRANTY SERIAL NO.
 DELIVER INITIAL ESTIMATE

REPAIRED BY ESTIMATE DELIVERY CURS PICKUP C.O.D.
 HOME SHOP

CUSTOMER'S COMPLAINT _____

CITY, PART NO. DESCRIPTION AMOUNT

MAJOR LABOR PERFORMED

TOTAL PARTS

TAX

LABOR

PICKUP/DELIVERY OR SERVICE CALL

TAX

TOTAL (C.O.D.)

PRINTED IN U.S.A.

B GROCC-563, GRO-663 - Snap-A-Part
General Repair Order, 5 1/2" x 8 1/2"
Imprint area 1" x 4"

A TVRCC-569, TVR-669 - Repair Estimate Order

Cat. No.	Wt.	Carbonless Lot Prices					
TVRCC-	Pts.	per 1000	250	500	1000	2000	3000
569-4	4	26#	117.47	176.28	298.01	554.37	813.75
TVR-	Carbon Lot Prices						
669-4	4	27#	99.16	167.60	292.92	537.52	788.58

Last part is manila tag. (R)
Detachable 3/4" stub to match repair order number.

B GROCC-563, GRO-663 - General Repair Order

Cat. No.	Wt.	Carbonless Lot Prices					
GROCC-	Pts.	per 1000	250	500	1000	2000	3000
563-3	3	21#	89.91	129.84	215.54	383.19	558.43
GRO-	Carbon Lot Prices						
663-3	3	22#	81.17	113.00	181.64	318.29	458.27

(R)

C APRCC-567, APR-667 - Appliance Repair Form

Cat. No.	Wt.	Carbonless Lot Prices					
APRCC-	Pts.	per 1000	250	500	1000	2000	3000
567-4	4	27#	115.39	172.38	290.00	539.29	790.87
APR-	Carbon Lot Prices						
667-4	4	28#	107.17	164.06	284.70	522.44	765.70

Part 3 is an estimate and customer claim receipt. (R)
Last part is manila tag, printed with material and labor record.

APPLIANCE REPAIR ORDER

YOUR COMPANY NAME 001001

Address
CITY, STATE, ZIP CODE
Phone Number
Advertising Line

SERVICE WILL CALL WARRANTY DATE PURPOSES DATE
 INSTALL DELIVER PICKUP PARTS LABOR

NAME _____

STREET _____ APT. _____ HOUSE _____

CITY _____ PHONE _____ MODEL _____

TECHNICAL SERVICE PERFORMED AT HOME SHOP IF OTHER THAN ABOVE - SEE ADDRESS

QUAN. PART NUMBER PART DESCRIPTION PRICE AMOUNT

ESTIMATED CHARGES INCLUDE: SERVICE CALL, SHOP LABOR, REMOVAL, REINSTALLATION AND PARTS. IF SPECIAL SHOP ANALYSIS/ADDITIONAL REPAIRS ARE NEEDED YOU WILL BE CONTACTED FOR AUTHORIZATION TO COVER ADDITIONAL CHARGES.

RECEIVED BY - TECHNICIAN _____ HIGH VOLTAGE REQUIRED

INVOICE WRITTEN BY _____ TECHNICIAN SIGNATURE _____ CUSTOMER'S SIGNATURE _____

REASON OF EMPTY APPLIANCE PARTS BOXED _____

PRINTED IN U.S.A.

C APRCC-567, APR-667 - Snap-A-Part
Appliance Repair Form, 5 1/2" x 8 1/2"
Imprint area 1" x 4"

- NOTE:**
- See page 40 for Daily Time/Job Tickets.
 - See page 47 for Plumbing and Electrical Forms.

Use the Form Designed to Work for Your Repair Business!

YOUR COMPANY NAME
Address
CITY, STATE, ZIP CODE
Phone Number
Advertising Line

NAME _____ DATE _____
ADDRESS _____ PHONE _____
APARTMENT _____ DATE PROMISED _____
MAKE _____ MODEL NO. _____ SERIAL NO. _____
NATURE OF SERVICE _____
QTY. _____ DESCRIPTION _____ PRICE _____ AMOUNT _____
REMARKS _____
TECHNICIAN _____ DATE COMPLETED _____ TAX _____ TOTAL _____

0001001
PRINTED IN U.S.A.

C **SWO-207 - Register Form**
Service Work Order, 5½" x 8½"
Imprint area 1" x 5"

ACCEPTED

CUSTOMER _____ DATE _____
W.O. NO. _____ MATERIAL _____
NO. PCS. _____ SER. NO. _____
PART NO. _____
PART NAME _____
INSPECTOR _____
COMMENTS _____

SCRAP

PRODUCT PART NO. _____ DESCRIPTION _____
QTY. WT. _____ PRODUCT/JOB NO. _____ VENDOR _____
OPERATOR _____ DEPT./WORK CTR. NO. _____
REASON _____
DISPOSITION _____
CHARGE TO ACCT NO. _____
INSPECTED BY _____ APPROVED BY _____

INSPECTED

PART NUMBER _____
INSPECTION OK, APPROVED FOR USE _____
REPAIRS MADE DURING INSPECTION, APPROVED FOR USE _____
RETURN FOR REWORK AND/OR REPAIRS _____
RETURN TO VENDOR _____
COMMENTS _____
DATE _____ INITIALS _____

REJECTED

JOB NO. _____ P.O. NO. _____
PART NO. _____ SERIAL NO. _____
PART NAME _____
NO. OF PIECES REJECTED _____
REASON _____
INSPECTOR _____ DATE _____

REPAIRABLE OR RERWORK

CUSTOMER _____ DATE _____
JOB NO. _____ PART NAME _____
PART NO. _____ SER. NO. _____
P.O. NO. _____
NO. OF PIECES _____
DISPOSITION _____
INSR. _____ STAMP _____
REASON FOR RERWORK (Use reverse side)

D **PT-165, PTS-165 (w/string), PTW-165 (w/wire)**
2¾" x 4¾"

C **SWO-207 - Service Work Order**

Cat. No.	Pts.	Wt. per 1000	Carbonless Lot Prices				
			250	500	1000	2000	3000
207-2*	2	8#	74.62	97.50	137.44	228.54	315.17
207-3*	3	12#	84.40	116.84	178.83	302.80	432.17

*7 digit numbering only. (R)

D **PT-165, PTS-165, PTW-165 - Work Order Tags**

Cat. No.	Description	Wt. per 1000	Lot Prices			
			1000	2000	5000	10000
165-1	Accepted	5#	61.20	101.87	229.68	408.67
165-2	Scrap	5#	61.20	101.87	229.68	408.67
165-3	Inspected	5#	61.20	101.87	229.68	408.67
165-4	Rejected	5#	61.20	101.87	229.68	408.67
165-5	Repairable	5#	61.20	101.87	229.68	408.67
PTS- (with string)			Lot Prices			
165-1	Accepted	6#	79.51	138.58	321.31	591.92
165-2	Scrap	6#	79.51	138.58	321.31	591.92
165-3	Inspected	6#	79.51	138.58	321.31	591.92
165-4	Rejected	6#	79.51	138.58	321.31	591.92
165-5	Repairable	6#	79.51	138.58	321.31	591.92
PTW- (with wire)			Lot Prices			
165-1	Accepted	6#	80.13	139.72	324.43	598.05
165-2	Scrap	6#	80.13	139.72	324.43	598.05
165-3	Inspected	6#	80.13	139.72	324.43	598.05
165-4	Rejected	6#	80.13	139.72	324.43	598.05
165-5	Repairable	6#	80.13	139.72	324.43	598.05

Not available imprinted. (R)

E **SCB-115 - Service Call Book**

Cat. No.	Pts.	Wt. per 5 Bks	Carbonless Lot Prices				
			5 Bks	10 Bks	15 Bks	50 Bks	
115-2	2	5#	80.13	143.87	194.53	263.07	491.04

Numbered in red by request only.
Not available imprinted. (R)

SERVICE CALL DATE _____ TIME _____
VOICE _____ CALL TAKEN BY _____
ADDRESS _____ CALL GIVEN TO _____
SERVICE WANTED _____
DATE PROMISED _____ MON TUE WED THU FRI SAT SUN

SERVICE CALL DATE _____ TIME _____
VOICE _____ CALL TAKEN BY _____
ADDRESS _____ CALL GIVEN TO _____
SERVICE WANTED _____
DATE PROMISED _____ MON TUE WED THU FRI SAT SUN

E **SCB-115 - Wire Bound Book**

Service Call Book, 5" x 4¼"
5" x 8½" overall
150 receipts per book

A GSCC-652, GS-651 - Snap-A-Part
General Sales, 5½" x 8½"
Imprint area 1" x 5"

B GSCC-653, GS-654 - Snap-A-Part
General Sales, 4¼" x 7"
Imprint area 1" x 3½"

A GSCC-652, GS-651 - General Sales

Cat. No.	Pts.	Wt. per 1000	Carbonless Lot Prices				
			250	500	1000	2000	3000
GSCC-652-2	2	9#	77.43	105.72	168.32	293.12	415.32
GSCC-652-3	3	13#	89.91	129.84	215.54	383.19	558.43
GSCC-652-4	4	17#	95.63	138.37	228.12	407.84	594.83
GS-			Carbon Lot Prices				
GS-651-2	2	10#	73.68	96.88	150.75	258.18	363.32
GS-651-3	3	16#	81.28	113.00	181.64	318.29	458.28
GS-651-4	4	22#	84.60	117.88	188.92	332.44	479.28

(R)

B GSCC-653, GS-654 - General Sales

Cat. No.	Pts.	Wt. per 1000	Carbonless Lot Prices				
			250	500	1000	2000	3000
GSCC-653-2	2	6#	71.19	92.09	140.87	238.21	332.54
GSCC-653-3	3	9#	78.88	108.42	173.32	302.80	433.94
GS-			Carbon Lot Prices				
GS-654-2	2	7#	68.80	87.83	131.92	220.95	309.04
GS-654-3	3	10#	74.52	99.16	155.22	267.02	377.36

(R)

C GSCC-552 - General Sales

Cat. No.	Pts.	Wt. per 1000	Carbonless Lot Prices				
			250	500	1000	2000	3000
GSCC-552-3	3	13#	85.64	123.60	205.35	364.99	531.70

Bi-Lingual (R)

D GSDCC-643 - General Sales Delivery Form

Cat. No.	Pts.	Wt. per 1000	Carbonless Lot Prices				
			250	500	1000	2000	3000
GSDCC-643-2	2	9#	77.43	105.82	168.32	293.12	415.22

(R)

C GSCC-552 - Snap-A-Part
General Sales, 5½" x 8½"
Imprint area 1" x 5"
Bi-Lingual

D GSDCC-643 - Snap-A-Part
General Sales Delivery Form, 5½" x 8½"
Imprint area 1¼" x 3½"

NOTE:

Company Imprint

Includes your company's name, address and phone number in one of four colors! For blank forms, subtract 30%.

Starting Number

Choose a six-digit starting number for your imprinted form at no extra charge! Otherwise, we will start with 001001. Four, five and seven-digit numbering available at an additional charge. See page 142 for pricing.

Multi-part Color Sequence

Colors correspond to sequence and number of parts selected in your order unless otherwise specified.

Blank forms will be sequentially numbered unless specified otherwise.

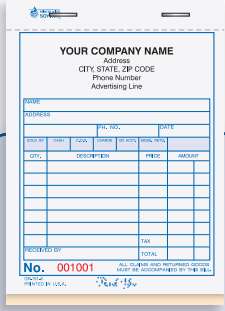

E GP-149*, GP-151 - Sales Book
General Sales, 4¼" x 5½"
Imprint area 1" x 3¾"
50 sets per book



F GP-154, GP-158* - Sales Book
General Sales, 4¼" x 7"
Imprint area 1" x 3¾"
50 sets per book

*Without layaway.

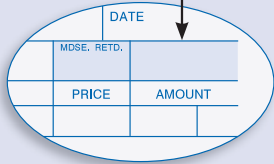

E GP-149*, GP-151 - General Sales Book

Cat. No.	GP-	Pts.	Wt. per 10 Bks	Carbonless Lot Prices			
				10 Bks	15 Bks	25 Bks	50 Bks
151-2	2	3#	96.25	124.02	181.22	311.94	571.64
151-3	3	4#	106.24	141.81	206.70	387.76	724.20
149-2*	2	3#	96.25	124.02	181.22	311.94	571.64
149-3*	3	4#	106.24	141.81	206.70	387.76	724.20

*Without layaway. (R)

F GP-154, GP-158* - General Sales Book

Cat. No.	GP-	Pts.	Wt. per 10 Bks	Carbonless Lot Prices			
				10 Bks	15 Bks	25 Bks	50 Bks
154-2	2	4#	110.50	144.30	206.70	370.92	708.40
154-3	3	5#	124.75	159.38	240.29	430.09	825.40
158-2*	2	4#	110.50	144.30	206.70	370.92	708.40
158-3*	3	5#	124.75	159.38	240.29	430.09	825.40

*Without layaway. (R)

G SOFCC-699, SOF-698 - Sales Order

Cat. No.	SOFCC-	Pts.	Wt. per 1000	Carbonless Lot Prices			
				250	500	1000	2000
699-3	3	25#	117.47	184.03	323.80	603.25	887.69

Cat. No.	SOF-	Pts.	Wt. per 1000	Carbon Lot Prices			
				250	500	1000	2000
698-3	3	29#	100.52	150.75	258.49	469.51	686.56

Envelopes available on page 100. (9907) (R)

H GSCC-670 - General Sales

Cat. No.	GSCC-	Pts.	Wt. per 1000	Carbonless Lot Prices			
				250	500	1000	2000
670-2	2	16#	94.07	137.54	232.18	418.96	606.58
670-3	3	25#	117.47	184.03	323.80	603.25	887.69
670-4	4	32#	139.52	228.64	412.93	784.52	1,155.70

Envelopes available on page 100. (9906) (R)

NOTE:

1 Day Blank **3 Day Imprint**

Shipping

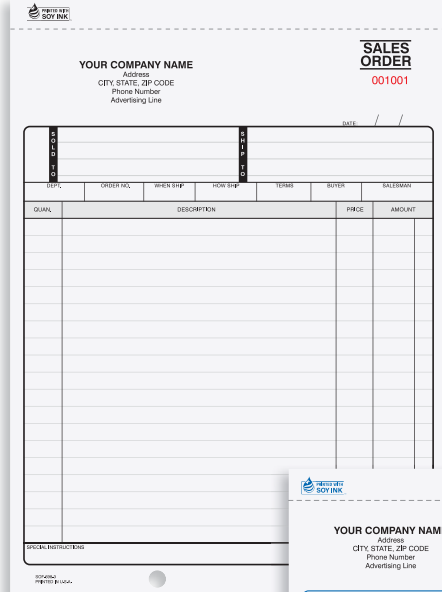

G SOFCC-699, SOF-698 - Snap-A-Part
Sales Order, 8½" x 11"
Imprint area 1" x 4"

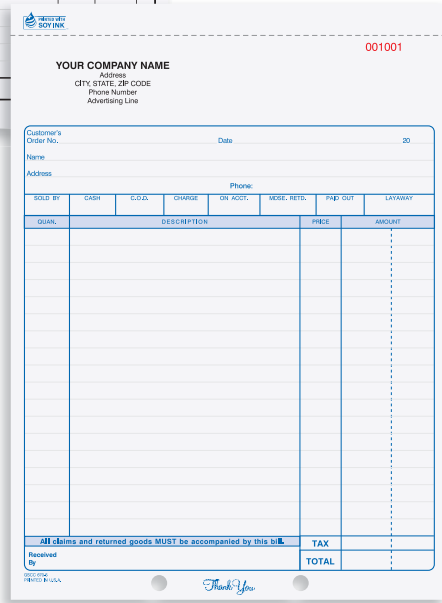

H GSCC-670 - Snap-A-Part
General Sales, 8½" x 11"
Imprint area 1" x 4"

BEST SELLER

YOUR COMPANY NAME
Address
CITY, STATE, ZIP CODE
Phone Number
Advertising Line

NAME
ADDRESS
CITY, STATE, ZIP CODE
PHONE NO.
DATE

SOLD BY	CASH	C.O.D.	CHARGE	ON ACCT.	MOSE.RETD.	PAYD OUT	LAWWAY
QTY.	DESCRIPTION					PRICE	AMOUNT
						TAX	
						TOTAL	

RECEIVED BY
No. 001001

ALL CLAIMS AND RETURNED GOODS MUST BE ACCOMPANIED BY THIS BILL.

SPINCO PRINTED IN U.S.A. *Thank You*

A GP-153, GP-159* - Sales Book
General Sales, 5½" x 8½"
Imprint area 1" x 5"
50 sets per book

*Without layaway.

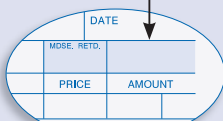

YOUR COMPANY NAME
Address
CITY, STATE, ZIP CODE
Phone Number
Advertising Line

CUSTOMER'S ORDER NO. PHONE DATE
NAME
ADDRESS

SOLD BY	CASH	C.O.D.	CHARGE	ON ACCT.	MOSE. RETD.	PAYD OUT	
QTY.	DESCRIPTION					PRICE	AMOUNT
						TAX	
						TOTAL	

SERVED BY
001001

ALL claims and returned goods MUST be accompanied by this bill. *Thank You*

B GP-139 - Sales Book
General Sales, 8½" x 5½"
Imprint area 1" x 3"
50 sets per book

A GP-153, GP-159* - General Sales Book

Cat. No.	GP-	Pts.	Wt. per 10 Bks	Carbonless Lot Prices			
				10 Bks	15 Bks	25 Bks	50 Bks
153-2	2	6#	139.00	187.25	286.68	514.33	994.71
153-3	3	7#	146.59	197.24	303.42	570.08	1,061.68
159-2*	2	6#	139.00	187.25	286.68	514.33	994.71
159-3*	3	7#	146.59	197.24	303.42	570.08	1,061.68

*Without layaway.

(R)

B GP-139 - General Sales Book

Cat. No.	GP-	Pts.	Wt. per 10 Bks	Carbonless Lot Prices			
				10 Bks	15 Bks	25 Bks	50 Bks
139-2	2	6#	139.00	187.25	286.68	514.33	994.71
139-3	3	7#	146.59	197.24	303.42	570.08	1,061.68

(R)

C RSB-142 - Road Service Book

Cat. No.	RSB-	Pts.	Wt. per 10 Bks	Carbonless Lot Prices			
				10 Bks	15 Bks	25 Bks	50 Bks
142-2	2	6#	139.00	187.25	286.68	514.33	994.71
142-3	3	7#	146.59	197.24	303.42	570.08	1,061.68

(R)

D MB-012 - General Sales Book

Cat. No.	MB-	Pts.	Wt. per 25 Bks	Carbonless Lot Prices			
				25 Bks	50 Bks	75 Bks	100 Bks
012-2	2	5#	61.31	96.46	105.20	122.67	203.58

Not available imprinted. No choice of starting number.

(R)

NOTE:



Includes your company's name, address and phone number in one of four colors! For blank forms, subtract 30%.



Colors correspond to sequence and number of parts selected in your order unless otherwise specified.



Choose a six-digit starting number for your imprinted form at no extra charge! Otherwise, we will start with 001001. Four, five and seven-digit numbering available at an additional charge. See page 142 for pricing.

Blank forms will be sequentially numbered unless specified otherwise.



ROAD SERVICE

YOUR COMPANY NAME
Address
CITY, STATE, ZIP CODE
Phone Number
Advertising Line
001001

DATE TIME DATE REQUESTED BY
LOCATION OF VEHICLE
NAME PHONE
ADDRESS

MILEAGE	SERVICE TIME	EXTRA PERSON
START	START	START
TOTAL	TOTAL	TOTAL

YEAR MAKE/MODEL/COLOR DRIVER

STATE LIC. NO. VEHICLE NO.

PROBLEM REPORTED	SERVICE RENDERED	SPECIAL EQUIPMENT	INDICATE DAMAGED AREAS ON VEHICLE
<input type="checkbox"/> LOCK-OUT	<input type="checkbox"/> BURNISHED TIRE	<input type="checkbox"/> WHEEL LIFT	<input type="checkbox"/> BRAKE LINE WINCHING
<input type="checkbox"/> FLAT TIRE	<input type="checkbox"/> FLAT BED/RAMP	<input type="checkbox"/> SNATCH BLOCKS	<input type="checkbox"/> SCOOTER/BLOCKS
<input type="checkbox"/> OUT OF GAS	<input type="checkbox"/> START	<input type="checkbox"/> BOLLY	
<input type="checkbox"/> WRECK			
<input type="checkbox"/> RECOVERY			

VEHICLE TOWED TO

REMARKS

OPERATOR'S SIGNATURE AUTHORIZED SIGNATURE

SPINCO PRINTED IN U.S.A. *Thank You*

Date _____

No. _____

Reg. No.	Clerk	ACCOUNT FORWARD
1		
2		
3		
4		
5		
6		
7		
8		
9		
10		
11		
12		
13		
14		
15		

12

For Account Started on Date → F Error → Found Return or Check

C RSB-142
Road Service Book, 5½" x 8½"
Imprint area 1" x 3"
50 sets per book

D MB-012 - Sales Book
General Sales, 3½" x 5½"
50 sets per book

E MB-258, MB-358 - Sales Book
General Sales, 5½" x 7"
50 sets per book

F MB-247, MB-347 - Sales Book
General Sales, 4½" x 7"
50 sets per book

G GP-152 - Sales Book
General Sales, 4¼" x 5½"
Imprint area 1" x 3¾"
50 sets per book

E MB-258, MB-358 - General Sales Book

Cat. No.	Wt.		Carbonless Lot Prices	
	MB-	Pts. per 10 Bks	10 Bks	
258-2	2	5#	43.84	
358-3	3	6#	50.60	

Not available imprinted. No choice of starting number. (R)

F MB-247, MB-347 - General Sales Book

Cat. No.	Wt.		Carbonless Lot Prices	
	MB-	Pts. per 10 Bks	10 Bks	
247-2	2	4#	40.51	
347-3	3	5#	43.84	

Not available imprinted. No choice of starting number. (R)

G GP-152 - General Sales Book

Cat. No.	Wt.		Carbonless Lot Prices				
	GP-	Pts. per 10 Bks	10 Bks	15 Bks	25 Bks	50 Bks	100 Bks
152-2	2	3#	96.25	124.02	181.22	311.94	571.64

(R)

H GP-155 - Service Station Sales Book

Cat. No.	Wt.		Carbonless Lot Prices				
	GP-	Pts. per 10 Bks	10 Bks	15 Bks	25 Bks	50 Bks	100 Bks
155-2	2	3#	96.25	124.02	181.22	311.94	571.64
155-3	3	4#	106.24	141.81	206.70	387.76	724.41

(R)

H GP-155 - Sales Book
Service Station Sales, 4¼" x 5½"
Imprint area 1" x 3¾"
50 sets per book

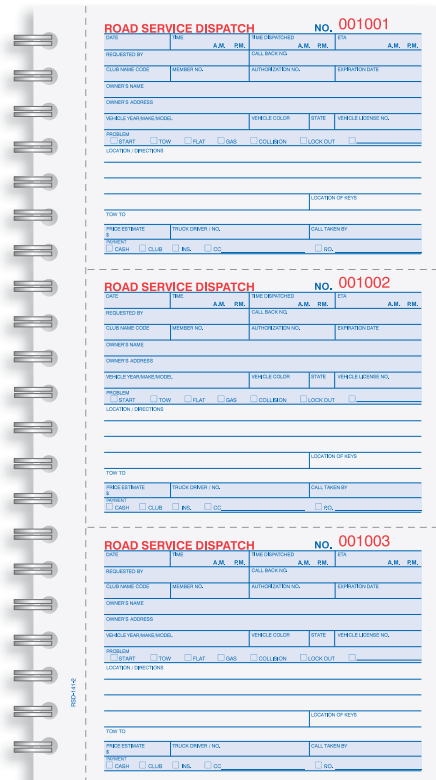

A RSD-141 - Wire Bound Book
Road Service Dispatch Book, 5 3/4" x 11" Overall
Receipt size 5" x 3 1/2"
150 sets per book

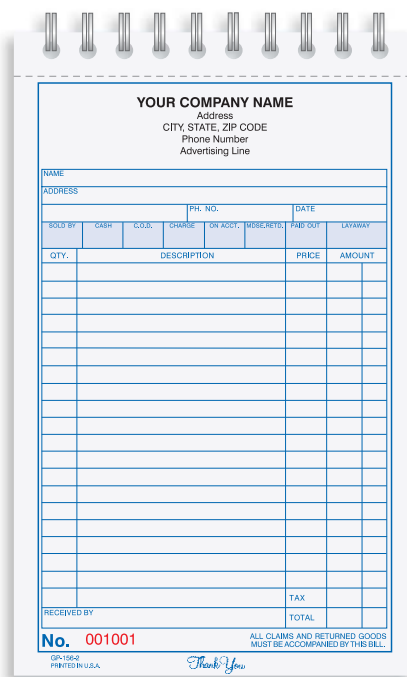

C GP-156 - Wire Bound Book
General Sales, 5 3/8" x 8 1/2"
Imprint area 1" x 5"
50 sets per book

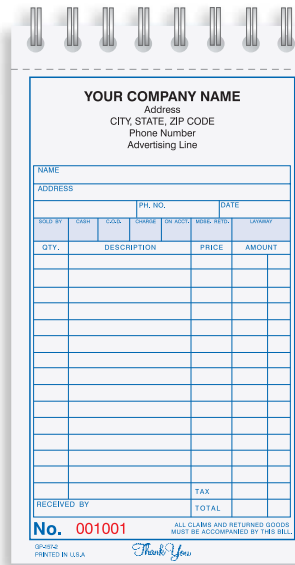

B GP-157 - Wire Bound Book
General Sales, 4 1/4" x 7"
Imprint area 1" x 3 3/8"
50 sets per book

A RSD-141 - Road Service Dispatch Book

Cat. No.	RSD-	Pts.	Wt. per 5 Bks	Carbonless Lot Prices				
				5 Bks	10 Bks	15 Bks	25 Bks	50 Bks
141-2		2	5#	76.91	133.69	180.80	298.64	592.12

Not available imprinted. No choice of starting number. (R)

B GP-157 - General Sales Book

Cat. No.	GP-	Pts.	Wt. per 10 Bks	Carbonless Lot Prices				
				10 Bks	15 Bks	25 Bks	50 Bks	100 Bks
157-2		2	4#	123.29	159.38	227.81	429.88	774.96
157-3		3	5#	136.68	179.66	265.56	472.00	910.16

(R)

C GP-156 - General Sales Book

Cat. No.	GP-	Pts.	Wt. per 10 Bks	Carbonless Lot Prices				
				10 Bks	15 Bks	25 Bks	50 Bks	100 Bks
156-2		2	6#	153.56	204.83	311.94	573.20	1,112.02
156-3		3	7#	163.75	215.02	332.96	623.74	1,196.57

(R)

NOTE:



Includes your company's name, address and phone number in one of four colors! For blank forms, subtract 30%.



Colors correspond to sequence and number of parts selected in your order unless otherwise specified.



Choose a six-digit starting number for your imprinted form at no extra charge! Otherwise, we will start with 001001. Four, five and seven-digit numbering available at an additional charge. See page 142 for pricing.



Blank forms will be sequentially numbered unless specified otherwise.

Register

YOUR COMPANY NAME
Address
CITY, STATE, ZIP CODE
Phone Number
Advertising Line

SOLD TO _____ PHONE _____

ADDRESS _____ CITY _____ STATE _____ ZIP _____

SOLD BY	DATE	CASH	CHECK	CHARGE	ON ACCT.	MOSE, RETD.	L'WAY	ALTER
QTY.	STYLE	DESCRIPTION	AMOUNT	COMMENTS				
SUB-TOTAL				<i>Thank You</i>				
TAX								
TOTAL								

Merchandise for return or exchange MUST be accompanied by this sales receipt.

0001001 _____ CUSTOMER SIGNATURE

AP-217-3 PRINTED IN U.S.A.

A AP-217 - Register Form
Apparel, 5½" x 8½"
Imprint area 1" x 5"

YOUR COMPANY NAME
Address
CITY, STATE, ZIP CODE
Phone Number
Advertising Line

SOLD TO _____ PHONE _____

ADDRESS _____ CITY _____ STATE _____ ZIP _____

SOLD BY	DATE	CASH	CHECK	CHARGE	ON ACCT.	MOSE, RETD.	L'WAY	ALTER
QTY.	STYLE	DESCRIPTION	AMOUNT	COMMENTS				
SUB-TOTAL				<i>Thank You</i>				
TAX								
TOTAL								

Merchandise for return or exchange MUST be accompanied by this sales receipt.

0001001 _____ CUSTOMER SIGNATURE

AP-232-2 PRINTED IN U.S.A.

B AP-232 - Register Form
Apparel, 4" x 6½"
Imprint area 1" x 3½"

YOUR COMPANY NAME
Address
CITY, STATE, ZIP CODE
Phone Number
Advertising Line

CUSTOMER ORDER NO. _____ PHONE _____ DATE _____

NAME _____ SPECIAL ORDER

ADDRESS _____ GIFT CERTIFICATE

LAY-A-WAY

TRADE-IN

SOLD BY	CASH	CHARGE	C.O.D.	CHECK	ON ACCT.	PAYD OUT	MOSE, RETD.
QTY.	STOCK NO.	DESCRIPTION/SIZE	PRICE	AMOUNT			
SPECIAL INSTRUCTIONS:				SUBTOTAL			
				TAX			
				TOTAL			
				DEPOSIT			
				BAL. DUE			

ALL claims and returned goods MUST be accompanied by this bill.

0001001 Rec'd by _____ *Thank You*

GSR-225-3 PRINTED IN U.S.A.

C GSR-225 - Register Form
Retail Sales, 5½" x 8½"
Imprint area 1" x 5"

A AP-217 - Apparel

Cat. No.	Pts.	Wt. per 1000	Carbonless Lot Prices				
			250	500	1000	2000	3000
217-2	2	8#	74.62	97.50	140.56	228.54	315.07
217-3	3	12#	84.40	116.84	178.83	302.80	432.07

(R)

B AP-232 - Apparel

Cat. No.	Pts.	Wt. per 1000	Carbonless Lot Prices				
			250	500	1000	2000	3000
232-2	2	5#	71.60	92.61	125.58	192.98	259.42

(R)

C GSR-225 - Retail Sales

Cat. No.	Pts.	Wt. per 1000	Carbonless Lot Prices				
			250	500	1000	2000	3000
225-2	2	8#	74.62	97.50	140.56	228.54	315.07
225-3	3	12#	84.40	116.84	178.83	302.80	432.07

(R)

NOTE:

Company Imprint

Includes your company's name, address and phone number in one of four colors! For blank forms, subtract 30%.

Starting Number

Choose a six-digit starting number for your imprinted form at no extra charge! Otherwise, we will start with 001001. Four, five and seven-digit numbering available at an additional charge. See page 142 for pricing.

Blank forms will be sequentially numbered unless specified otherwise.

Multi-part Color Sequence

Colors correspond to sequence and number of parts selected in your order unless otherwise specified.

1 Day Blank Shipping

3 Day Imprint

Call for pricing on larger quantities.

YOUR COMPANY NAME
Address
CITY, STATE, ZIP CODE
Phone Number
Advertising Line

Customer's Order No. _____ Date _____

SOLD BY	MOSE. SOLD		MOSE. RET'D.		RECD. ON		MSC. PD. OUT		
	CASH	CHARGE	C.O.D.	CASH	CHARGE	ACCT.	NOTE	MSC.	
QUAN.	STOCK NUMBER	DESCRIPTION				PRICE	AMOUNT		
Received by _____						Tax			
0001001						TOTAL \$			

SP-238-2 Printed in U.S.A.

D SP-238 - Register Form
Stock Parts, 4" x 6½"
Imprint area 1" x 3½"

YOUR COMPANY NAME
Address
CITY, STATE, ZIP CODE
Phone Number
Advertising Line

CUSTOMER'S ORDER NO. _____ PHONE _____ DATE _____

NAME _____

ADDRESS _____

MAKE _____ MILEAGE _____ LIC. # _____

SOLD BY	CASH		CHARGE		ON ACCT.		MOSE. RET'D.		MSC. PD. OUT	
	CASH	CHARGE	C.O.D.	CASH	CHARGE	ACCT.	NOTE	MSC.	PD. OUT	
QUAN.	DESCRIPTION				PRICE	AMOUNT				
Received by _____						Tax				
0001001						TOTAL \$				

All claims and returned goods MUST be accompanied by this bill.

RECEIVED BY _____

0001001

GSA-244-2 PRINTED IN U.S.A. Thank You

E GSA-244 - Register Form
Auto Service, 5½" x 8½"
Imprint area 1" x 5"

Business Solutions
Checks, Invoices, Envelopes and
Promotion Products. All this and
more at your fingertips.
Call Today!

YOUR COMPANY NAME
Address
CITY, STATE, ZIP CODE
Phone Number
Advertising Line

Customer's Order No. _____ Date _____

NAME _____

ADDRESS _____

MAKE _____ MILEAGE _____ LIC. # _____

SOLD BY	MOSE. SOLD		MOSE. RET'D.		RECD. ON		MSC. PD. OUT		
	CASH	CHARGE	C.O.D.	CASH	CHARGE	ACCT.	NOTE	MSC.	
QUAN.	STOCK NUMBER	DESCRIPTION				PRICE	AMOUNT		
Received by _____						Tax			
0001001						TOTAL \$			

In case of claims or returned goods, please present this bill.

SP-208-2 PRINTED IN U.S.A.

D SP-238 - Stock Parts

Cat. No.	SP-	Pts.	Wt. per 1000	Carbonless Lot Prices				
				250	500	1000	2000	3000
238-2	2	5#	71.60	92.61	125.58	192.98	259.42	
238-3	3	7#	81.17	104.78	149.29	240.60	332.54	

(R)

E GSA-244 - Auto Service

Cat. No.	GSA-	Pts.	Wt. per 1000	Carbonless Lot Prices				
				250	500	1000	2000	3000
244-2	2	8#	74.62	97.50	140.56	228.54	315.07	
244-3	3	12#	84.40	116.84	178.83	302.80	432.07	

(R)

F SP-208 - Stock Parts

Cat. No.	SP-	Pts.	Wt. per 1000	Carbonless Lot Prices				
				250	500	1000	2000	3000
208-2	2	8#	74.62	97.50	140.56	228.54	315.07	
208-3	3	12#	84.40	116.84	178.83	302.80	432.07	

(R)

F SP-208 - Register Form
Stock Parts, 5½" x 8½"
Imprint area 1" x 5"

ROAD SERVICE

YOUR COMPANY NAME
Address
CITY, STATE, ZIP CODE
Phone Number
Advertising Line

DATE	TIME	<input type="checkbox"/> A.M. <input type="checkbox"/> P.M.	REQUESTED BY
LOCATION OF VEHICLE			
NAME		PHONE	
ADDRESS		ZIP	
MILEAGE		SERVICE TIME	
FINISH	FINISH	EXTRA PERSON	
START	START	START	
TOTAL		TOTAL	
YEAR	MAKE/MODEL/COLOR	DRIVER	
STATE	LIC. NO.	VEHICLE ID. NO.	
PROBLEM REPORTED	SERVICE RENDERED	SPECIAL EQUIPMENT	INDICATE DAMAGED AREAS ON VEHICLE
<input type="checkbox"/> LOCK OUT <input type="checkbox"/> FLAT TIRE <input type="checkbox"/> OUT OF GAS <input type="checkbox"/> WRECK <input type="checkbox"/> RECOVERY <input type="checkbox"/>	<input type="checkbox"/> SLING/SHOBT TOW <input type="checkbox"/> WHEEL LIFT <input type="checkbox"/> FLAT BED/RAMP <input type="checkbox"/> START <input type="checkbox"/>	<input type="checkbox"/> SINGLE LINE WINCHING <input type="checkbox"/> DUAL LINE WINCHING <input type="checkbox"/> SNATCH BLOCKS <input type="checkbox"/> SCOTCH BLOCKS <input type="checkbox"/> DOLLY <input type="checkbox"/>	 KEYS LEFT <input type="checkbox"/> Y <input type="checkbox"/> N RADIO <input type="checkbox"/> Y <input type="checkbox"/> N
VEHICLE TOWED TO		REMARKS	
OPERATOR'S SIGNATURE		AUTHORIZED SIGNATURE	
0001001		0001001	

Thank You

A **RS-242 - Register Form**
Road Service, 5½" x 8½"
Imprint area 1" x 5"

YOUR COMPANY NAME
Address
CITY, STATE, ZIP CODE
Phone Number
Advertising Line

Customer's Order No. _____ Date _____

Name _____ Address _____

PAID BY	CASH	C. O. D.	CHARGE	ON ACCT.	MORE RETO.	PAID OUT
QUAN.	DESCRIPTION		PRICE	AMOUNT		
	GALS.	BASOIL				
	GTS.	DIESEL				
	GREASE					
	LUBRICATION					
	TAX					
CAT. NO.	LICENSE NO.	MILEAGE	TOTAL			

0001001 Rec'd by _____
All claims and returned goods MUST be accompanied by this bill.

Thank You

B **SS-213 - Register Form**
Service Station, 4" x 6"
Imprint area 1" x 3½"

YOUR COMPANY NAME
Address
CITY, STATE, ZIP CODE
Phone Number
Advertising Line

Order No. _____ Date _____

Name _____ Address _____

QUAN.	DESCRIPTION	PRICE	AMOUNT
	GALS./LITERS LEAD FREE		
	GALS./LITERS REGULAR		
	GALS./LITERS DIESEL		
	GTS. OIL		
TAX		TOTAL	

0001001 Rec'd by _____
All claims and returned goods MUST be accompanied by this bill.

Thank You

C **SS-236 - Register Form**
Service Station, 4" x 6½"
Imprint area 1" x 3½"

REPAIR ORDER

YOUR COMPANY NAME
Address
CITY, STATE, ZIP CODE
Phone Number
Advertising Line

NAME	DATE
ADDRESS	PH. NO.
ODOMETER READING	VIN. NO.
MAKE AND MODEL	LICENSE NO. AND STATE
MOTOR NO.	
LUBR. OIL	BATTERY
ORANGE OIL	FLAT TIRE
WIPERS	TRAVEL
DEF.	WASH
POUSH	
DESCRIPTION	INSTRUCTIONS
	AMOUNT

QTY	PART NO.	NAME OF PART	SALE AMT.	Total Labor
				Total Parts
				Environmental Charge
				Oil/Grease
				Tires/Tubes
				Shop/Supplies
				Other
				TOTAL
				TAX
				TOTAL AMOUNT

I hereby authorize the above repair work to be done along with the necessary material, and hereby grant you and/or your employees permission to operate the car, truck or vehicle herein described on streets, highways or elsewhere for the purpose of testing and/or inspection. An express mechanic's lien is hereby acknowledged on above car, truck or vehicle to secure the amount of repairs thereto.

Work Authorized by _____ Date Promised _____
Delivered to _____ Date Delivered _____
0001001

Thank You

D **ARO-282 - Register Form**
Auto Repair, 5½" x 8½"
Imprint area 1" x 5"

A **RS-242 - Road Service**

Cat. No.	RS-	Pts.	Wt. per 1000	Carbonless Lot Prices			
				250	500	1000	2000
242-2	2	8#	74.62	97.50	140.56	228.54	315.07
242-3	3	12#	84.40	116.84	178.83	302.80	432.07

(R)

B **SS-213 - Service Station**

Cat. No.	SS-	Pts.	Wt. per 1000	Carbonless Lot Prices			
				250	500	1000	2000
213-2	2	5#	67.03	82.00	111.12	170.92	230.41
213-3	3	6#	73.79	95.32	135.77	219.08	302.48

(R)

C **SS-236 - Service Station**

Cat. No.	SS-	Pts.	Wt. per 1000	Carbonless Lot Prices			
				250	500	1000	2000
236-2	2	5#	71.60	92.61	125.58	192.98	259.42
236-3	3	7#	81.17	104.78	149.29	240.60	332.54

(R)

D **ARO-282 - Auto Repair**

Cat. No.	ARO-	Pts.	Wt. per 1000	Carbonless Lot Prices			
				250	500	1000	2000
282-2	2	8#	70.36	91.88	132.55	215.44	297.08
282-3	3	12#	79.61	110.19	168.53	285.43	407.32

(R)

NOTE:



Includes your company's name, address and phone number in one of four colors! For blank forms, subtract 30%.



Colors correspond to sequence and number of parts selected in your order unless otherwise specified.



Choose a six-digit starting number for your imprinted form at no extra charge! Otherwise, we will start with 001001. Four, five and seven-digit numbering available at an additional charge. See page 142 for pricing.

Blank forms will be sequentially numbered unless specified otherwise.

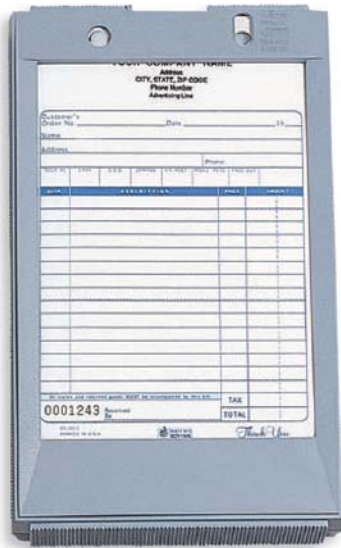

A Register Machine
(For three sizes of forms)
MAC-9970, 4" x 6", 4" x 6½"
Holds: 160 2pt, 110 3pt, 80 4pt
MAC-9973, 5½" x 8½"
Holds: 160 2pt, 110 3pt, 80 4pt

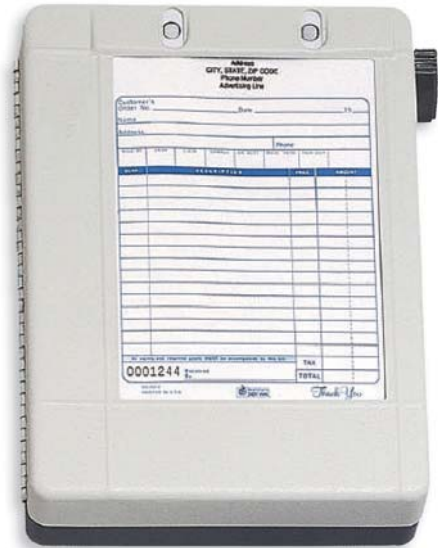

B Register Machine
(For three sizes of forms)
MAC-9972, 4" x 6", 4" x 6½"
Holds: 250 2pt, 160 3pt, 125 4pt
MAC-9975, 5½" x 8½"
Holds: 240 2pt, 140 3pt, 120 4pt

A MAC-9970, MAC-9973 - Register Machine – Heavy Plastic

Cat. No.	Size	Wt. each	Price each
9970	4" x 6", 4" x 6½"	2#	38.64
9973	5½" x 8½"	2#	52.26

(R)

B MAC-9972, MAC-9975 - Register Machine – Metal

Cat. No.	Size	Wt. each	Price each
9972	4" x 6", 4" x 6½"	4#	196.51
9975	5½" x 8½"	6#	232.28

Features pop-out drawer, thumb ejector and rubber feet.

(R)

C MAC-9968, MAC-9969 - Register Machine – Plastic

Cat. No.	Size	Wt. each	Price each
9968	4" x 6", 4" x 6½"	1#	10.35
9969	5½" x 8½"	1#	16.48

(R)



C Register Machine
(For three sizes of forms)
MAC-9968, 4" x 6", 4" x 6½"
Holds: 100 2pt, 75 3pt, 50 4pt
MAC-9969, 5½" x 8½"
Holds: 120 2pt, 70 3pt, 60 4pt

NOTE:



- ! See pages 6-19 for more Automotive Forms.
- ! Use a Sturdy Aluminum Form Holder for your Snap-A-Part Forms. See page 43.

FREE MACHINE
with your order of
1,000 or more imprinted Register Forms!
Choose from **MAC-9968**
or **MAC-9969.**

Cash Receipt Books

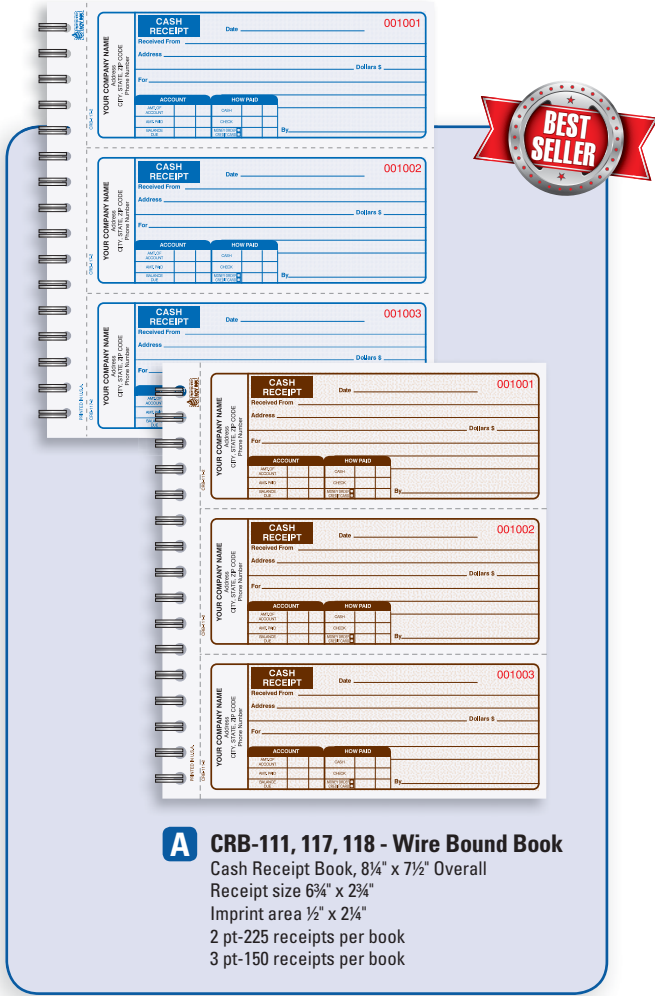

A **CRB-111, 117, 118 - Wire Bound Book**
Cash Receipt Book, 8¼" x 7½" Overall
Receipt size 6¾" x 2¾"
Imprint area ½" x 2¼"
2 pt-225 receipts per book
3 pt-150 receipts per book

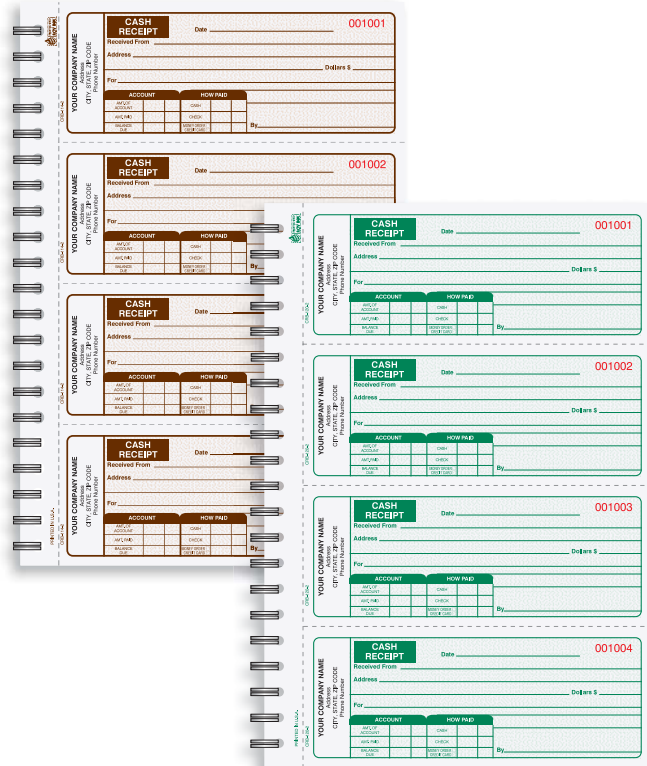

B **CRB-114, 119, 120 - Wire Bound Book**
Cash Receipt Book, 7½" x 11" Overall
Receipt size 6¾" x 2¾"
Imprint area ½" x 2¼"
2 pt-300 receipts per book
3 pt-200 receipts per book

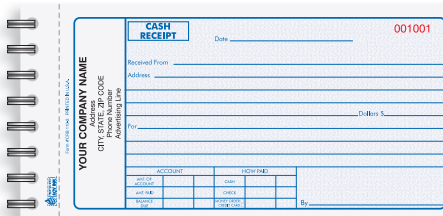

C **CRB-110 - Wire Bound Book**
Cash Receipt Book, 7¾" x 4¼"
Imprint area 1" x 3½"
2 pt-75 receipts per book
3 pt-50 receipts per book

A **CRB-111, 117, 118 - Cash Receipt Book**

Cat. No.	CRB-	Color	Pts.	Wt. per 5 Bks	Carbonless Lot Prices				
					5 Bks	10 Bks	15 Bks	25 Bks	50 Bks
111-2	Brown	2	5#	158.66	246.95	339.09	517.24	981.19	
111-3	Brown	3	5#	158.66	246.95	339.09	517.24	981.19	
117-2	Blue	2	5#	158.66	246.95	339.09	517.24	981.19	
117-3	Blue	3	5#	158.66	246.95	339.09	517.24	981.19	
118-2	Green	2	5#	158.66	246.95	339.09	517.24	981.19	
118-3	Green	3	5#	158.66	246.95	339.09	517.24	981.19	

(R)

B **CRB-114, 119, 120 - Cash Receipt Book**

Cat. No.	CRB-	Color	Pts.	Wt. per 5 Bks	Carbonless Lot Prices				
					5 Bks	10 Bks	15 Bks	25 Bks	50 Bks
114-2	Brown	2	6#	209.61	338.78	470.44	688.01	1,207.91	
114-3	Brown	3	6#	209.61	338.78	470.44	688.01	1,207.91	
119-2	Blue	2	6#	209.61	338.78	470.44	688.01	1,207.91	
119-3	Blue	3	6#	209.61	338.78	470.44	688.01	1,207.91	
120-2	Green	2	6#	209.61	338.78	470.44	688.01	1,207.91	
120-3	Green	3	6#	209.61	338.78	470.44	688.01	1,207.91	

(R)

C **CRB-110 - Cash Receipt Book**

Cat. No.	CRB-	Pts.	Wt. per 5 Bks	Carbonless Lot Prices				
				5 Bks	10 Bks	15 Bks	25 Bks	50 Bks
110-2		2	3#	125.27	192.87	263.07	416.47	779.74
110-3		3	3#	125.27	192.87	263.07	416.47	779.74

(R)

Additional Cash Receipt Books on Page 16.

NEW
ITEM

YOUR COMPANY NAME
Address
CITY, STATE, ZIP CODE
Phone Number

NO. _____ DATE _____
PURCHASE ORDER
SHOW THE NUMBER
ON YOUR INVOICE

001001

QUANTITY	DESCRIPTION	PRICE	AMOUNT

FOR JOB NO. _____ ACCOUNT _____ APPROVED BY _____

TO: _____
Address
CITY, STATE, ZIP CODE
Phone Number

NO. _____ DATE _____
PURCHASE ORDER
SHOW THE NUMBER
ON YOUR INVOICE

001002

QUANTITY	DESCRIPTION	PRICE	AMOUNT

FOR JOB NO. _____ ACCOUNT _____ APPROVED BY _____

YOUR COMPANY NAME
Address
CITY, STATE, ZIP CODE
Phone Number

NO. _____ DATE _____
PURCHASE ORDER
SHOW THE NUMBER
ON YOUR INVOICE

001003

QUANTITY	DESCRIPTION	PRICE	AMOUNT

FOR JOB NO. _____ ACCOUNT _____ APPROVED BY _____

TO: _____
Address
CITY, STATE, ZIP CODE
Phone Number

NO. _____ DATE _____
PURCHASE ORDER
SHOW THE NUMBER
ON YOUR INVOICE

001004

QUANTITY	DESCRIPTION	PRICE	AMOUNT

FOR JOB NO. _____ ACCOUNT _____ APPROVED BY _____

A NC-124 - Wire Bound Book
Purchase Order Book, 8¼" x 11" overall
Receipt size 7½" x 2¾"
Imprint area ½" x 5½"
2pt-200 receipts per book
3pt-200 receipts per book

BEST
SELLER

YOUR COMPANY NAME
Address
CITY, STATE, ZIP CODE
Phone Number

NO. _____ DATE _____
PURCHASE ORDER
SHOW THE NUMBER
ON YOUR INVOICE

001001

QUANTITY	DESCRIPTION	PRICE	AMOUNT

FOR JOB NO. _____ ACCOUNT _____ APPROVED BY _____

Date _____
To: _____
Address
CITY, STATE, ZIP CODE
Phone Number

NO. _____ DATE _____
PURCHASE ORDER
SHOW THE NUMBER
ON YOUR INVOICE

001002

QUANTITY	DESCRIPTION	PRICE	AMOUNT

FOR JOB NO. _____ ACCOUNT _____ APPROVED BY _____

YOUR COMPANY NAME
Address
CITY, STATE, ZIP CODE
Phone Number

NO. _____ DATE _____
PURCHASE ORDER
SHOW THE NUMBER
ON YOUR INVOICE

001003

QUANTITY	DESCRIPTION	PRICE	AMOUNT

FOR JOB NO. _____ ACCOUNT _____ APPROVED BY _____

Date _____
To: _____
Address
CITY, STATE, ZIP CODE
Phone Number

NO. _____ DATE _____
PURCHASE ORDER
SHOW THE NUMBER
ON YOUR INVOICE

001004

QUANTITY	DESCRIPTION	PRICE	AMOUNT

FOR JOB NO. _____ ACCOUNT _____ APPROVED BY _____

B POB-312 - Wire Bound Book
Purchase Order Book, 11" x 8½" overall
Receipt size 8½" x 2¾"
Imprint area ¾" x 2½"
200 receipts per book

YOUR COMPANY NAME
Address
CITY, STATE, ZIP CODE
Phone Number

NO. _____ DATE _____
PURCHASE ORDER
SHOW THE NUMBER
ON YOUR INVOICE

001001

QUANTITY	DESCRIPTION	PRICE	AMOUNT

FOR JOB NO. _____ ACCOUNT _____ APPROVED BY _____

Date _____
To: _____
Address
CITY, STATE, ZIP CODE
Phone Number

NO. _____ DATE _____
PURCHASE ORDER
SHOW THE NUMBER
ON YOUR INVOICE

001002

QUANTITY	DESCRIPTION	PRICE	AMOUNT

FOR JOB NO. _____ ACCOUNT _____ APPROVED BY _____

YOUR COMPANY NAME
Address
CITY, STATE, ZIP CODE
Phone Number

NO. _____ DATE _____
PURCHASE ORDER
SHOW THE NUMBER
ON YOUR INVOICE

001003

QUANTITY	DESCRIPTION	PRICE	AMOUNT

FOR JOB NO. _____ ACCOUNT _____ APPROVED BY _____

Date _____
To: _____
Address
CITY, STATE, ZIP CODE
Phone Number

NO. _____ DATE _____
PURCHASE ORDER
SHOW THE NUMBER
ON YOUR INVOICE

001004

QUANTITY	DESCRIPTION	PRICE	AMOUNT

FOR JOB NO. _____ ACCOUNT _____ APPROVED BY _____

A NC-124 - Purchase Order Book

Cat. No.	Pts.	Wt. per 5Bks	Carbonless Lot Prices				
			5 Bks	10 Bks	15 Bks	25 Bks	50 Bks
124-2	2	5#	81.75	128.67	171.00	248.75	458.34
124-3	3	7#	108.92	171.17	228.00	332.50	610.83

Envelopes available on page 100. (9906) (R)

B POB-312 - Purchase Order Book

Cat. No.	Pts.	Wt. per 5Bks	Carbonless Lot Prices				
			5 Bks	10 Bks	15 Bks	25 Bks	50 Bks
312-3	3	6#	209.61	338.99	470.34	657.96	1,315.03

Envelopes available on page 100. (9906) (R)

C POB-311 - Purchase Order Book

Cat. No.	Pts.	Wt. per 5Bks	Carbonless Lot Prices				
			5 Bks	10 Bks	15 Bks	25 Bks	50 Bks
311-3	3	5#	158.66	246.95	339.09	517.24	981.19

Envelopes available on page 100. (9906) (R)

NOTE:

Company Imprint

Includes your company's name, address and phone number in one of four colors! For blank forms, subtract 30%.

Multi-part Color Sequence

Colors correspond to sequence and number of parts selected in your order unless otherwise specified.

Starting Number

Choose a six-digit starting number for your imprinted form at no extra charge! Otherwise, we will start with 001001. Four, five and seven-digit numbering available at an additional charge. See page 142 for pricing.

1 Day Blank

3 Day Imprint

Shipping

Blank forms will be sequentially numbered unless specified otherwise.

Purchase Orders



YOUR COMPANY NAME
Address
CITY, STATE, ZIP CODE
Phone Number
Advertising Line

PURCHASE ORDER
001001

PLEASE ENTER OUR ORDER FOR THE FOLLOWING — TO BE SHIPPED AS DIRECTED

QTY. ORDERED	QTY. RECEIVED	DESCRIPTION	UNIT PRICE	AMOUNT

ITEMS: _____

DATE ORDERED: _____ DATE WANTED: _____ SHIP IN: _____ TERMS: _____ PAID: _____

BY: _____ PURCHASING AGENT

POCC-704 PRINTED IN U.S.A.

A **POCC-707, PO-700 - Snap-A-Part**
Purchase Order, 8½" x 11"
Imprint area 1" x 4"

YOUR COMPANY NAME
Address
CITY, STATE, ZIP CODE
Phone Number
Advertising Line

PURCHASE ORDER
001001

PLEASE ENTER OUR ORDER FOR THE FOLLOWING — TO BE SHIPPED AS DIRECTED

QTY. ORDERED	QTY. RECEIVED	DESCRIPTION	UNIT PRICE	AMOUNT

ITEMS: _____

DATE ORDERED: _____ DATE WANTED: _____ SHIP IN: _____ TERMS: _____ PAID: _____

BY: _____ PURCHASING AGENT

POCC-702 PRINTED IN U.S.A.

B **POCC-702, PO-701 - Snap-A-Part**
Purchase Order, 8½" x 8½"
Imprint area 1" x 4"

YOUR COMPANY NAME
Address
CITY, STATE, ZIP CODE
Phone Number
Advertising Line

PURCHASE ORDER
001001

PLEASE ENTER OUR ORDER FOR THE FOLLOWING — TO BE SHIPPED AS DIRECTED

QTY. ORDERED	QTY. RECEIVED	DESCRIPTION	UNIT PRICE	AMOUNT

ITEMS: _____

DATE ORDERED: _____ DATE WANTED: _____ SHIP IN: _____ TERMS: _____ PAID: _____

BY: _____ PURCHASING AGENT

POCC-704 PRINTED IN U.S.A.

C **POCC-704, PO-703 - Snap-A-Part**
Purchase Order, 8½" x 7"
Imprint area 1" x 4"

A **POCC-707, PO-700 - Purchase Order**

Cat. No.	Pts.	Wt. per 1000	Carbonless Lot Prices				
			250	500	1000	2000	3000
707-2	2	16#	94.07	137.54	232.18	418.96	606.58
707-3	3	25#	117.47	184.03	323.80	603.25	887.69
707-4	4	32#	139.52	228.64	412.93	784.52	1,155.70
707-5	5	40#	160.11	269.10	498.00	962.81	1,409.88
PO-			Carbon Lot Prices				
700-2	2	19#	85.64	121.53	199.94	356.25	510.28
700-3	3	29#	100.52	150.75	258.49	469.51	686.56
700-4	4	39#	114.56	179.66	314.76	588.38	860.96

Envelopes available on page 100. (9907) (R)

B **POCC-702, PO-701 - Purchase Order**

Cat. No.	Pts.	Wt. per 1000	Carbonless Lot Prices				
			250	500	1000	2000	3000
702-3	3	20#	104.16	158.44	273.36	502.48	733.67
702-4	4	26#	121.52	192.98	344.60	641.63	941.77
PO-			Carbon Lot Prices				
701-3	3	22#	91.36	132.65	221.68	398.48	576.63

Envelopes available on page 100. (9907) (R)

C **POCC-704, PO-703 - Purchase Order**

Cat. No.	Pts.	Wt. per 1000	Carbonless Lot Prices				
			250	500	1000	2000	3000
704-2	2	12#	82.94	115.70	187.77	329.94	478.87
704-3	3	16#	99.06	148.56	252.36	460.88	669.19
PO-			Carbon Lot Prices				
703-3	3	18#	87.21	124.54	206.70	368.21	531.80
703-4	4	25#	96.88	144.20	245.18	445.80	647.24

Envelopes available on page 100. (9907) (R)

NOTE:

! For an English/Spanish Bi-Lingual Purchase Order, POCC-717 is the form you need.

YOUR COMPANY NAME
Address
CITY, STATE, ZIP CODE
Phone Number
Advertising Line
001001

REQ. NO. _____ DATE _____

TO: _____
ADDRESS _____
SHIP TO: _____
ADDRESS _____

FOR	DATE REQUIRED	HOW SHIP	TERMS

QUANTITY	PLEASE SUPPLY ITEMS LISTED BELOW	PRICE	UNIT
1			
2			
3			
4			
5			
6			
7			
8			
9			
10			
11			
12			

IMPORTANT: OUR ORDER NUMBER MUST APPEAR ON ALL INVOICES, PACKAGES, ETC. PLEASE NOTIFY US IMMEDIATELY IF YOU ARE UNABLE TO SHIP COMPLETE ORDER BY DATE SPECIFIED.

PLEASE SEND _____ COPIES OF YOUR INVOICE

PROCESSED IN U.S.A. PURCHASE AGENT

D POCC-706 - Snap-A-Part
Purchase Order, 5 3/8" x 8 1/2"
Imprint area 7/8" x 3"

YOUR COMPANY NAME
Address
CITY, STATE, ZIP CODE
Phone Number
Advertising Line
001001

THIS NUMBER MUST APPEAR ON ALL CORRESPONDENCE, INVOICES, SHIPPING PAPERS AND PACKAGES.

TO: _____
ADDRESS _____
SHIP TO: _____
ADDRESS _____

DATE ORDERED FROM PLSK	DATE ORDERED FROM US	SHIP TO:	TERMS	COUL. TOOL

QUANTITY	DESCRIPTION	UNIT PRICE	AMOUNT

PLEASE ENTER OUR ORDER FOR THE FOLLOWING TO BE SHIPPED AS SPECIFIED

GOODS ARE SUBJECT TO OUR INSPECTION AND APPROVAL. IF GOODS ARE NOT ACCEPTED, YOU WILL BE NOTIFIED IMMEDIATELY. NOTIFY US IMMEDIATELY IF YOU ARE UNABLE TO SHIP COMPLETE ORDER BY DATE SPECIFIED.

PROCESSED IN U.S.A. PURCHASE AGENT

E POCC-708 - Snap-A-Part
Purchase Order, 8 1/2" x 8 1/2"
Imprint area 1" x 4"

D POCC-706 - Purchase Order

Cat. No.	Pts.	Wt. per 1000	Carbonless Lot Prices				
			250	500	1000	2000	3000
706-2	2	9#	77.43	105.82	168.32	293.12	415.22
706-3	3	13#	89.91	129.84	215.54	383.19	558.43

Envelopes available on page 100. (9919) (R)

E POCC-708 - Purchase Order

Cat. No.	Pts.	Wt. per 1000	Carbonless Lot Prices				
			250	500	1000	2000	3000
708-3	3	20#	104.16	158.44	273.36	502.48	733.67

Envelopes available on page 100. (9907) (R)

F POCC-717 - Purchase Order

Cat. No.	Pts.	Wt. per 1000	Carbonless Lot Prices				
			250	500	1000	2000	3000
717-3	3	25#	117.47	184.03	323.80	603.25	887.69

Envelopes available on page 100. (9907) (R)
Bi-Lingual

YOUR COMPANY NAME
Address
CITY, STATE, ZIP CODE
Phone Number
Advertising Line
001001

THIS NUMBER MUST APPEAR ON ALL CORRESPONDENCE, INVOICES, SHIPPING PAPERS AND PACKAGES. THIS NUMBER IS REQUIRED BY YOUR SA CORRESPONDENT TO OBTAIN FACTURING, LOG PROFILES, ETC. REQUIRED.

TO: _____
ADDRESS _____
SHIP TO: _____
ADDRESS _____

DATE ORDERED FROM PLSK	DATE ORDERED FROM US	SHIP TO:	TERMS	COUL. TOOL

QUANTITY	DESCRIPTION	UNIT PRICE	AMOUNT

PLEASE ENTER OUR ORDER FOR THE FOLLOWING TO BE SHIPPED AS SPECIFIED. FOR ORDER AGENTS: REQUEST ORDER FROM US. SEE DATE ORDERED FROM PLSK.

GOODS ARE SUBJECT TO OUR INSPECTION AND APPROVAL. IF GOODS ARE NOT ACCEPTED, YOU WILL BE NOTIFIED IMMEDIATELY. NOTIFY US IMMEDIATELY IF YOU ARE UNABLE TO SHIP COMPLETE ORDER BY DATE SPECIFIED.

PROCESSED IN U.S.A. PURCHASE AGENT

F POCC-717 - Snap-A-Part
Purchase Order, 8 1/2" x 11"
Imprint area 1" x 4"
Bi-Lingual

NOTE:

Company Imprint

Includes your company's name, address and phone number in one of four colors! For blank forms, subtract 30%.

Starting Number

Choose a six-digit starting number for your imprinted form at no extra charge! Otherwise, we will start with 001001. Four, five and seven-digit numbering available at an additional charge. See page 142 for pricing.

Blank forms will be sequentially numbered unless specified otherwise.

Multi-part Color Sequence

Colors correspond to sequence and number of parts selected in your order unless otherwise specified.

1
Day
Blank

3
Day
Imprint

Shipping

Shipping & Receiving

Keep Your Shipments Moving!

Preprinted headings and plenty of room to list number of units shipped, type of packaging, weight, rate, charges and more make these forms easy to use.

Includes three areas for imprinting your information
8½" x 7" or 8½" x 11"

At the Top: (Choose one)

- 1 Your company name - 1 line of type, or
- 2 Your company name - 3 lines of type, or
- 4 Your company name, address and phone number - 4 lines of type.

In the Description Area:

- 3 List any six items - imprint up to six standard items and save time.

At the Bottom: (Choose one)

- 5 Your company name - imprint your name as carrier, 1 line of type, or
- 6 Your company name - imprint your name as shipper, 1 line of type.

Additional areas or lines of type, \$18.04(R)



STRAIGHT BILL OF LADING ORIGINAL - NOT NEGOTIABLE

Shipper No. _____
Carrier No. _____
Date _____

(Name of Carrier) (SCAC)

TO: Consignee (On Collect on Delivery shipments, the letters "COD" must appear before consignee's name - or as otherwise provided in Item 430, Sec. 1)
Street _____
Street _____

FROM: Shipper
Street _____
Street _____

Destination Zip Code Origin Zip Code

Vehicle Number _____ U.S. DOT Hazmat Reg. Number _____

Route	No. Shipping Units	HM	Kind of Packaging, Description of Articles, Special Marks and Exceptions	U.N. NUMBER	Weight (Subject to Correction)	RATE	CHARGES

REMIT C.O.D. TO: ADDRESS _____

COD Amt \$ _____

C.O.D. FEE: PREPAID COLLECT \$ _____

TOTAL CHARGES: \$ _____

FREIGHT CHARGES: PREPAID COLLECT \$ _____

SHIPPER PER _____

CARRIER PER _____

EMERGENCY RESPONSE TELEPHONE NUMBER: _____

DATE _____



STRAIGHT BILL OF LADING ORIGINAL - NOT NEGOTIABLE

Shipper No. _____
Carrier No. _____
Date _____

(Name of Carrier) (SCAC)

TO: Consignee (On Collect on Delivery shipments, the letters "COD" must appear before consignee's name - or as otherwise provided in Item 430, Sec. 1)
Street _____
Street _____

FROM: Shipper
Street _____
Street _____

Destination Zip Code Origin Zip Code

Vehicle Number _____ U.S. DOT Hazmat Reg. Number _____

Route	No. Shipping Units	HM	Kind of Packaging, Description of Articles, Special Marks and Exceptions	U.N. NUMBER	Weight (Subject to Correction)	RATE	CHARGES

REMIT C.O.D. TO: ADDRESS _____

COD Amt \$ _____

C.O.D. FEE: PREPAID COLLECT \$ _____

TOTAL CHARGES: \$ _____

FREIGHT CHARGES: PREPAID COLLECT \$ _____

SHIPPER PER _____

CARRIER PER _____

EMERGENCY RESPONSE TELEPHONE NUMBER: _____

DATE _____

A BLCC-604 - Snap-A-Part
Bill of Lading, 8½" x 11"
Imprint area varies by selection.

See Page 71 for pricing.

B BLCC-602, BL-601 - Snap-A-Part
Bill of Lading, 8½" x 7"
Imprint area varies by selection.

A BLCC-604 - Bill of Lading

Cat. No.	Pts.	Wt. per 1000	Carbonless Lot Prices				
			250	500	1000	2000	3000
604-3	3	25#	117.47	184.03	323.80	603.25	887.69
604-4	4	32#	139.52	228.64	412.83	784.52	1,155.70

Available numbered in red on request. (R)
All parts white.

B BLCC-602, BL-601 - Bill of Lading

Cat. No.	Pts.	Wt. per 1000	Carbonless Lot Prices				
			250	500	1000	2000	3000
602-3	3	16#	99.06	148.56	252.36	460.88	669.19
602-4	4	22#	113.83	178.31	311.95	570.49	852.54
BL-		Carbon Lot Prices					
601-3	3	18#	87.83	126.52	208.16	362.80	525.15
601-4	4	25#	97.60	145.44	242.89	440.80	637.88

Numbered by request only. (R)
All parts white.

C BBLCC-620, BBL-621, 321 - Freight Bill/Bill of Lading

Cat. No.	Pts.	Wt. per 1000	Carbonless Lot Prices				
			250	500	1000	2000	3000
620-5	5	21#	126.83	195.05	300.09	570.18	810.32
BBL-		Carbon Lot Prices					
621-5	5	26#	109.56	168.84	294.27	543.66	796.48
321-5*	5	26#	109.56	168.84	294.27	543.66	796.48

*California version not shown. (R)
Numbered by request only.

D PLCC-630 - Packing List

Cat. No.	Pts.	Wt. per 1000	Carbonless Lot Prices				
			250	500	1000	2000	3000
630-2	2	11#	82.94	115.70	187.77	329.94	478.87
630-3	3	16#	99.06	148.56	252.36	460.88	669.19

Envelopes available on page 100. (9907) (R)

E PLE-9430 - Packing List Envelope

Cat. No.	Pts.	Wt. per 1000	Stock Lot Prices			
			500	1000	2000	5000
9430	1	9#	68.17	99.68	176.12	414.08

For use with item D. (R)

NOTE:



Includes your company's name, address and phone number in one of four colors! For blank forms, subtract 30%.

Numbering

Forms will **NOT** be sequentially numbered unless specified otherwise.



Colors correspond to sequence and number of parts selected in your order unless otherwise specified.



C BBLCC-620, BBL-621, 321 - Snap-A-Part Freight Bill/Bill of Lading, 8½" x 5½" Imprint area 1" x 3"

D PLCC-630 - Snap-A-Part Packing List, 8½" x 7" Imprint area ¾" x 4"



E PLE-9430 - Envelope Packing List Envelope, 4½" x 5½"

Use Shipping Labels to make sure address information can be easily seen and read. See page 113 for our extensive selection.

Shipping & Receiving

SHIPPING ORDER 001001

YOUR COMPANY NAME
Address
CITY, STATE, ZIP CODE
Phone Number
Advertising Line

SHIPPER NUMBER

SHIPPED TO: ADDRESS, CITY, STATE, ZIP CODE
DATE SHIPPED: CUSTOMER'S ORDER NUMBER
OUR NUMBER
SHIPPED VIA

QUANTITY ORDERED	QUANTITY SHIPPED	DESCRIPTION

HOW PACKAGED: NO. PACKAGES, WEIGHT, RECD BY

RECEIVED IN GOOD ORDER BY: PREPAID COLLECT

RECEIVED FROM: ADDRESS, CITY, STATE, ZIP CODE, PHONE NUMBER, FREIGHT BILL NO.

REMARKS: CONDITIONS, ETC.

NO. PACKAGES, WEIGHT, RECEIVED BY, CHECKED BY, DELIVERED BY

RECEIVED BY: DATE, PURCHASE ORDER NO. OR RETURNED GOODS

NO. PACKAGES, WEIGHT, RECEIVED BY, CHECKED BY, DELIVERED BY

RECEIVED FROM: ADDRESS, CITY, STATE, ZIP CODE, PHONE NUMBER, FREIGHT BILL NO.

REMARKS: CONDITIONS, ETC.

NO. PACKAGES, WEIGHT, RECEIVED BY, CHECKED BY, DELIVERED BY

RECEIVED BY: DATE, PURCHASE ORDER NO. OR RETURNED GOODS

A SOCC-629, SO-620 - Snap-A-Part
Shipping Order, 8½" x 7"
Imprint area 1" x 3½"

RETURN TO VENDOR 001001

YOUR COMPANY NAME
Address
CITY, STATE, ZIP CODE
Phone Number
Advertising Line

DATE
PURCHASE ORDER NO.
HOW RETURNED: RETURNED TO VENDOR PREPAID COLLECT

OUR ORDER NO.
PERSON AUTHORIZING RETURN
SHIPPED CHARGES

QTY. RETD.	YOUR INVOICE NO.	STOCK NUMBER	DESCRIPTION	UNIT PRICE	TOTAL AMOUNT

REASON FOR RETURN: OVERSTOCK, ORDER MISTAKE, SUBSTITUTION ON P.O., DEFECTIVE DELIVERY

ACTION REQUESTED: REPAIR AND RETURN @ NO CHARGE, REPAIR AND RETN., REPLACE @ NO CHARGE, REISSUE FULL CREDIT, OTHER

SUB-TOTAL, TAX, HANDLING CHARGES, TOTAL

RECEIVED BY: DATE, PURCHASE ORDER NO. OR RETURNED GOODS

B RV-643 - Snap-A-Part
Return to Vendor Form, 8½" x 7"
Imprint area 1" x 3½"

DELIVERY RECEIPT 001001

FROM: YOUR COMPANY NAME
Address
CITY, STATE, ZIP CODE
Phone Number
Advertising Line

DATE, YOUR NO., ORDER NO., SALESPERSON

DELIVERED TO:

QUANTITY	PRODUCT NO.	DESCRIPTION

NO. PACKAGES, WEIGHT, RECEIVED IN GOOD ORDER BY: PREPAID COLLECT

RECEIVED FROM: ADDRESS, CITY, STATE, ZIP CODE, PHONE NUMBER, FREIGHT BILL NO.

REMARKS: CONDITIONS, ETC.

NO. PACKAGES, WEIGHT, RECEIVED BY, CHECKED BY, DELIVERED BY

RECEIVED BY: DATE, PURCHASE ORDER NO. OR RETURNED GOODS

C DRCC-642 - Snap-A-Part
Delivery Receipt, 5½" x 8½"
Imprint area 1" x 3"

RECEIVING FORM 001001

YOUR COMPANY NAME
Address
CITY, STATE, ZIP CODE
Phone Number
Advertising Line

DATE, PURCHASE ORDER NO. OR RETURNED GOODS

RECEIVED FROM: ADDRESS, CITY, STATE, ZIP CODE, PHONE NUMBER, FREIGHT BILL NO.

REMARKS: CONDITIONS, ETC.

NO. PACKAGES, WEIGHT, RECEIVED BY, CHECKED BY, DELIVERED BY

RECEIVED BY: DATE, PURCHASE ORDER NO. OR RETURNED GOODS

D RFCC-641, RF-640 - Snap-A-Part
Receiving Form, 5½" x 8½"
Imprint area 1" x 3"

A SOCC-629, SO-620 - Shipping Order

Cat. No.	Pts.	Wt. per 1000	Carbonless Lot Prices				
			250	500	1000	2000	3000
629-3	3	16#	99.06	148.56	252.36	460.88	669.19
SO-			Carbon Lot Prices				
620-3	3	18#	87.20	124.54	206.70	368.21	531.80

Envelopes available on page 100. (9906)

B RV-643 - Return to Vendor Form

Cat. No.	Pts.	Wt. per 1000	Carbonless Lot Prices				
			250	500	1000	2000	3000
643-3	3	16#	99.06	148.56	252.36	460.88	669.19

Envelopes available on page 100. (9906, 9907)

C DRCC-642 - Delivery Receipt

Cat. No.	Pts.	Wt. per 1000	Carbonless Lot Prices				
			250	500	1000	2000	3000
642-2	2	9#	77.43	105.82	168.32	293.12	415.32
642-3	3	13#	89.91	129.84	215.54	383.19	558.43

(R)

D RFCC-641, RF-640 - Receiving Form

Cat. No.	Pts.	Wt. per 1000	Carbonless Lot Prices				
			250	500	1000	2000	3000
641-3	3	13#	89.91	129.84	215.54	383.19	558.43
RF-			Carbon Lot Prices				
640-3	3	16#	81.17	113.00	181.64	318.29	458.28

(R)

NOTE:



Includes your company's name, address and phone number in one of four colors! For blank forms, subtract 30%.



Colors correspond to sequence and number of parts selected in your order unless otherwise specified.



Choose a six-digit starting number for your imprinted form at no extra charge! Otherwise, we will start with 001001. Four, five and seven-digit numbering available at an additional charge. See page 142 for pricing.

Blank forms will be sequentially numbered unless specified otherwise.

DUPLICATE

DRIVER'S DAILY LOG

- General Instructions for Completing Log
- Sample Log

- Eligible Hours Recaps with Instructions
- Daily Vehicle Condition Report

Meets the requirements of
THE UNITED STATES DEPARTMENT OF TRANSPORTATION

FOR THE MONTH OF _____ YEAR _____

CARRIER _____ DRIVER _____

ADDRESS _____ ADDRESS _____

CITY _____ STATE _____ CITY _____ STATE _____

FINDER --- PLEASE RETURN THIS BOOK TO DRIVER OR CARRIER

Cover

DRIVER'S DAILY LOG ORIGINAL - Fill each day at home terminal
DUPLICATE - Driver retains in his possession for eight days

RECAP

MONTH: _____ (DAY) _____ (YEAR) _____ (TOTAL MILES TODAY) _____ (VEHICLE NUMBERS - Show each unit - Tractors, Trailers, Units, etc.) _____

TOTAL MILES DRIVEN TODAY _____ I certify these entries are true and correct • (DRIVER'S SIGNATURE IN FULL) _____

YOUR COMPANY NAME _____ (NAME OF CARRIER OR CONTRACTOR) _____ (NAME OF COORDINATOR) _____

ADDRESS - CITY, STATE, ZIP CODE _____ (MAIN OFFICE ADDRESS) _____ (HOME TERMINAL ADDRESS) _____

	MID-NIGHT											NOON											TOTAL HOURS
	1	2	3	4	5	6	7	8	9	10	11	1	2	3	4	5	6	7	8	9	10	11	
1: OFF DUTY																							
2: SLEEPER BERTH																							
3: DRIVING																							
4: ON DUTY (NOT DRIVING)																							
REMARKS																							

Shipping documents: Bill of lading/markers numbers: _____ Shipper and commodity: _____
Check the time and error rates of this log, report and other related items from work and other and areas with charges of duty, account, before every hour.

FROM: _____ (STARTING POINT OR PLACE) TO: _____ (DESTINATION OR TURN AROUND POINT OR PLACE)

USE TIME STANDARD AT HOME TERMINAL

Inside Page

DRIVER'S VEHICLE CONDITION / INSPECTION REPORT

COMPLETION OF THIS REPORT REQUIRED BY THE D.O.T. FEDERAL MOTOR CARRIER SAFETY REGULATIONS.

Mileage (No. Tenth)

DATE: _____ Truck or Tractor No. _____ 1st Trailer No. _____
Dolly No. _____ Location: _____ 2nd Trailer No. _____

Check Box That Applies:

There were no defects or deficiencies detected in this motor vehicle that would cause mechanical breakdown or effect the safety of this vehicle's operation.

Defects or deficiencies were detected in this motor vehicle that could cause mechanical breakdown or effect the safety of this vehicle's operation.

Defects or deficiencies were detected on: Truck or Tractor Trailer Please describe in detail below problem area(s) for maintenance repairs.

DRIVER'S SIGNATURE: _____

MAINTENANCE ACTION:
 Repairs Made No Repairs Needed for safe operation of vehicle Date _____
R.O. #'s _____

MECHANIC'S SIGNATURE: _____ DRIVER'S SIGNATURE: _____

Backer

E DDL-143 - Driver's Log Book
Stitch bound with wrap around cover, 8½" x 5½"
Imprint area ½" x 3¼"
31 sets per book, now includes pencil carbon

F DDL-343 - Driver's Log Book (No DVIR Backer)
Stitch bound with wrap around cover, 8½" x 5½"
Imprint area ½" x 3¼"
31 sets per book

E DDL-143 - Driver's Log Book

Cat. No.	Pts.	Wt. per 10 Bks	Carbonless Lot Prices				
			10 Bks	15 Bks	25 Bks	50 Bks	100 Bks
DDL-143-2	2	4#	116.22	165.83	264.11	503.41	973.70

Not available numbered. (R)
Now includes pencil carbon.

F DDL-343 - Driver's Log Book (No DVIR Backer)

Cat. No.	Pts.	Wt. per 10 Bks	Carbonless Lot Prices				
			10 Bks	15 Bks	25 Bks	50 Bks	100 Bks
DDL-343-2	2	4#	113.93	162.60	258.91	493.53	954.67

Not available numbered. (R)

G REQCC-574 - Stock Requisition

Cat. No.	Pts.	Wt. per 1000	Carbonless Lot Prices				
			250	500	1000	2000	3000
REQCC-574-3	3	13#	76.08	103.95	164.16	281.58	404.09

Not available imprinted. (R)
Numbered by request only.

STOCK REQUISITION To Purchasing Dept.

BOOKS NEEDED FOR _____ DATE NEEDED BY _____ DATE _____

SOURCE OF SUPPLY _____

DELIVER TO DEPT. _____ CHANGE TO _____ ACCT. NO. _____

PLEASE ORDER THE FOLLOWING:

QUANTITY	SIZE	DESCRIPTION	AMT. ON HAND	REORDER

KEEP CANARY COPY FOR REFERENCE SEND OTHERS TO PURCHASING

USE SEPARATE SET FOR EACH TYPE OF GOODS

REQCC-574-3 PRINTED IN U.S.A.

REQUESTED BY _____ APPROVED BY _____
ORDERED FROM _____ FILL DATE _____ FAX NO. _____

G REQCC-574 - Snap-A-Part
Stock Requisition Form, 8½" x 5½"





PRINTED WITH SOY INK

YOUR COMPANY NAME
Address
CITY, STATE, ZIP CODE
Phone Number
Advertising Line

INVOICE
001001

DATE:

SOLD TO _____ **SHIPP TO** _____

CUST. ORDER NO.	DATE SHIPPED	SHIPPED VIA	TERMS	SALESMAN	EQUB.	OUR ORDER NO.
QTY. ORDERED	EO	QTY. SHIPPED	DESCRIPTION	UNIT PRICE	AMOUNT	

INVCC-750
PRINTED IN U.S.A.

Thank You

A INVCC-750, INV-751 - Snap-A-Part
Invoice, 8½" x 11"
Imprint area 1" x 4"

View forms in detail at:
www.bfands.com

A INVCC-750, INV-751 - Invoice

Cat. No.	Pts.	Wt. per 1000	Carbonless Lot Prices				
			250	500	1000	2000	3000
INVCC-750-2	2	16#	94.07	137.54	232.18	418.96	606.58
750-3	3	25#	117.47	184.03	323.80	603.25	887.69
750-4	4	32#	139.52	228.64	412.93	784.52	1,155.70

INV-	Pts.	Wt. per 1000	Carbon Lot Prices				
			250	500	1000	2000	3000
751-3	3	29#	100.52	150.75	258.49	469.51	686.56
751-4	4	39#	114.56	179.66	314.76	588.38	860.96
751-5	5	48#	129.84	209.61	374.14	707.15	1,039.64

Envelopes available on page 100. (9907) (R)

B INVCC-753, INV-752 - Invoice

Cat. No.	Pts.	Wt. per 1000	Carbonless Lot Prices				
			250	500	1000	2000	3000
INVCC-753-3	3	20#	104.16	158.44	273.36	502.48	733.67
753-4	4	26#	121.52	192.97	344.60	641.63	941.77

INV-	Pts.	Wt. per 1000	Carbon Lot Prices				
			250	500	1000	2000	3000
752-3	3	22#	91.36	132.65	221.68	398.37	576.63
752-4	4	31#	101.97	154.60	266.29	487.19	709.54

Envelopes available on page 100. (9907) (R)

NOTE:



Includes your company's name, address and phone number in one of four colors! For blank forms, subtract 30%.



Colors correspond to sequence and number of parts selected in your order unless otherwise specified.



Choose a six-digit starting number for your imprinted form at no extra charge! Otherwise, we will start with 001001. Four, five and seven-digit numbering available at an additional charge. See page 142 for pricing.



Blank forms will be sequentially numbered unless specified otherwise.

PRINTED WITH SOY INK

YOUR COMPANY NAME
Address
CITY, STATE, ZIP CODE
Phone Number
Advertising Line

INVOICE
001001

DATE:

SOLD TO _____ **SHIPP TO** _____

CUST. ORDER NO.	DATE SHIPPED	SHIPPED VIA	TERMS	SALESMAN	EQUB.	OUR ORDER NO.
QTY. ORDERED	EO	QTY. SHIPPED	DESCRIPTION	UNIT PRICE	AMOUNT	

INVCC-753
PRINTED IN U.S.A.

Thank You

B INVCC-753, INV-752 - Snap-A-Part
Invoice, 8½" x 8½"
Imprint area 1" x 4"

C **INVCC-755, INV-754 (Ruled),
INVCC-765, INV-764 (Unruled) - Snap-A-Part**
Invoice, 8½" x 7"
Imprint area 1" x 4"

D **INVCC-760 - Snap-A-Part**
Invoice, 8½" x 5½"
Imprint area ¾" x 3"

C **INVCC-755, INV-754, INVCC-765, INV-764 - Invoice**

Cat. No.	Pts.	Wt. per 1000	Carbonless Lot Prices				
			250	500	1000	2000	3000
755-2	2	11#	82.94	115.70	187.77	329.94	478.87
755-3	3	16#	99.06	148.56	252.36	460.88	669.19
755-4	4	22#	113.83	178.31	311.94	570.49	852.54
INV-			Carbon Lot Prices				
754-2	2	12#	77.43	106.55	167.80	291.56	412.93
754-3	3	18#	87.21	124.54	206.70	368.21	531.80
754-4	4	25#	96.88	144.30	245.18	445.80	647.24
INVCC-			Carbonless Lot Prices				
765-2	2	11#	82.94	115.70	187.77	329.94	478.87
765-3	3	16#	99.06	148.56	252.36	460.88	669.19
765-4	4	22#	113.83	178.31	311.94	570.49	852.54
765-5	5	28#	128.28	206.08	366.55	674.91	1,008.85
INV-			Carbon Lot Prices				
764-3	3	18#	87.21	124.54	206.70	368.21	531.80
764-4	4	25#	96.88	144.30	245.18	445.80	647.24
764-5	5	31#	103.33	163.96	283.98	525.98	764.14

Envelopes available on page 100. (9907)

(R)

D **INVCC-760 - Invoice**

Cat. No.	Pts.	Wt. per 1000	Carbonless Lot Prices				
			250	500	1000	2000	3000
760-2	2	9#	77.43	105.82	168.32	293.12	415.22
760-3	3	13#	89.91	122.36	203.16	361.14	526.40
760-4	4	17#	95.63	138.37	228.12	407.84	594.83

Envelopes available on page 100. (9907)

(R)

E **INVCC-767 - Invoice**

Cat. No.	Pts.	Wt. per 1000	Carbonless Lot Prices				
			250	500	1000	2000	3000
767-3	3	16#	99.06	148.56	252.36	460.88	669.19

Envelopes available on page 100. (9907)

(R)

Bi-Lingual

E **INVCC-767 - Snap-A-Part**
Invoice, 8½" x 7"
Imprint area 1" x 4"
Bi-Lingual

NOTE:

! If you need an English/Spanish, Bi-Lingual Invoice, try the **INVCC-767**.

Invoices

A INVCC-782, INV-781 - Snap-A-Part Invoice, 8½" x 7" Imprint area 1" x 3"

Part 4 Packing List with blackout

Part 5 with label for INV-781

B INVCC-759 Snap-A-Part Invoice, 8½" x 11" Imprint area 1" x 4"

C INVCC-758 Snap-A-Part Invoice, 8½" x 8½" Imprint area 1" x 4"

D INVCC-757 Snap-A-Part Invoice, 8½" x 7" Imprint area 1" x 4"

A INVCC-782, INV-781 - Invoice

Cat. No.	Pts.	Wt. per 1000	Carbonless Lot Prices				
			250	500	1000	2000	3000
782-4	4	22#	113.83	178.31	311.95	570.49	852.54
INV-				Carbon Lot Prices			
781-4	4	25#	96.88	144.30	245.18	445.80	647.24
781-5	5	31#	130.26	209.72	374.14	713.08	1,045.15

Envelopes available on page 100. (9911, 9909) (R)

B INVCC-759 - Invoice

Cat. No.	Pts.	Wt. per 1000	Carbonless Lot Prices				
			250	500	1000	2000	3000
759-3	3	25#	117.47	184.03	323.80	603.25	887.69

Envelopes available on page 100. (9907) (R)

C INVCC-758 - Invoice

Cat. No.	Pts.	Wt. per 1000	Carbonless Lot Prices				
			250	500	1000	2000	3000
758-3	3	20#	104.19	158.44	273.36	502.48	733.67
758-4	4	26#	121.52	192.97	344.60	641.63	941.88

Envelopes available on page 100. (9907) (R)

D INVCC-757 - Invoice

Cat. No.	Pts.	Wt. per 1000	Carbonless Lot Prices				
			250	500	1000	2000	3000
757-3	3	16#	99.06	148.56	252.36	460.88	669.19

Envelopes available on page 100. (9907) (R)

NOTE:



Includes your company's name, address and phone number in one of four colors! For blank forms, subtract 30%.



Colors correspond to sequence and number of parts selected in your order unless otherwise specified.



Choose a six-digit starting number for your imprinted form at no extra charge! Otherwise, we will start with 001001. Four, five and seven-digit numbering available at an additional charge. See page 142 for pricing.



Blank forms will be sequentially numbered unless specified otherwise.

**View forms in detail at:
www.bfands.com**

A STCC-679, STCC-689, ST-678, ST-688 - Statement

Cat. No.	STCC-	Pts.	Wt. per 1000	Carbonless Lot Prices				
				250	500	1000	2000	3000
679-2	Unruled	2	8#	79.51	100.62	157.40	271.49	383.40
689-2	Ruled	2	8#	79.51	100.62	157.40	271.49	383.40
689-3	Ruled	3	11#	85.96	120.38	196.82	350.22	501.85
689-4	Ruled	4	14#	92.20	139.52	235.40	427.80	590.98
689-5	Ruled	5	16#	98.33	158.13	272.12	503.46	677.61
ST-		Carbon Lot Prices						
678-2	Unruled	2	9#	77.53	99.06	145.03	243.20	339.09
688-2	Ruled	2	9#	77.53	99.06	145.03	243.20	339.09

Numbered by request only. (R)
Envelopes available on page 101. (9915)

B STCC-687, STCC-677, ST-686 - Statement

Cat. No.	STCC-	Pts.	Wt. per 1000	Carbonless Lot Prices				
				250	500	1000	2000	3000
687-2	Ruled	2	8#	79.51	100.62	157.40	271.49	383.40
677-2	Unruled	2	8#	79.51	100.62	157.40	271.49	383.40
ST-		Carbon Lot Prices						
686-2	Ruled	2	9#	77.53	99.06	145.03	243.20	339.09

Numbered by request only. (R)
Envelopes available on page 101. (9915)

NOTE:

Company Imprint

Includes your company's name, address and phone number in one of four colors! For blank forms, subtract 30%.

Starting Number

Choose a six-digit starting number for your imprinted form at no extra charge! Otherwise, we will start with 001001. Four, five and seven-digit numbering available at an additional charge. See page 142 for pricing.

Blank forms will be sequentially numbered unless specified otherwise.

Multi-part Color Sequence

Colors correspond to sequence and number of parts selected in your order unless otherwise specified.

1 Day Blank Shipping

3 Day Imprint

Color code your collections with Collection Forms (page 79) and Business Reply Envelopes (page 99).

YOUR COMPANY NAME
Address
CITY, STATE, ZIP CODE
Phone Number
Advertising Line

DATE

Detach and Return This Stub With Remittance. Amt. Remitted \$

DATE	CHARGES AND CREDITS	BALANCE

STCC-689-2 PRINTED IN U.S.A. Your Check is Your Receipt Thank You

A STCC-679 (Unruled), STCC-689 (Ruled), ST-678 (Unruled), ST-688 (Ruled) - Snap-A-Part Statement, 5 1/2" x 7" Imprint area 1" x 4"

PRINTED IN U.S.A. PRINTED WITH SOY INK

YOUR COMPANY NAME
Address
CITY, STATE, ZIP CODE
Phone Number
Advertising Line

DATE

DETACH AND MAIL WITH YOUR CHECK. YOUR CANCELLED CHECK IS YOUR RECEIPT.

DATE	DESCRIPTION	CHARGES	CREDITS	BALANCE

Thank You PAID BY CHECK NO. STCC-677-2

B STCC-687 (Ruled), STCC-677 (Unruled), ST-686 (Ruled) - Snap-A-Part Statement, 5 1/2" x 7" Imprint area 1" x 4"

Laser Statements



LS-5730 - Navy
LS-5731 - Hunter Green
LS-5732 - Burgundy (shown)

Laser Statement
 Blank front and back
 8½" x 11"

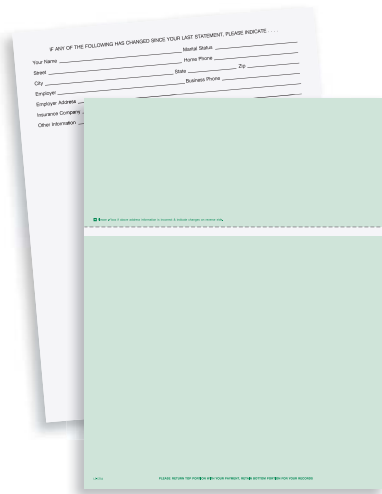

LS-5733 - Navy
LS-5734 - Hunter Green (shown)
LS-5735 - Burgundy

Laser Statement
 Change of address backer
 8½" x 11"

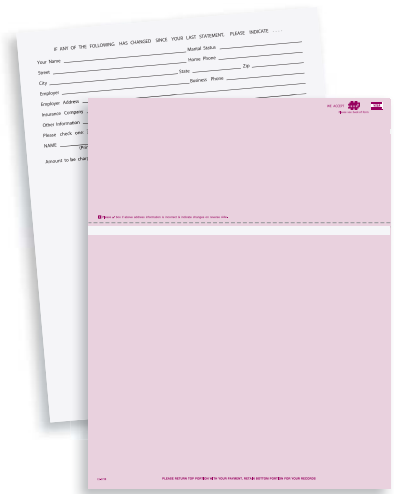

LS-5736 - Navy
LS-5737 - Hunter Green
LS-5738 - Burgundy (shown)

Laser Statement
 Mastercard & Visa on front
 Change of address & credit card
 info on back
 8½" x 11"

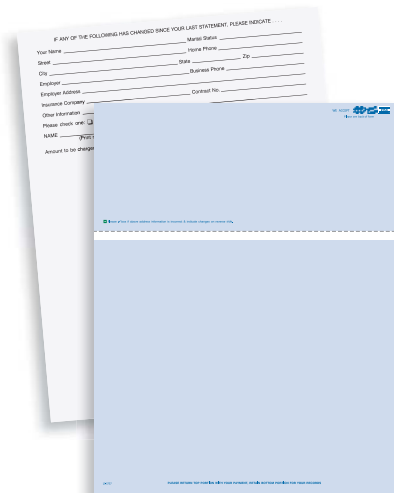

LS-5739 - Navy (shown)
LS-5740 - Hunter Green
LS-5741 - Burgundy

Laser Statement
 Mastercard, Visa & Discover
 on front
 Change of address & credit card
 info on back
 8½" x 11"

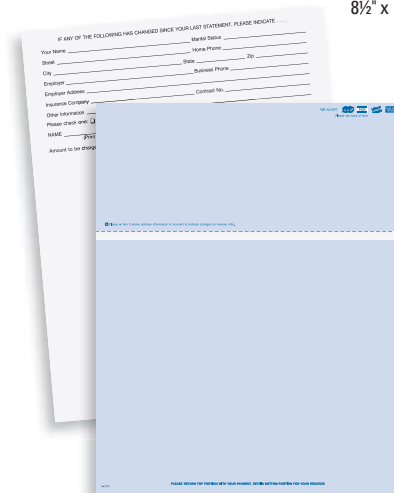

LS-5742 - Navy (shown)
LS-5743 - Hunter Green
LS-5744 - Burgundy

Laser Statement
 Mastercard, Visa, Discover &
 American Express on front
 Change of address & credit card
 info on back
 8½" x 11"

*Statements that
 work with your
 software.*

Laser Statements									
Cat. No.	Color	Backer	Pts.	Wt. per 1000	500	1000	Lot Prices		
LS-					500	1000	2000	3000	5000
5730	Navy	No Backer	1	11#	51.22	72.96	125.06	179.14	283.97
5731	Hunter Green	No Backer	1	11#	51.22	72.96	125.06	179.14	283.97
5732	Burgundy	No Backer	1	11#	51.22	72.96	125.06	179.14	283.97
5733	Navy	Backer	1	11#	51.22	72.96	125.06	179.14	283.97
5734	Hunter Green	Backer	1	11#	51.22	72.96	125.06	179.14	283.97
5735	Burgundy	Backer	1	11#	51.22	72.96	125.06	179.14	283.97
5736	Navy	Backer	1	11#	51.22	72.96	125.06	179.14	283.97
5737	Hunter Green	Backer	1	11#	51.22	72.96	125.06	179.14	283.97
5738	Burgundy	Backer	1	11#	51.22	72.96	125.06	179.14	283.97
5739	Navy	Backer	1	11#	51.22	72.96	125.06	179.14	283.97
5740	Hunter Green	Backer	1	11#	51.22	72.96	125.06	179.14	283.97
5741	Burgundy	Backer	1	11#	51.22	72.96	125.06	179.14	283.97
5742	Navy	Backer	1	11#	51.22	72.96	125.06	179.14	283.97
5743	Hunter Green	Backer	1	11#	51.22	72.96	125.06	179.14	283.97
5744	Burgundy	Backer	1	11#	51.22	72.96	125.06	179.14	283.97

Perforation at 39/16" from top of form.
 Not available imprinted or numbered.
 Envelopes available on page 100. (9910)

(R)

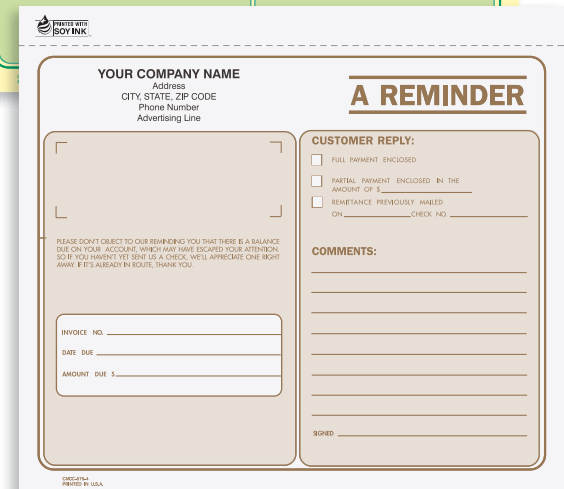
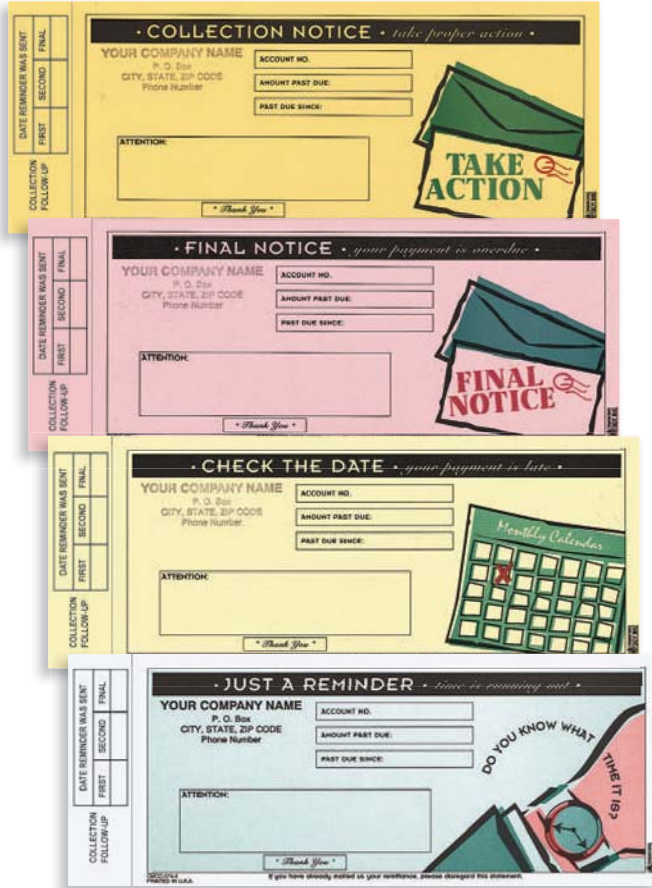

A **CMCC-574 - Snap-A-Part**
Collection Form, 8½" x 3¾"
Imprint area 5½" x 2½"

A **CMCC-574 - Collection Form**

Cat. No.	Pts.	Wt. per 1000	Carbonless Lot Prices				
			250	500	1000	2000	3000
CMCC-574-4	4	12#	78.57	124.44	216.79	389.32	561.55

Not available numbered. (R)
Envelopes available on page 100. (9909)

B **CMCC-575 - Collection Memo**

Cat. No.	Pts.	Wt. per 1000	Carbonless Lot Prices				
			250	500	1000	2000	3000
CMCC-575-4	4	22#	115.08	181.22	317.88	609.49	870.22

Not available numbered. (R)
Envelopes available on page 100. (9909, 9911)

NOTE:



Includes your company's name, address and phone number in one of four colors! For blank forms, subtract 30%.



Colors correspond to sequence and number of parts selected in your order unless otherwise specified.



! Business Reply Envelopes, available in colors to match each consecutive message. See page 99.

Credit/Debit Memos

A DM-577 - Snap-A-Part
Debit Memo, 8½" x 7"
Imprint area 1" x 4"

B DCM-578 - Snap-A-Part
Debit/Credit Memo, 8½" x 7"
Imprint area 1" x 4"

C CMCC-576, CM-579 - Snap-A-Part
Credit Memo, 8½" x 7"
Imprint area 1" x 4"

D CM-235 - Register Form
Credit Memo, 4" x 6½"
Imprint area 1" x 3½"

A DM-577 - Debit Memo

Cat. No.	Pts.	Wt. per 1000	Carbonless Lot Prices				
			250	500	1000	2000	3000
577-3	3	16#	99.06	148.56	252.36	460.88	669.19

Envelopes available on page 100. (9906, 9907) (R)

B DCM-578 - Debit/Credit Memo

Cat. No.	Pts.	Wt. per 1000	Carbonless Lot Prices				
			250	500	1000	2000	3000
578-3	3	16#	99.06	148.56	252.36	460.88	669.19

Envelopes available on page 100. (9906, 9907) (R)

C CMCC-576, CM-579 - Credit Memo

Cat. No.	Pts.	Wt. per 1000	Carbonless Lot Prices				
			250	500	1000	2000	3000
576-3	3	16#	99.06	148.56	252.36	460.88	669.19
CM-			Carbon Lot Prices				
579-3	3	18#	87.20	124.54	206.70	368.21	531.80

All parts pink.
Envelopes available on pages 100. (9909, 9911) (R)

D CM-235 - Credit Memo

Cat. No.	Pts.	Wt. per 1000	Carbonless Lot Prices				
			250	500	1000	2000	3000
235-2*	2	5#	71.60	92.61	125.58	192.97	259.43
235-3*	3	7#	81.17	104.78	149.29	240.60	332.54

*7 digit numbering only. (R)

NOTE:



Company Imprint

Includes your company's name, address and phone number in one of four colors! For blank forms, subtract 30%.



Multi-part Color Sequence

Colors correspond to sequence and number of parts selected in your order unless otherwise specified.



Starting Number

Choose a six-digit starting number for your imprinted form at no extra charge! Otherwise, we will start with 001001. Four, five and seven-digit numbering available at an additional charge. See page 142 for pricing.

Blank forms will be sequentially numbered unless specified otherwise.

A **RMCC-848, RM-858 - Snap-A-Part**
Reply Memo Ruled, 8½" x 7"
Imprint area ¾" x 3½"

B **RMCC-868 - Snap-A-Part**
Reply Memo Unruled, 8½" x 6½"
Imprint area ¾" x 3½"

A **RMCC-848, RM-858 Ruled - Reply Memo**

Cat. No. RMCC-	Pts.	Wt. per 1000	Carbonless Lot Prices				
			250	500	1000	2000	3000
848-2	2	11#	82.94	115.70	187.77	329.94	478.87
848-3	3	16#	99.06	148.56	252.36	460.88	669.19
RM-			Carbon Lot Prices				
858-3	3	18#	87.20	124.54	206.70	368.21	531.80

Envelopes available on page 100. (9906)

(R)

B **RMCC-868, Unruled - Reply Memo**

Cat. No. RMCC-	Pts.	Wt. per 1000	Carbonless Lot Prices				
			250	500	1000	2000	3000
868-3	3	16#	99.06	148.56	252.36	460.88	669.19

Envelopes available on page 100. (9906)

(R)

C **MRM-810 - Message/ Reply Memo**

Cat. No. MRM-	Pts.	Wt. per 1000	Carbonless Lot Prices				
			250	500	1000	2000	3000
810-3	3	16#	99.06	148.56	252.36	460.88	669.19

Envelopes available on page 100. (9909, 9911)

(R)

D **MRM-859 - Message/ Reply Memo**

Cat. No. MRM-	Pts.	Wt. per 1000	Carbon Lot Prices				
			250	500	1000	2000	3000
859-3	3	18#	92.30	124.12	205.04	365.30	529.31

Envelopes available on page 100. (9906)

(R)

NOTE:



! Self-Inking Stamps make your job easier. See page 122

C **MRM-810 - Snap-A-Part**
Message/Reply Memo, 8½" x 6½"
Imprint area ¾" x 3½"

D **MRM-859 - Snap-A-Part**
Message/Reply Memo, 8½" x 6½"
Imprint area ⅞" x 3"

A MLCC-800 - Snap-A-Part
Memo Letter, 8½" x 7¾"
Imprint area 1" x 4"

B MLCC-803 - Snap-A-Part
Memo Letter, 8½" x 7¾"
Imprint area 1" x 4"

C MLCC-802 - Snap-A-Part
Memo Letter, 8½" x 7¾"
Imprint area 1" x 4"

D PM-101 - Wire Bound Book
Phone Memo Book
Each message measures 5¼" x 2¾", 5¼" x 8¼" Overall
150 Messages Per Book

A MLCC-800 - Memo Letter

Cat. No.	Pts.	Wt. per 1000	Carbonless Lot Prices				
			250	500	1000	2000	3000
800-2	2	12#	86.06	125.37	200.04	356.25	510.28

Envelopes available on page 100. (9910, 9911) (R)

B MLCC-803 - Memo Letter

Cat. No.	Pts.	Wt. per 1000	Carbonless Lot Prices				
			250	500	1000	2000	3000
803-2	2	12#	86.06	125.37	200.04	356.25	510.28
803-3	3	17#	99.06	148.56	252.36	460.88	669.19

Envelopes available on page 100. (9910, 9911) (R)

C MLCC-802 - Memo Letter

Cat. No.	Pts.	Wt. per 1000	Carbonless Lot Prices				
			250	500	1000	2000	3000
802-2	2	12#	86.06	125.37	200.04	356.25	510.28

Envelopes available on page 100. (9909, 9911) (R)

D PM-101 - Phone Memo Book

Cat. No.	Pts.	Wt. per 5 Bks	Carbonless Lot Prices				
			5 Bks	10 Bks	15 Bks	25 Bks	50 Bks
101-2	2	4#	59.12	102.91	139.10	229.89	455.05

Not available imprinted. (R)

NOTE:



Includes your company's name, address and phone number in one of four colors! For blank forms, subtract 30%.



Colors correspond to sequence and number of parts selected in your order unless otherwise specified.



Keep your business rolling!

- Premium quality, guaranteed to work efficiently!
- BPA Free and a color coded end of roll for alerting your customers.
- All rolls on 7/16" core.



Thermal Rolls

Cat. No.	Description	Rolls per Pkg	Size	Wt. per Pkg	Price per Roll	Price per Pkg
PR-0023	Paper Roll, 2 Part, NCR	10/Pkg	3" x 90'	5#	1.53/Roll	15.30
BPR-0024	Bond Paper Roll	12/Pkg	2¼" x 120'	3#	.67/Roll	8.04
TPR-0026	Thermal Paper Roll	8/Pkg	3½" x 240'	5#	2.34/Roll	18.72
TPR-0027	Thermal Paper Roll	12/Pkg	2¼" x 55'	2#	.67/Roll	8.04
TPR-0028	Thermal Paper Roll	12/Pkg	2¼" x 85'	2#	.83/Roll	9.96

(R)

**Additional sizes available,
please call!**

Creative Designs at a Great Price!

It's easier than ever to design your checks with our pre-designed checks and vouchers.

STEP 1: Choose from three convenient check formats: Traditional, Personal and Conventional.

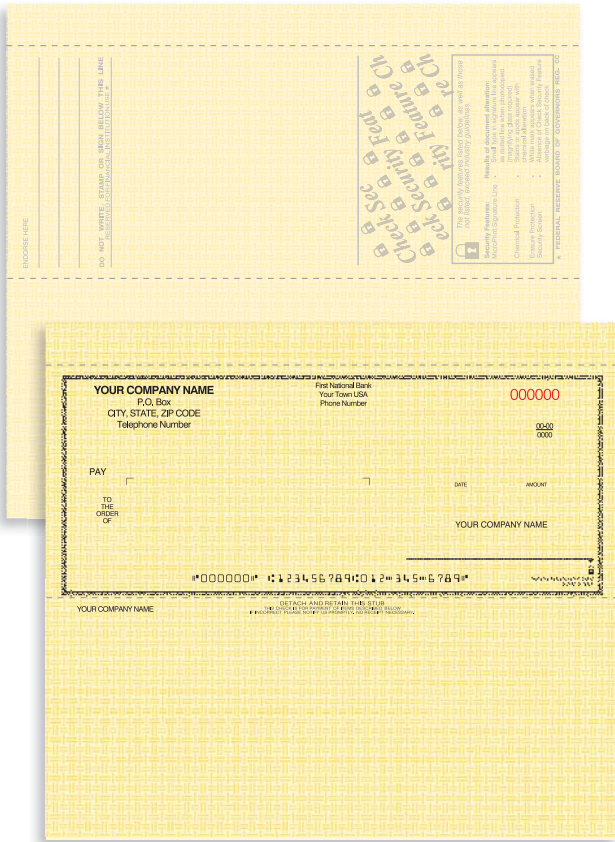

A Check Style 1 - Traditional
8½" x 7"

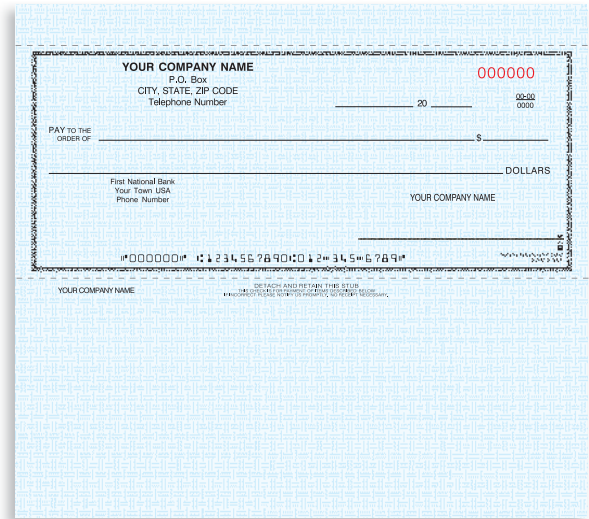

B Check Style 2 - Personal
8½" x 7"

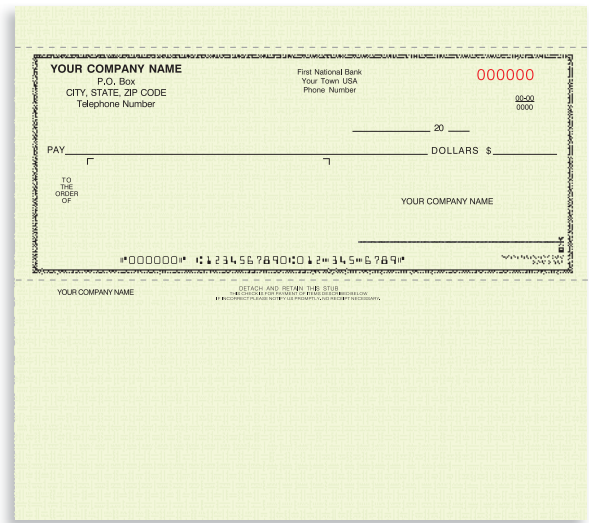

C Check Style 3 - Conventional
8½" x 7"

Parts 2 and 3 are pre-punched on left, making storage of copies convenient.

A Style 1 - Traditional Style Check

Description	Pts.	Wt. per 1000	Carbonless Lot Prices				
			250	500	1000	2000	3000
Check/Voucher	2	15#	108.84	174.25	299.47	552.19	811.46
Check/Voucher	3	21#	125.06	206.70	364.26	681.25	1,005.73

Envelopes available on page 100. (9908) (R)

B Style 2 - Personal Style Check

Description	Pts.	Wt. per 1000	Carbonless Lot Prices				
			250	500	1000	2000	3000
Check/Voucher	2	15#	108.84	174.25	299.47	552.19	811.46
Check/Voucher	3	21#	125.06	206.70	364.26	681.25	1,005.73

Envelopes available on page 100. (9908) (R)

C Style 3 - Conventional Style Check

Description	Pts.	Wt. per 1000	Carbonless Lot Prices				
			250	500	1000	2000	3000
Check/Voucher	2	15#	108.84	174.25	299.47	552.19	811.46
Check/Voucher	3	21#	125.06	206.70	364.26	681.25	1,005.73

Envelopes available on page 100. (9908) (R)

STEP 2: Choose from one of four voucher styles:

- **General or General 2** - Great for applications that require maximum space.
- **Dual Purpose** - Designed for recording payroll or general disbursements.
- **Blank** - Useful when the purpose of the voucher varies.

STEP 3: Choose paper and ink colors.

STEP 4: Choose up to three carbonless parts. All copies are consecutively numbered and "Not Negotiable" is always printed on copies for optimum safety.

YOUR COMPANY NAME

DETACH AND RETAIN THIS STUB
THIS CHECK IS FOR PAYMENT OF THIS DESCRIPTION ONLY.
IF INCORRECT PLEASE NOTIFY US IMMEDIATELY BY TELEPHONE.

DATE	DESCRIPTION	AMOUNT

A Voucher Style 1 - General Purpose

YOUR COMPANY NAME

DETACH AND RETAIN THIS STUB
THIS CHECK IS FOR PAYMENT OF THIS DESCRIPTION ONLY.
IF INCORRECT PLEASE NOTIFY US IMMEDIATELY BY TELEPHONE.

DATE	INVOICE NUMBER	DESCRIPTION	AMOUNT	DEDUCTIONS		NET AMOUNT
				DETAILS	AMOUNT	

B Voucher Style 2 - General 2

YOUR COMPANY NAME

DETACH AND RETAIN THIS STUB
THIS CHECK IS FOR PAYMENT OF THIS DESCRIPTION ONLY.
IF INCORRECT PLEASE NOTIFY US IMMEDIATELY BY TELEPHONE.

DATE	DESCRIPTION	AMOUNT	DISTRIBUTIONS	
			ACCT. NO.	AMOUNT

EMPLOYEE

PERIOD ENDING	EARNINGS				TOTAL EARNINGS	DEDUCTIONS				TOTAL DEDUCTIONS	NET PAY	
	HOURS	RATE	REGULAR EARNINGS	OVERTIME AND OTHER		F.I.C.A.	WITHHOLDING USA/CA/IN	STATE INCOME TAX				

C Voucher Style 3 - Dual Purpose

YOUR COMPANY NAME

DETACH AND RETAIN THIS STUB
THIS CHECK IS FOR PAYMENT OF THIS DESCRIPTION ONLY.
IF INCORRECT PLEASE NOTIFY US IMMEDIATELY BY TELEPHONE.

D Voucher Style 4 - Blank

NOTE:

Safety Paper Colors



When Ordering Checks

Be sure to send a voided check or bank specification sheet to ensure correct MICR encoding.



Starting Number: Choose a six-digit starting number for your imprinted check at no additional charge. Otherwise, we will start at 001001. Four, five and seven-digit numbering is available at an additional charge. See page 142 for pricing.

Blank checks will not be sequentially numbered unless otherwise specified.



Includes your company's name, address and phone number in one of four colors! For blank forms, subtract 30%.



Colors correspond to sequence and number of parts selected in your order unless otherwise specified.



Photocopy and write your present check MICR number in the boxes below or use your bank specification sheet.

43	42	41	40	39	38	37	36	35	34	33	32	31	30	29	28	27	26	25	24	23	22	21	20	19	18	17	16	15	14	13
----	----	----	----	----	----	----	----	----	----	----	----	----	----	----	----	----	----	----	----	----	----	----	----	----	----	----	----	----	----	----

Please note: Any numbers to the left of the numbers within the MICR symbols are not needed to process your order.

A = " " - = " " B = Blank

Create Your Own Design!

STEP 1: Make your paper selection.

STEP 2: Specify color, parts and quantity.

STEP 1: Send us your custom check design.

Full Body Crash Printed!

Sample Check Layout

DATE	DESCRIPTION	INVOICE NO.	AMOUNT	SECOND	DEDUCTIONS	NET AMOUNT

A DFCC - Snap-A-Part
Custom Check, 8½" x 7"

B SFCC - Snap-A-Part
Custom Check, 8½" x 7"

Additional Perf

C SFCC - Snap-A-Part
Voucher Check, 8½" x 7"

A DFCC - Custom Check

Cat. No.	DFCC- Color	Pts.	Wt. per 1000	Carbonless Lot Prices				
				250	500	1000	2000	3000
840-2	Blue	2	15#	137.23	213.98	362.49	661.70	967.67
840-3	Blue	3	21#	147.00	236.13	409.29	757.38	1,112.02
841-2	Brown	2	15#	137.23	213.98	362.49	661.70	967.67
841-3	Brown	3	21#	147.00	236.13	409.29	757.38	1,112.02
842-2	Green	2	15#	137.23	213.98	362.49	661.70	967.67
842-3	Green	3	21#	147.00	236.13	409.29	757.38	1,112.02
843-2	Gray	2	15#	137.23	213.98	362.49	661.70	967.67
843-3	Gray	3	21#	147.00	236.13	409.29	757.38	1,112.02

Envelopes available on page 100. (9908)

(R)

B SFCC - Custom Check

Cat. No.	SFCC- Color	Pts.	Wt. per 1000	Carbonless Lot Prices				
				250	500	1000	2000	3000
740-2	Blue	2	15#	137.23	213.98	362.49	661.70	967.67
740-3	Blue	3	21#	147.00	236.13	409.29	757.38	1,112.02
741-2	Buff	2	15#	137.23	213.98	362.49	661.70	967.67
741-3	Buff	3	21#	147.00	236.13	409.29	757.38	1,112.02
742-2	Green	2	15#	137.23	213.98	362.49	661.70	967.67
742-3	Green	3	21#	147.00	236.13	409.29	757.38	1,112.02

Envelopes available on page 100. (9908)

(R)

C SFCC - Voucher Check

Cat. No.	SFCC- Color	Pts.	Wt. per 1000	Carbonless Lot Prices				
				250	500	1000	2000	3000
745-3	Blue	3	21#	147.00	236.13	409.29	757.38	1,112.02
746-2	Buff	2	15#	137.23	213.98	362.49	661.70	967.67
746-3	Buff	3	21#	147.00	236.13	409.29	757.38	1,112.02
747-2	Green	2	15#	137.23	213.98	362.49	661.70	967.67
747-3	Green	3	21#	147.00	236.13	409.29	757.38	1,112.02

Envelopes available on page 100. (9908)

(R)

NOTE:

Screened Background Colors (Item A)



Safety Paper Colors (Items B & C)



Security Features (Items B & C)

- Padlock Warning Box lists details of features.
- Defensa[®] paper with a true watermark allows anyone to verify the check's authenticity.
- Intricate background provides erasure protection.
- Microprint border and signature line are readable under simple magnification and become a solid line when photocopied or scanned.

Blank checks will not be sequentially numbered unless otherwise specified. Be sure to send a voided check or bank specification sheet to insure correct MICR encoding.

A SCCC - Accounts Payable Security Check

Cat. No.	Color	Pts.	Wt. per 1000	Carbonless Lot Prices				
				250	500	1000	2000	3000
Screened Background Colors								
380-2	Blue	2	15#	114.24	184.03	250.69	473.77	697.06
380-3	Blue	3	21#	131.30	217.10	373.00	584.84	292.71
381-2	Red	2	15#	114.24	184.03	250.69	473.77	697.06
381-3	Red	3	21#	131.30	217.10	373.00	584.84	292.71
382-2	Green	2	15#	114.24	184.03	250.69	473.77	697.06
382-3	Green	3	21#	131.30	217.10	373.00	584.84	292.71
383-2	Brown	2	15#	114.24	184.03	250.69	473.77	697.06
383-3	Brown	3	21#	131.30	217.10	373.00	584.84	292.71
384-2	Gray	2	15#	114.24	184.03	250.69	473.77	697.06
384-3	Gray	3	21#	131.30	217.10	373.00	584.84	292.71
Marble Background Colors								
480-2	Blue	2	15#	114.24	184.03	250.69	473.77	697.06
480-3	Blue	3	21#	131.30	217.10	373.00	584.84	292.71
481-2	Red	2	15#	114.24	184.03	250.69	473.77	697.06
481-3	Red	3	21#	131.30	217.10	373.00	584.84	292.71
482-2	Green	2	15#	114.24	184.03	250.69	473.77	697.06
482-3	Green	3	21#	131.30	217.10	373.00	584.84	292.71
483-3	Brown	3	21#	131.30	217.10	373.00	584.84	292.71
484-3	Gray	3	21#	131.30	217.10	373.00	584.84	292.71

Parts 2 and 3 are punched on left.
Envelopes available on page 100. (9908)

(R)

B DCCC - Dual Purpose Security Check

Cat. No.	Color	Pts.	Wt. per 1000	Carbonless Lot Prices				
				250	500	1000	2000	3000
Screened Background Colors								
390-2	Blue	2	15#	114.24	184.03	250.69	473.77	697.06
390-3	Blue	3	21#	131.30	217.10	373.00	584.84	292.71
392-2	Green	2	15#	114.24	184.03	250.69	473.77	697.06
392-3	Green	3	21#	131.30	217.10	373.00	584.84	292.71
393-3	Brown	3	21#	131.30	217.10	373.00	584.84	292.71
394-2	Gray	2	15#	114.24	184.03	250.69	473.77	697.06
394-3	Gray	3	21#	131.30	217.10	373.00	584.84	292.71
Marble Background Colors								
470-2	Blue	2	15#	114.24	184.03	250.69	473.77	697.06
470-3	Blue	3	21#	131.30	217.10	373.00	584.84	292.71
472-2	Green	2	15#	114.24	184.03	250.69	473.77	697.06
472-3	Green	3	21#	131.30	217.10	373.00	584.84	292.71
473-2	Brown	2	15#	114.24	184.03	250.69	473.77	697.06

Parts 2 and 3 are punched on left.
Envelopes available on page 100. (9908)

(R)

NOTE:



Company Imprint

Includes your company's name, address and phone number in one of four colors! For blank forms, subtract 30%.



Check Numbering

Starting Number: Choose a six-digit starting number for your imprinted check at no additional charge. Otherwise, we will start at 001001. Four, five and seven-digit numbering is available at an additional charge. See page 142 for pricing.

Blank checks will not be sequentially numbered unless otherwise specified.



Multi-part Color Sequence

Colors correspond to sequence and number of parts selected in your order unless otherwise specified.



3 Day Shipping

SECURITY



Items A & B include a Padlock Warning Box, which lists details of security features.



Microprint border and signature line are readable under simple magnification. On copies, microprinting is virtually unreadable. Signature line becomes a broken line when altered (Available on Security Checks only).

A SCCC - Snap-A-Part Accounts Payable Security Check, 8 1/2" x 7" Imprint area 3/4" x 4"

DATE	DESCRIPTION	INVOICE NO.	AMOUNT	CHECK NO.	DEDUCTIONS	NET AMOUNT

B DCCC - Snap-A-Part Dual Purpose Security Check, 8 1/2" x 7" Imprint area 3/4" x 4"

YOUR COMPANY NAME
P.O. Box
CITY, STATE, ZIP CODE
Telephone Number

First National Bank
Your Town USA
Phone Number

0000 0000 000000

DATE

DOLLARS \$

PAY TO THE ORDER OF YOUR COMPANY NAME

AUTHORIZED SIGNATURE

000000 42345678900123456789*

DATE	DESCRIPTION	REFERENCE	AMOUNT	DEBIT	CREDIT	NET DEBIT

000000000000 YOUR COMPANY NAME

A **SCCC, SC - Snap-A-Part**
Accounts Payable Check, 8½" x 7"
Imprint area ¾" x 4"

VOUCHER CHECK

YOUR COMPANY NAME
P.O. Box
CITY, STATE, ZIP CODE
Telephone Number

First National Bank
Your Town USA
Phone Number

0000 0000 000000

DATE

DOLLARS \$

PAY TO THE ORDER OF YOUR COMPANY NAME

AUTHORIZED SIGNATURE

000000 42345678900123456789*

DATE	DESCRIPTION	REFERENCE	AMOUNT	DEBIT	CREDIT	NET DEBIT

000000000000 YOUR COMPANY NAME

B **DCB, DCG - Snap-A-Part**
Dual Purpose Voucher Check, 8½" x 7"
Imprint area ¾" x 4"

YOUR COMPANY NAME
P.O. Box
CITY, STATE, ZIP CODE
Telephone Number

First National Bank
Your Town USA
Phone Number

0000 0000 000000

DATE

DOLLARS \$

PAY TO THE ORDER OF YOUR COMPANY NAME

AUTHORIZED SIGNATURE

000000 42345678900123456789*

DATE	DESCRIPTION	REFERENCE	AMOUNT	DEBIT	CREDIT	NET DEBIT

000000000000 YOUR COMPANY NAME

C **DCCC, DC - Snap-A-Part**
Dual Purpose Check, 8½" x 7"
Imprint area ¾" x 4"

A **SCCC, SC - Accounts Payable Check**

Cat. No.	SCCC- Color	Pts.	Wt. per 1000	Carbonless Lot Prices				
				250	500	1000	2000	3000
627-2	Blue	2	15#	108.84	175.81	295.00	451.52	664.30
627-3	Blue	3	21#	125.16	206.91	355.43	557.39	820.20
619-2	Red	2	15#	108.84	175.81	295.00	451.52	664.30
619-3	Red	3	21#	125.16	206.91	355.43	557.39	820.20
617-2	Green	2	15#	108.84	175.81	295.00	451.52	664.30
617-3	Green	3	21#	125.16	206.91	355.43	557.39	820.20
616-2	Brown	2	15#	108.84	175.81	295.00	451.52	664.30
616-3	Brown	3	21#	125.16	206.91	355.43	557.39	820.20
618-2	Gray	2	15#	108.84	175.81	295.00	451.52	664.30
618-3	Gray	3	21#	125.16	206.91	355.43	557.39	820.20
SC-		Carbon Lot Prices						
607-3	Blue	3	23#	118.09	192.45	340.65	634.87	934.08
609-3	Red	3	23#	118.09	192.45	340.65	634.87	934.08
611-3	Brown	3	23#	118.09	192.45	340.65	634.87	934.08
614-3	Green	3	23#	118.09	192.45	340.65	634.87	934.08
608-3	Gray	3	23#	118.09	192.45	340.65	634.87	934.08

Parts 2 and 3 are punched on left. (R)
Envelopes available on page 100. (9908)

B **DCB, DCG - Dual Purpose Voucher Check**

Cat. No.	DCB- Color	Pts.	Wt. per 1000	Carbon Lot Prices				
				250	500	1000	2000	3000
612-3	Blue	3	23#	119.65	196.40	346.27	651.82	959.87
DCG-		Carbon Lot Prices						
613-3	Gold	3	23#	119.65	196.40	346.27	651.82	959.87

Parts 2 and 3 are punched on left. (R)
Envelopes available on page 100. (9908)

C **DCCC, DC - Dual Purpose Check**

Cat. No.	DCCC- Color	Pts.	Wt. per 1000	Carbonless Lot Prices				
				250	500	1000	2000	3000
615-2	Blue	2	15#	108.84	175.81	295.00	451.52	664.30
615-3	Blue	3	21#	125.16	206.91	355.43	557.39	820.20
622-2	Red	2	15#	108.84	175.81	295.00	451.52	664.30
622-3	Red	3	21#	125.16	206.91	355.43	557.39	820.20
626-2	Green	2	15#	108.84	175.81	295.00	451.52	664.30
626-3	Green	3	21#	125.16	206.91	355.43	557.39	820.20
623-2	Brown	2	15#	108.84	175.81	295.00	451.52	664.30
623-3	Brown	3	21#	125.16	206.91	355.43	557.39	820.20
628-3	Gray	3	21#	125.16	206.91	355.43	557.39	820.20
DC-		Carbon Lot Prices						
610-3	Blue	3	23#	118.09	192.45	340.65	634.87	934.08

Parts 2 and 3 are punched on left. (R)
Envelopes available on page 100. (9908)

NOTE:

When Ordering Checks

Be sure to send a voided check or bank specification sheet to ensure correct MICR encoding.

Marble or Screened Background Colors

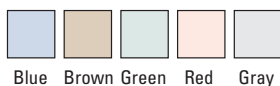

Starting Number: Choose a six-digit starting number for your imprinted check at no additional charge. Otherwise, we will start at 001001. Four, five and seven-digit numbering is available at an additional charge. See page 142 for pricing.

Blank checks will not be sequentially numbered unless otherwise specified.



Includes your company's name, address and phone number in one of four colors! For blank forms, subtract 30%.



Colors correspond to sequence and number of parts selected in your order unless otherwise specified.



D DFC-144, 145, 121, 122, 123 - General Expense Checks

Cat. No.	Color	Pts.	Wt. per 2 Bks	Carbonless Lot Prices		
				1(300)	2(600)	3(900)
144-1	Green	1	5#	63.08	105.20	154.60
145-1	Blue	1	5#	63.08	105.20	154.60
121-1	Yellow	1	5#	63.08	105.20	154.60
122-1	Brown	1	5#	63.08	105.20	154.60
123-1	Red	1	5#	63.08	105.20	154.60
DFC-				2(300)	4(600)	6(900)
144-2	Green	2	9#	129.64	230.00	324.84
145-2	Blue	2	9#	129.64	230.00	324.84
121-2	Yellow	2	9#	129.64	230.00	324.84
122-2	Brown	2	9#	129.64	230.00	324.84
123-2	Red	2	9#	129.64	230.00	324.84

Available in black ink only. (R)
Envelopes available on page 100. (9910)

E DFC-147, 148, 125, 126, 127 - Payroll Checks

Cat. No.	Color	Pts.	Wt. per 2 Bks	Carbonless Lot Prices		
				1(300)	2(600)	3(900)
147-1	Green	1	5#	63.08	105.20	154.60
148-1	Blue	1	5#	63.08	105.20	154.60
125-1	Yellow	1	5#	63.08	105.20	154.60
126-1	Brown	1	5#	63.08	105.20	154.60
127-1	Red	1	5#	63.08	105.20	154.60
DFC-				2(300)	4(600)	6(900)
147-2	Green	2	9#	129.64	230.00	324.84
148-2	Blue	2	9#	129.64	230.00	324.84
125-2	Yellow	2	9#	129.64	230.00	324.84

Available in black ink only. (R)
Envelopes available on page 100. (9910)

NOTE:

When Ordering Checks

Be sure to send a voided check or bank specification sheet to ensure correct MICR encoding.

Screened Background Colors



Blue Brown Green Red Yellow



Check Numbering
Starting Number: Choose a six-digit starting number for your imprinted check at no additional charge. Otherwise, we will start at 001001. Four, five and seven-digit numbering is available at an additional charge. See page 142 for pricing.

Blank checks will not be sequentially numbered unless otherwise specified.



Colors correspond to sequence and number of parts selected in your order unless otherwise specified.

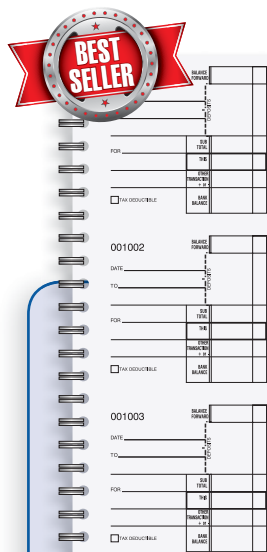

D DFC-144, 145, 121, 122, 123 - Wire Bound

General Expense Checks, 8½" x 3½"
13" x 11" Overall
2-Part - 150 Checks/50 Sheet Sets
1-Part - 300 Checks/100 Sheets

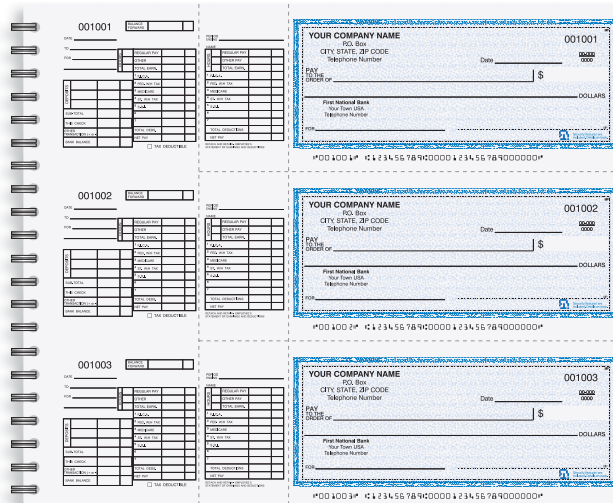

E DFC-147, 148, 125, 126, 127 - Wire Bound

Payroll Checks, 7¼" x 3½"
13" x 11" Overall
2-Part - 150 Checks/50 Sheet Sets
1-Part - 300 Checks/100 Sheets

Photocopy and write your present check MICR number in the boxes below or use your bank specification sheet.

43	42	41	40	39	38	37	36	35	34	33	32	31	30	29	28	27	26	25	24	23	22	21	20	19	18	17	16	15	14	13
----	----	----	----	----	----	----	----	----	----	----	----	----	----	----	----	----	----	----	----	----	----	----	----	----	----	----	----	----	----	----

Please note: Any numbers to the left of the numbers within the ■ symbols are not needed to process your order.

A = ■ - = ■ B = Blank

Smaller Size

New Colors!

A DFC-104, 186, 187 - 3-Ring Binder Checks
 Payroll Checks, 7¼" x 3"
 13" x 9" Overall
 2-Part - 300 Checks/100 Sheet Sets
 1-Part - 300 Checks/100 Sheets

B DFC-054, 046, 045 - 3-Ring Binder Checks
 General Expense Checks, 8¼" x 3"
 13" x 9" Overall
 2-Part - 300 Checks/100 Sheet Sets
 1-Part - 300 Checks/100 Sheets

Convenience for Office or Away

New print technology now provides improved print quality.
 Choose from selections on pages 90 and 91:

- Two General Expense formats (8¼" x 3" or 8½" x 3⅔"), which contain a large stub area for ease in recording your payment details.
- The more compact Payroll/General Expense formats (7¼" x 3" or 7⅛" x 3⅔"), which include one or two stubs for easy record keeping.

Every check order includes 45 free deposit slips.
A second microprint signature line is available upon request.

A DFC-104, 186, 187 - Payroll Checks

Cat. No.	DFC-Color	Pts.	Wt. per 300	Lot Prices		
				300	600	900
104-1	Green	1	5#	54.76	92.92	136.29
186-1	Blue	1	5#	54.76	92.92	136.29
187-1	Red	1	5#	54.76	92.92	136.29
DFC-		Carbonless Lot Prices				
104-2	Green	2	9#	113.00	204.31	288.34
186-2	Blue	2	9#	113.00	204.31	288.34
187-2	Red	2	9#	113.00	204.31	288.34

Available in black ink only. (R)
 Envelopes available on page 100. (9906)

B DFC-054, 046, 045 - General Expense Checks

Cat. No.	DFC-Color	Pts.	Wt. per 300	Lot Prices		
				300	600	900
054-1	Green	1	5#	54.76	92.92	136.29
046-1	Blue	1	5#	54.76	92.92	136.29
045-1	Red	1	5#	54.76	92.92	136.29
DFC-		Carbonless Lot Prices				
054-2	Green	2	9#	113.00	204.31	288.34
046-2	Blue	2	9#	113.00	204.31	288.34
045-2	Red	2	9#	113.00	204.31	288.34

Available in black ink only. (R)
 Envelopes available on page 100. (9906)

C DFC-142, 143, 136, 137, 174, 175, 176 - General Expense Checks

Cat. No.	DFC-	Color	Pts.	Wt. per 300	Lot Prices		
					300	600	900
142-1	Green	1	5#	54.76	92.92	136.29	
143-1	Blue	1	5#	54.76	92.92	136.29	
174-1	Yellow	1	5#	54.76	92.92	136.29	
175-1	Brown	1	5#	54.76	92.92	136.29	
176-1	Red	1	5#	54.76	92.92	136.29	
DFC-					Carbonless Lot Prices		
136-2	Green	2	9#	113.00	204.31	288.34	
137-2	Blue	2	9#	113.00	204.31	288.34	
174-2	Yellow	2	9#	113.00	204.31	288.34	
175-2	Brown	2	9#	113.00	204.31	288.34	
176-2	Red	2	9#	113.00	204.31	288.34	

Available in black ink only. (R)
Envelopes available on page 100. (9910)

D DFC-138, 139, 134, 135, 182, 183, 184 - Payroll Checks

Cat. No.	DFC-	Color	Pts.	Wt. per 300	Lot Prices		
					300	600	900
138-1	Green	1	5#	54.76	92.92	136.29	
139-1	Blue	1	5#	54.76	92.92	136.29	
182-1	Yellow	1	5#	54.76	92.92	136.29	
183-1	Brown	1	5#	54.76	92.92	136.29	
184-1	Red	1	5#	54.76	92.92	136.29	
DFC-					Carbonless Lot Prices		
134-2	Green	2	9#	113.00	204.31	288.34	
135-2	Blue	2	9#	113.00	204.31	288.34	
182-2	Yellow	2	9#	113.00	204.31	288.34	

Available in black ink only. (R)
Envelopes available on page 100. (9910)

NOTE:

When Ordering Checks

Be sure to send a voided check or bank specification sheet to ensure correct MICR encoding.

Screened Background Colors



Blue Brown Green Red Yellow



Starting Number: Choose a six-digit starting number for your imprinted check at no additional charge. Otherwise, we will start at 001001. Four, five and seven-digit numbering is available at an additional charge. See page 142 for pricing.

Blank checks will not be sequentially numbered unless otherwise specified.



Colors correspond to sequence and number of parts selected in your order unless otherwise specified.

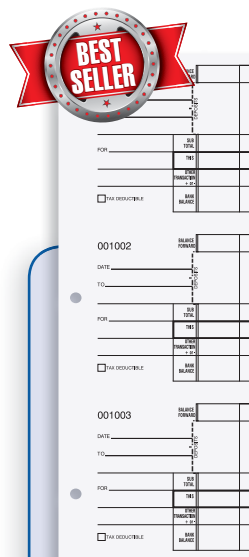

C DFC-142, 143, 136, 137, 174, 175, 176 - 3-Ring Binder Checks

General Expense Checks, 8½" x 3½"
13" x 11" Overall
2-Part - 300 Checks/100 Sheet Sets
1-Part - 300 Checks/100 Sheets

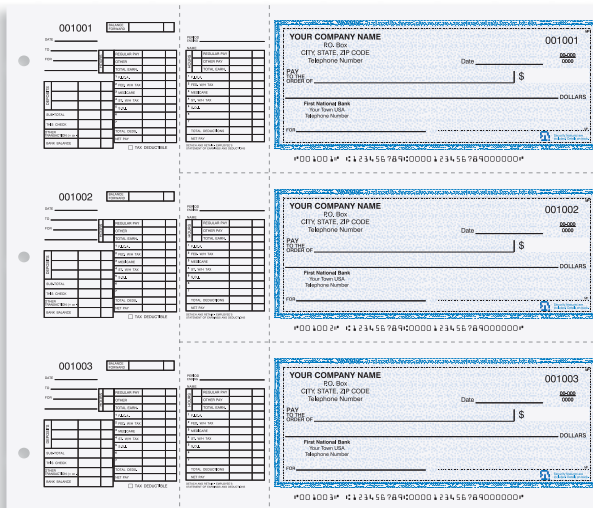

D DFC-138, 139, 134, 135, 182, 183, 184 - 3-Ring Binder Checks

Payroll Checks, 7½" x 3½"
13" x 11" Overall
2-Part - 300 Checks/100 Sheet Sets
1-Part - 300 Checks/100 Sheets

See page 95 for 3-Ring Binders

Photocopy and write your present check MICR number in the boxes below or use your bank specification sheet.

43	42	41	40	39	38	37	36	35	34	33	32	31	30	29	28	27	26	25	24	23	22	21	20	19	18	17	16	15	14	13
----	----	----	----	----	----	----	----	----	----	----	----	----	----	----	----	----	----	----	----	----	----	----	----	----	----	----	----	----	----	----

Please note: Any numbers to the left of the numbers within the ■ symbols are not needed to process your order.

A = ■ - = ■ B = Blank

Checks & Deposit Tickets



High Security Features

Chemical Reactive Box, Chemical Reactive Paper, Microprint Endorsement Lines, Warning Band Diagonal Dimensional Backer, Invisible Embedded Fibers, Thermochromic Icon and Padlock Icon

- A LC-5770, 5771, 5772**
 General Purpose Laser Check, 8½" x 11" Overall
 Top Position
 Imprint area 1½" x 3¼"
 Corresponding Envelope 9854, 9855

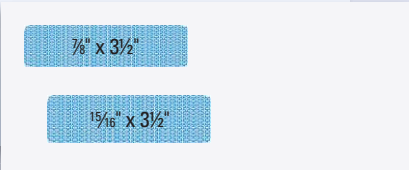
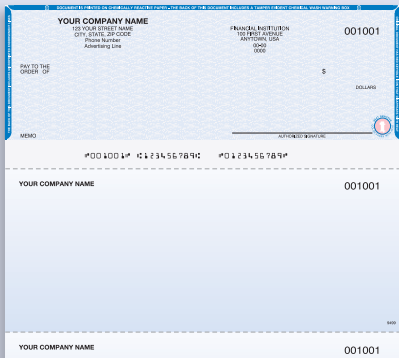

- B ENV-9854, 9855**

- C LC-5776, 5777, 5778**
 General Purpose Laser Check, 8½" x 11" Overall
 Center Position
 Imprint area 1½" x 3¼"
 Corresponding Envelope 9856, 9857

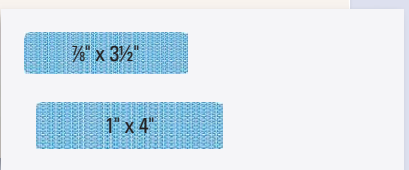
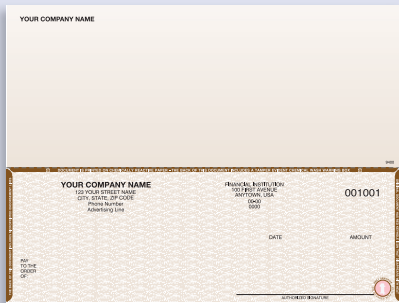

- D ENV-9856, 9857**

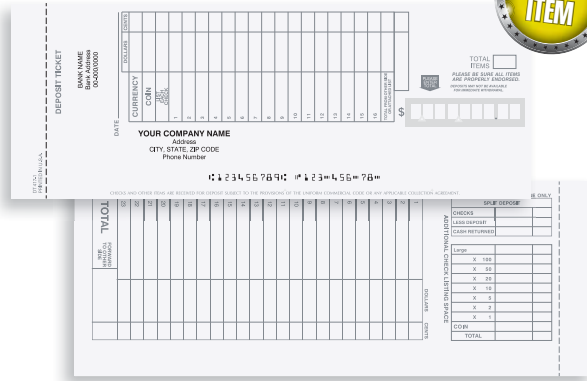

- E DT-417 Booked**
 Deposit Ticket, 8½" x 3½"
 Imprint area 5/8" x 4"
 1 pt - 100 deposit ticket/sheets per book
 39 lines total: 16 front, 23 back
 2 pt - 50 sets per book
 3 pt - 50 sets per book
 17 lines front for multi-part

A LC-5770, 5771, 5772 - General Purpose Laser Checks

Cat. No.	LC- Colors	Pts.	Wt. per 1M	Lot Prices				
				250	500	1000	2000	3000
5770	Blue	1	11#	73.53	94.57	129.58	227.34	264.76
5771	Green	1	11#	73.53	94.57	129.58	227.34	264.76
5772	Brown	1	11#	73.53	94.57	129.58	227.34	264.76

(R)

B ENV-9854, 9855 - Double Window Envelopes (Corresponds with Checks 5770-5772)

Cat. No.	ENV- Type	Size	Wt. per 500	Lot Prices				
				500	1000	2000	3000	5000
9854	Gummed	3¾" x 8¾"	7#	42.05	75.45	148.25	215.45	340.35
9855	Self Seal	3¾" x 8¾"	7#	51.15	90.85	177.45	260.65	416.05

Not available imprinted.

(R)

C LC-5776, 5777, 5778 - General Purpose Laser Checks

Cat. No.	LC- Colors	Pts.	Wt. per 1M	Lot Prices				
				250	500	1000	2000	3000
5776	Blue	1	11#	73.53	94.57	129.58	227.34	264.76
5777	Green	1	11#	73.53	94.57	129.58	227.34	264.76
5778	Brown	1	11#	73.53	94.57	129.58	227.34	264.76

(R)

D ENV-9856, 9857 - Double Window Envelopes (Corresponds with Checks 5776-5778)

Cat. No.	ENV- Type	Size	Wt. per 500	Lot Prices				
				500	1000	2000	3000	5000
9856	Gummed	3¾" x 8¾"	7#	42.05	75.45	148.25	215.45	340.35
9857	Self Seal	3¾" x 8¾"	7#	51.15	90.85	177.45	260.65	416.05

Not available imprinted.

(R)

E DT-417 - Deposit Ticket

Cat. No.	DT- Pts.	Wt. per 2 Bks	Carbonless Lot Prices		
			2 Bks	4 Bks	6 Bks
417-1	1	2#	34.82	51.98	84.13
Carbonless Lot Prices					
417-2	2	2#	59.44	77.22	102.49
417-3	3	3#	69.52	90.22	120.38

Available in black ink only.
 Not available numbered.

(R)

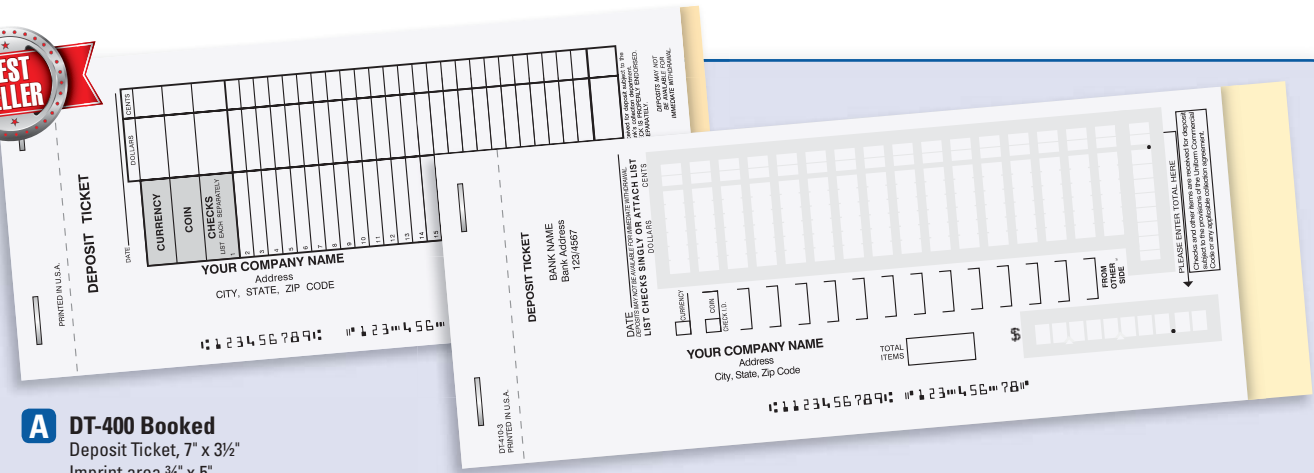

A DT-400 Booked
Deposit Ticket, 7" x 3½"
Imprint area ¾" x 5"
50 sets per book

B DT-410 Booked
Deposit Ticket, 8½" x 3½"
Imprint area ¾" x 2"
50 sets per book

A DT-400 - Deposit Ticket

Cat. No.	Dt.	Pts.	Wt. per 2 Bks	Carbonless Lot Prices		
				2 Bks	4 Bks	6 Bks
400-2	2	2#	2#	59.44	77.22	102.49
400-3	3	3#	3#	69.52	90.22	120.38

Available in black ink only. (R)
Not available numbered.

B DT-410 - Deposit Ticket

Cat. No.	Dt.	Pts.	Wt. per 2 Bks	Carbonless Lot Prices		
				2 Bks	4 Bks	6 Bks
410-2	2	2#	2#	59.44	77.22	102.49
410-3	3	3#	3#	69.52	90.22	120.38

Available in black ink only. (R)
Not available numbered.

C DT-411 - Deposit Ticket

Cat. No.	Dt.	Pts.	Wt. per 2 Bks	Carbonless Lot Prices		
				2 Bks	4 Bks	6 Bks
411-2	2	2#	2#	59.44	77.22	102.49
411-3	3	3#	3#	69.52	90.22	120.38

Available in black ink only. (R)
Not available numbered.

D DT-412 - Deposit Ticket

Cat. No.	Dt.	Pts.	Wt. per 2 Bks	Carbonless Lot Prices		
				2 Bks	4 Bks	6 Bks
412-2	2	2#	2#	59.44	77.22	102.49
412-3	3	3#	3#	69.52	90.22	120.38

Available in black ink only. (R)
Not available numbered.

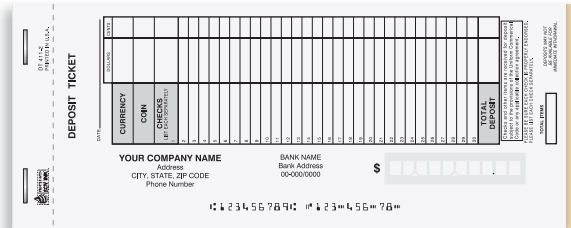

C DT-411 Booked
Deposit Ticket, 8" x 3½"
Imprint area ¾" x 4"
50 sets per book

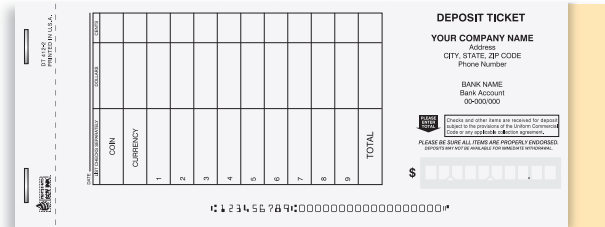

D DT-412 Booked
Deposit Ticket, 8" x 3½"
Imprint area 1¼" x 2½"
50 sets per book

NOTE:

When Ordering Deposit Tickets

Be sure to send a deposit ticket or bank specification sheet to ensure correct MICR encoding.



Colors correspond to sequence and number of parts selected in your order unless otherwise specified.

Photocopy and write your present check MICR number in the boxes below or use your bank specification sheet.

43	42	41	40	39	38	37	36	35	34	33	32	31	30	29	28	27	26	25	24	23	22	21	20	19	18	17	16	15	14	13
----	----	----	----	----	----	----	----	----	----	----	----	----	----	----	----	----	----	----	----	----	----	----	----	----	----	----	----	----	----	----

Please note: Any numbers to the left of the numbers within the ■ symbols are not needed to process your order.

A = ■ - = ■ B = Blank

Deposit Tickets

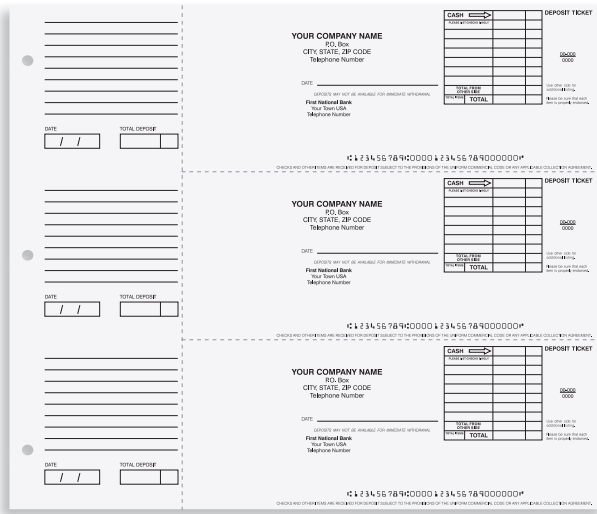

A **DT-413 - 3-Ring Deposit Tickets**
General Expense Deposit Tickets, 8 $\frac{1}{2}$ " x 3 $\frac{3}{8}$ "
13" x 11" Overall
1-Part – 300 Deposit Tickets/100 Sheets

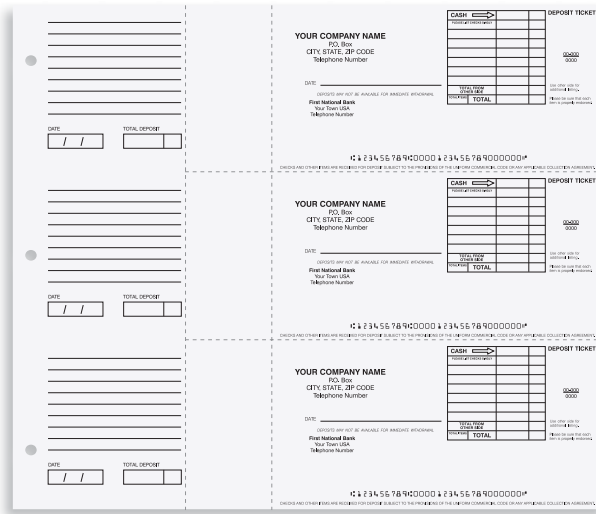

B **DT-414 - 3-Ring Deposit Tickets**
Payroll Deposit Tickets, 7 $\frac{1}{16}$ " x 3 $\frac{3}{8}$ "
13" x 11" Overall
1-Part – 300 Deposit Tickets/100 Sheets

Smaller Size

C **DT-415 - 3-Ring Deposit Tickets**
General Expense Deposit Tickets, 8 $\frac{1}{4}$ " x 3"
13" x 9" Overall
1-Part – 300 Deposit Tickets/100 Sheets

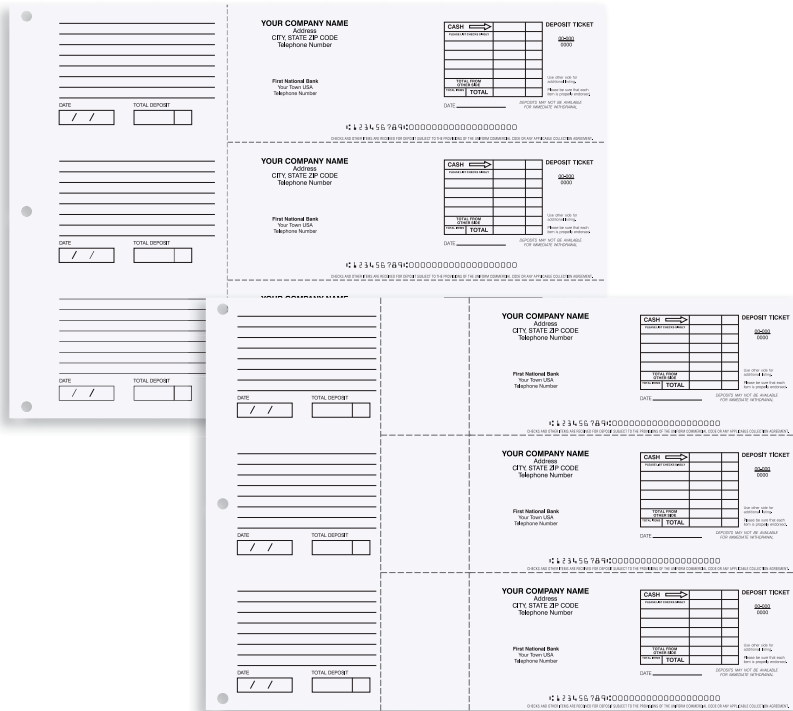

D **DT-416 - 3-Ring Deposit Tickets**
Payroll Deposit Tickets, 7 $\frac{1}{4}$ " x 3"
13" x 9" Overall
1-Part – 300 Deposit Tickets/100 Sheets

A **DT-413 - General Expense Deposit Tickets**

Cat. No.	Pts.	Wt. per 100	Lot Prices 100 Sheets
DT-413-1	1	2#	46.02

Available in black ink only. (R)

B **DT-414 - Payroll Deposit Tickets**

Cat. No.	Pts.	Wt. per 100	Lot Prices 100 Sheets
DT-414-1	1	2#	46.02

Available in black ink only. (R)

C **DT-415 - General Expense Deposit Tickets**

Cat. No.	Pts.	Wt. per 100	Lot Prices 100 Sheets
DT-415-1	1	2#	46.02

Available in black ink only. (R)

D **DT-416 - Payroll Deposit Tickets**

Cat. No.	Pts.	Wt. per 100	Lot Prices 100 Sheets
DT-416-1	1	2#	46.02

Available in black ink only. (R)

NOTE:





A RB-9984
3-Ring Check Binder, 14 $\frac{3}{4}$ " x 11 $\frac{1}{2}$ "
Vinyl
Checks not included.

RB-9985 - SMALLER SIZE
3-Ring Check Binder, 14" x 10"
Vinyl
Checks not included

RB-9987
3-Ring Check Binder, 14 $\frac{3}{4}$ " x 11 $\frac{1}{2}$ "
55 Gauge Polyethylene
Checks not included



DAILY CASH REPORT

REG. No. _____ DATE _____
CLERK _____

CASH FROM SALES	\$	
	\$	
	\$	
TOTAL CASH		\$
CASH FROM TAXES	\$	
	\$	
	\$	
TOTAL CASH		\$
RECEIPTS ON HAND	\$	
	\$	
	\$	
TOTAL RECEIPTS		\$
CASH PAID OUT	\$	
	\$	
	\$	
TOTAL FOR THE DAY		\$
NET RECEIPTS		\$
NET CASH		\$
CASH IN OVER / SHORT		\$
DEPOSITED IN BANK		\$

B DCR-9930
Daily Cash Report Envelope
6" x 9"



Thank you for banking with us!

Thinking about starting a savings account for your child?

Ask us about our Youth Accounts!

Sample Artwork

www.YourCreditUnionOne.com

C ENV-4420
Teller Helper Envelope, 7 x 3 $\frac{3}{4}$ "
Front imprint area 3 $\frac{1}{4}$ " x 7"
Flap imprint area 3" x $\frac{3}{4}$ "
Latex self seal

ENV-4421
Teller Helper Envelope, 7 x 3 $\frac{3}{4}$ "
Front imprint area 3 $\frac{3}{4}$ " x 7"
Flap imprint area 2 $\frac{1}{2}$ " x $\frac{3}{4}$ "
Latex self seal

Your Custom art will be used. 1-color to 4-color, same low price.



A RB-9984, 9985, 9987 - 3-Ring Check Binder

Cat. No.	Size	Material	Wt.	Per Binder
9984	14 $\frac{3}{4}$ " x 11 $\frac{1}{2}$ "	Vinyl	1#	34.75
9985	14" x 10"	Vinyl	1#	34.75
9987	14 $\frac{3}{4}$ " x 11 $\frac{1}{2}$ "	Polyethylene	1#	40.85

Checks not included. (R)

B DCR-9930 - Daily Cash Report Envelope

Cat. No.	Wt. per 1000	Lot Prices				
		100	250	500	1000	2000
9930	24#	55.59	79.40	132.44	219.91	374.35

Not available imprinted. (R)

C ENV-4420, ENV-4421 - Teller Helper Envelope

Cat. No.	Size	Wt. per 250	Imprinted Lot Prices			
			100	250	500	2500
4420	7" x 3 $\frac{3}{4}$ "	3#	77.50	135.00	253.33	570.00
4421	7" x 3 $\frac{3}{4}$ "	3#	77.50	135.00	253.33	570.00

1-color to 4-color process is the same price. (R)

NOTE:

! For Binder Checks, see pages 90-91.

Document Jackets

Format 2
Real Estate

Format 3
Medical 1

Format 4
Medical 2

Format 5
Personnel

Format 6
Job Ticket

Format 7
Wedding

B ENV-9955 - 9959
Document Jackets
28# Prism-Colors, 12" x 9 1/4"
Imprint area 8 1/2" x 10 1/16"
Front or back

Format 1 - Automotive

Back
Front

BEST SELLER

Year _____ Stock No. _____ Sold To _____
 Make _____ Date Sold _____ Address _____
 VIN _____ Invoice No. _____ City _____
 Motor No. _____ Mileage _____ State _____ Zip _____
 Key No. _____ Int R.O. No. _____ Phone No. _____
 TRUNK _____ BUS _____
 Date of Purchase _____
 Purchased From _____ Bill of Sale
 Address _____ Certificate of Title
 City _____ Odometer Certification
 State _____ Zip _____
 Title No. _____
 License No. _____

YOUR COMPANY NAME
 Address _____
 CITY STATE ZIP CODE _____
 Phone Number _____
 Advertising Line _____

Received Title _____

A ENV-9940
Document Jackets
100# Manila Tag, 12" x 9 1/4"
Imprint area 8 1/2" x 10 1/16"
Front or Back

A ENV-9940 Document Jackets - Manila

Cat. No.	Wt. per 1000	Lot Prices			
		250	500	1000	2500
ENV-9940	58#	182.78	245.80	351.05	691.24
Blank Lot Prices					
9940	58#	137.12	208.99	317.56	660.56

Printing on second side for additional charge. (R)
 Printed on 100# Manila Tag.

B ENV-9955 - 9959 Document Jackets - Colors

Cat. No.	Color	Wt. per 1000	Imprinted Lot Prices			
			250	500	1000	2500
9955	Canary	58#	227.29	293.23	430.92	984.83
9956	Blue	58#	227.29	293.23	430.92	984.83
9957	Green	58#	227.29	293.23	430.92	984.83
9958	Pink	58#	227.29	293.23	430.92	984.83
9959	White	58#	227.29	293.23	430.92	984.83
Blank Lot Prices						
9955	Canary	58#	170.51	234.68	408.46	954.15
9956	Blue	58#	170.51	234.68	408.46	954.15
9957	Green	58#	170.51	234.68	408.46	954.15
9958	Pink	58#	170.51	234.68	408.46	954.15
9959	White	58#	170.51	234.68	408.46	954.15

Printing on second side for additional charge. (R)
 Printed on 28# Prism.

NOTE:



Includes your company's name, address and phone number in one of four colors! For blank forms, subtract 30%.



! Choose from one of our standard formats or submit your custom copy.



PF-8832 Presentation Folder

Double pocket, 9" x 12" overall
 Business card slits on one pocket included
 Imprint: As shown with design, one color or foil
 Line 1: 25 characters
 Line 2-4: 30 characters each
 Foil imprint: Max 16 square inches



PF-8833 Presentation Folder

Single pocket, 9" x 12" overall
 Business card slits included
 Imprint: As shown with design, one color or foil
 Line 1: 20 characters
 Line 2-4: 30 characters each
 Foil imprint: Max 16 square inches

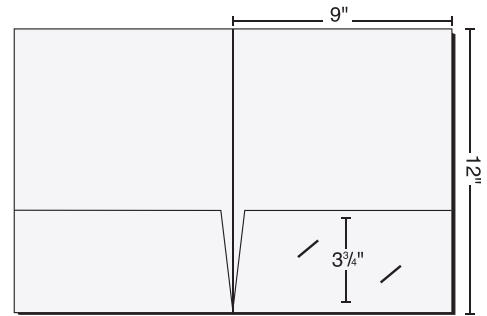

Right pocket only for PF-8833



PF-8834 Presentation Folder

Reinforced double pocket, 9 7/8" x 11 3/4" overall
 Business card slits on one pocket included
 Imprint: As shown with design, one color or foil
 Line 1: 20 characters
 Line 2-4: 25 characters each
 Foil imprint: Max 16 square inches

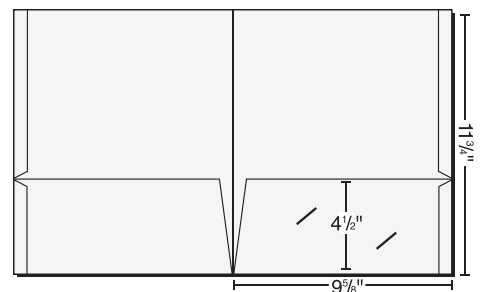

The edges are folded and glued

PF-8833, 8832, 8834 Presentation Folders

Cat. No.	Wt.	Imprinted Lot Prices				
		per 500	500	1000	1500	2000
8832	55#	850.00	1300.00	1600.00	2000.00	2700.00
8833	55#	850.00	1300.00	1600.00	2000.00	2700.00
8834	55#	850.00	1300.00	1600.00	2000.00	2700.00

(R)

NOTE:

Proof Information

Black & White Laser Proof \$11.00
 PDF Proof (Not for color) \$11.00
 Normal production time is required after return of proof.
 Changes made at proofing may incur additional charges.
 Proofs must be requested at time of order.

Imprint Colors

May be imprinted in black, 1 PMS color or one of the following foils:

Rainbow	Black	White	Copper
Shiny Gold	Flat Gold	Shiny Silver	Flat Silver
Red	Burgundy	Green	Light Blue
Medium Blue	Turquoise	Purple	

Stock Papers

Rite: Coated 10 pt C1S (White)
 Felt 80# Cover (Snow White)
 Linen 80# Cover (Snow White)

Mohawk Loop: Feltmark 80# Cover (Granite, Ivory)
 Linen 80# Cover (Gray, Ivory)
 Smooth 80# Cover (Granite, Ivory)



Stock Colors



Envelopes

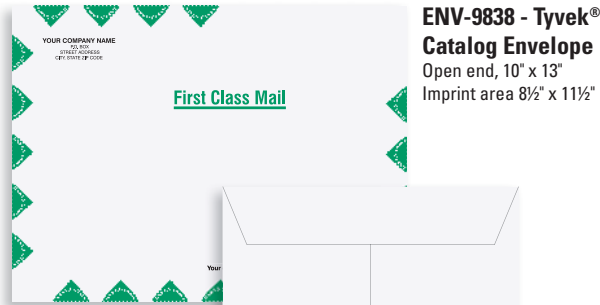

**ENV-9838 - Tyvek®
Catalog Envelope**
Open end, 10" x 13"
Imprint area 8½" x 11½"

**ENV-9839 - Tyvek®
Catalog Envelope**
Open end, 9" x 12"
Imprint area 8¾" x 11¼"

**ENV-9840 - Tyvek®
Catalog Envelope**
Open end, 10" x 13"
Imprint area 9½" x 12¼"

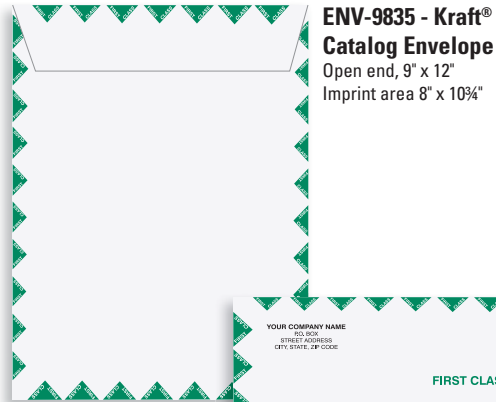

**ENV-9835 - Kraft®
Catalog Envelope**
Open end, 9" x 12"
Imprint area 8" x 10¾"



**ENV-9837 - Kraft®
Catalog Envelope**
Open end, 10" x 13"
Imprint area 9" x 12"



**ENV-9832 - White 28#
Booklet Envelope**
Open side, 6" x 9"
Imprint area 5¾" x 8¼"

**ENV-9834 - White 28#
Booklet Envelope**
Open side, 9" x 12"
Imprint area 8¾" x 11¼"



**ENV-9833 - White 28#
Catalog Envelope**
Open end, 9½" x 12½"
Imprint area 8¾" x 11¼"

**ENV-9831 - White 24#
Catalog Envelope**
Open end, 6" x 9"
Imprint area 5¾" x 8¼"

Tyvek® Envelopes

Cat. No.	ENV- Size	Wt. per 1000	Imprinted Lot Prices			
			100	250	500	1000
9838	10" x 13"	24#	151.89	306.64	518.18	830.70
9839	9" x 12"	20#	130.05	268.58	462.85	744.48
9840	10" x 13"	24#	144.51	292.08	505.08	797.11

Back printing not available. (R)
Available in black ink only.

Kraft® Envelopes

Cat. No.	ENV- Size	Wt. per 1000	Imprinted Lot Prices			
			100	250	500	1000
9835	9" x 12"	38#	82.21	112.79	176.12	277.84
9837	10" x 13"	44#	100.31	136.19	224.69	351.78

Back printing not available. (R)

White Envelopes

Cat. No.	ENV- Size	Wt. per 1000	Imprinted Lot Prices			
			100	250	500	1000
9831	6" x 9"	24#	57.46	85.44	124.12	180.18
9832	6" x 9"	28#	57.04	84.92	111.75	163.54
9833	9½" x 12½"	42#	79.09	113.00	176.02	278.04
9834	9" x 12"	38#	81.17	112.79	150.44	216.16

Back printing not available. (R)

NOTE:



Includes your company's name, address and phone number in one of four colors! For blank forms, subtract 30%.



DuPont™
Tyvek®
Protect what's inside.™
Tyvek® Envelopes have pressure sensitive seals.

! Deduct 30% for blank envelopes these two pages.

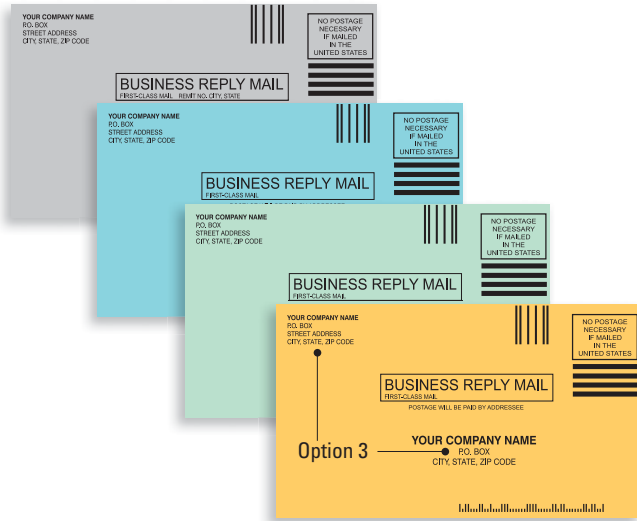

ENV-9814-9818 - #6 3/4 Envelopes
3 1/2" x 6"

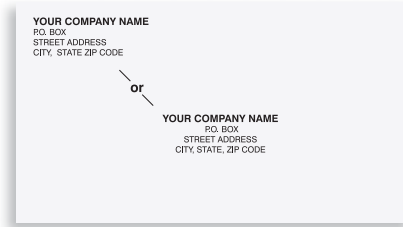

ENV-9823 - #6 3/4 Envelopes
Tinted, 3 3/8" x 6 1/2"

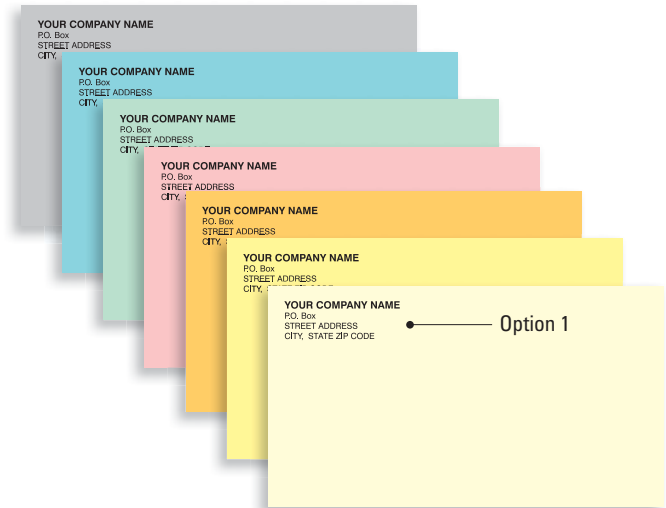

ENV-9824-9830 - #6 3/4 Envelopes
3 3/8" x 6 1/2"

#6 3/4 & #6 3/4 Envelopes

Cat. No.	ENV-	Size	Color	Wt. per 500	Imprinted Lot Prices			
					500	1000	2000	4000
9814	#6 3/4	Gray	5#	72.05	108.15	170.07	309.83	
9815	#6 3/4	Blue	5#	72.05	108.15	170.07	309.83	
9816	#6 3/4	Green	5#	72.05	108.15	170.07	309.83	
9818	#6 3/4	Goldenrod	5#	72.05	108.15	170.07	309.83	
9823*	#6 3/4	White	5#	72.05	108.15	170.07	309.83	
9824	#6 3/4	Gray	5#	72.05	108.15	170.07	309.83	
9825	#6 3/4	Blue	5#	72.05	108.15	170.07	309.83	
9826	#6 3/4	Green	5#	72.05	108.15	170.07	309.83	
9827	#6 3/4	Pink	5#	72.05	108.15	170.07	309.83	
9828	#6 3/4	Goldenrod	5#	72.05	108.15	170.07	309.83	
9829	#6 3/4	Canary	5#	72.05	108.15	170.07	309.83	
9830	#6 3/4	Creme	5#	72.05	108.15	170.07	309.83	

*Tinted inside.

(R)

#9 Envelopes

Cat. No.	ENV-	Size	Color	Wt. per 500	Imprinted Lot Prices			
					500	1000	2000	4000
9804	#9	Gray	7#	99.43	137.06	217.60	322.93	
9805	#9	Blue	7#	99.43	137.06	217.60	322.93	
9806	#9	Green	7#	99.43	137.06	217.60	322.93	
9807	#9	Pink	7#	99.43	137.06	217.60	322.93	
9809	#9	Canary	7#	99.43	137.06	217.60	322.93	
9810	#9	Creme	7#	99.43	137.06	217.60	322.93	

(R)

NOTE:

3 Imprint options available in all sizes.

- 1 - Upper Left
- 2 - Center
- 3 - Barcoded - Upper Left or Center



ENV-9804-9810 - #9 Envelopes
3 3/8" x 8 3/8"

Envelopes

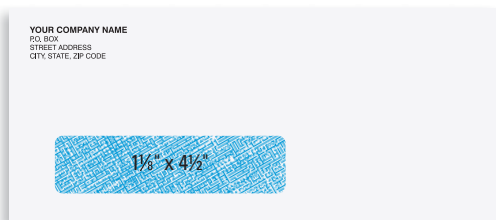

ENV-9901 - #10 Envelope
Security window, 4 1/8" x 9 1/2"

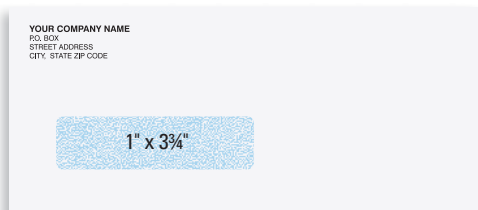

ENV-9905 - #9 Automotive Invoice Envelope
Security window, 3 7/8" x 8 3/4"

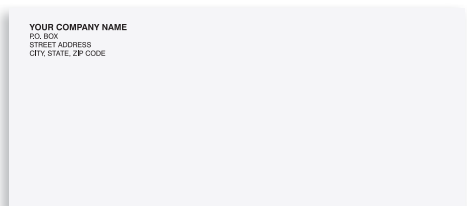

ENV-9906 - #9 Envelope
Regular (no window), 3 7/8" x 8 3/4"

ENV-9962 - #9 Envelope
Regular (no window), 3 7/8" x 8 3/4", **Recycled**

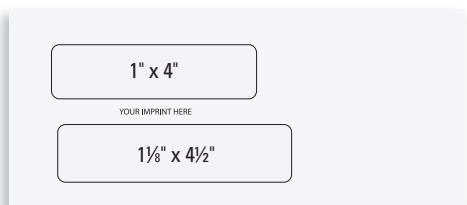

ENV-9907 - #9 Envelope
Double window, 3 7/8" x 8 3/4"

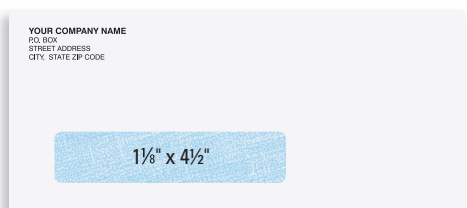

ENV-9908 - #9 Envelope
Security window, 3 7/8" x 8 3/4"

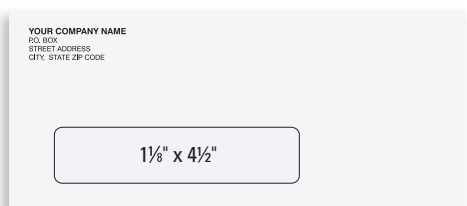

ENV-9909 - #9 Envelope
Single window, 3 7/8" x 8 3/4"

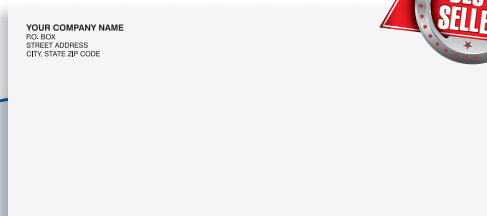

ENV-9910 - #10 Envelope
Regular (no window), 4 1/8" x 9 1/2"

ENV-9963 - #10 Envelope
Regular (no window), 4 1/8" x 9 1/2", **Recycled**

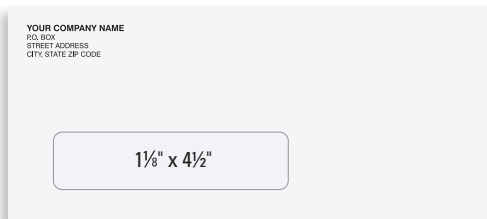

ENV-9911 - #10 Envelope
Single window, 4 1/8" x 9 1/2"

ENV-9964 - #10 Envelope
Single window, 4 1/8" x 9 1/2", **Recycled**



ENV-9912 - #10 Envelope
Double window, 4 1/8" x 9 1/2"

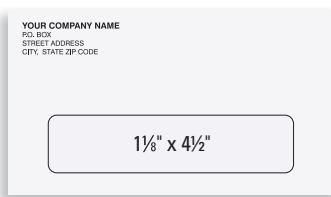

ENV-9913 - #6 3/4 Envelope
Single window, 3 7/8" x 6 1/2"

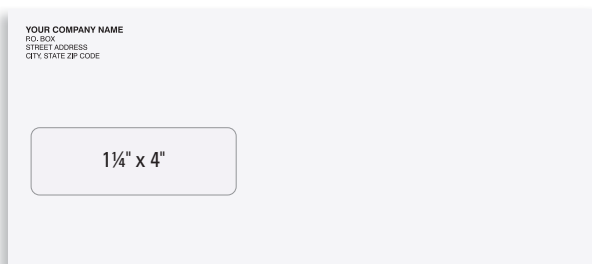

ENV-9914 - #14 Envelope
Single window, 5" x 11 1/8"

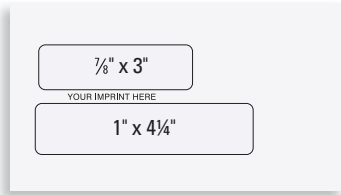

ENV-9915 - #6³/₄ Envelope
Double window, 3⁵/₈" x 6¹/₂"

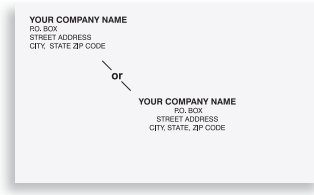

ENV-9916 - #6³/₄ Envelope
Regular (no window), 3¹/₂" x 6"

ENV-9919 - #6³/₄ Envelope
Regular (no window), 3⁵/₈" x 6¹/₂"

See page 99 for imprint position options.

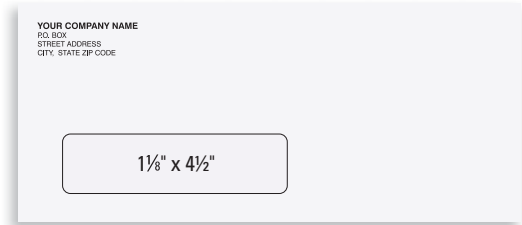

ENV-9917 - #10 Envelope
Self-sealing (no window), 4¹/₈" x 9¹/₂"

ENV-9918 - #10 Envelope
Self-sealing, single window, 4¹/₈" x 9¹/₂"

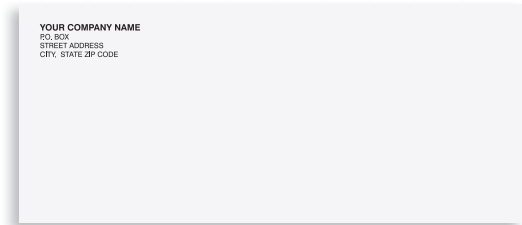

ENV-9937 - #10 Envelope
Tinted regular (no window), 4¹/₈" x 9¹/₂"
See page 99 for imprint position options.

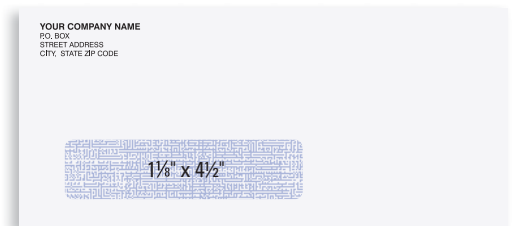

ENV-9939 - #10 Envelope
Tinted, self-sealing, single window
4¹/₈" x 9¹/₂"

ENV-9938 - #10 Envelope
Tinted, self-sealing (no window)
4¹/₈" x 9¹/₂"

Envelopes

Cat. No.	Size	Wt. per 500	Imprinted Lot Prices				
			500	1000	2000	3000	5000
9901	10	8#	71.71	110.29	218.04	322.66	535.44
9905	9	7#	71.71	110.29	218.04	322.66	535.39
9906	9	7#	51.84	81.90	162.19	240.50	402.74
9907	9	7#	90.74	153.76	287.82	411.58	652.86
9908	9	7#	107.59	161.98	272.84	371.64	600.13
9909	9	7#	66.92	107.48	197.34	284.80	461.40
9910	10	8#	71.60	119.96	209.09	303.32	491.04
9911	10	8#	74.10	127.66	229.89	334.83	540.75
9912	10	8#	89.28	159.69	294.06	435.29	675.32
9913	6 ³ / ₄	5#	75.97	125.58	222.51	321.52	518.80
9914	14	10#	103.12	153.76	287.40	411.27	642.67
9915	6 ³ / ₄	5#	87.52	149.29	277.42	393.90	629.67
9916	6 ³ / ₄	5#	73.79	110.50	205.56	294.27	451.20
9919	6 ³ / ₄	5#	69.42	119.65	215.44	305.40	492.49
9937	10	8#	83.04	125.37	227.50	318.08	492.39
ENV-	Blank Lot Prices						
9914	14	10#	87.62	130.68	244.45	349.60	546.26
9937	10	8#	58.08	87.72	159.28	222.61	344.60

All others deduct 30% for blank envelopes. (R)

Recycled Envelopes

Cat. No.	Size	Wt. per 500	Imprinted Lot Prices			
			500	1000	2000	5000
9962	9	7#	69.11	110.08	187.25	452.24
9963	10	8#	75.24	126.10	219.60	515.58
9964	10	8#	77.84	133.90	241.23	567.79

Deduct 30% for blank envelopes. (R)

Self Sealing Envelopes

Cat. No.	Size	Wt. per 500	Imprinted Lot Prices		
			500	1000	2000
9917	10	8#	106.03	184.65	343.88
9918	10	8#	136.81	194.95	363.22
9938	10	8#	131.20	188.92	325.16
9939	10	8#	137.54	197.24	339.20
ENV-	Blank Lot Prices				
9917	10	8#	97.60	134.94	251.94
9918	10	8#	108.52	145.34	271.28
9938	10	8#	107.80	144.40	272.43
9939	10	8#	127.35	182.78	314.44

(R)

Recycled Envelopes are 24# White Recovery which meets or exceeds the 30% recycled content guidelines for EPA. Available in #9 (ENV-9962) or #10 (ENV-9963) regular no window or #10 (ENV-9964) single window versions.

NOTE:

Envelope Window Positioning

Item	Bottom	Left
9901	1/2"	7/8"
9905	13/16"	7/8"
9907	Top Window: 2 1/4"	1 1/16"
	Bottom Window: 9/16"	7/8"
9908	1/2"	7/8"
9909	1/2"	7/8"
9911	1/2"	7/8"
9912	Top Window: 2 1/4"	1 1/16"
	Bottom Window: 7/8"	5/8"
9913	9/16"	7/8"
9914	1 1/16"	3/8"
9915	Top Window: 2 1/16"	1/2"
	Bottom Window: 3/4"	7/16"
9918	1/2"	7/8"
9939	1/2"	7/8"

Need Special Information Added to the Face of Your Envelope?

You can choose from:

- Statement Enclosed
- Reply Requested
- Important Information
- Bill Enclosed
- Open Immediately
- Special Offer

or Submit Your Own Copy



Includes your company's name, address and phone number in one of four colors! For blank forms, subtract 30%.

! Don't see the Envelope you need? We can get it for you.



Create The Perfect Form.

You can create a form that works for you. You have the choice of eight perf positions or no perf. Add one or two file holes in the top or bottom or three hole punches for a binder.

Finish your form with one or all of these **FREE** options.

- One of our Stock Logos from pages 134-136
- Stock Logo as a phantom
- White, Navy Blue, Hunter Green or Burgundy paper
- Choice of Form Identifier

We will print your 1-color Full Page Custom Design for just \$63.31(R) additional art charge.

Note: Blank My Choice CreationsSM colors are the same as imprinted price per lot. For blank white stock, deduct 30%.

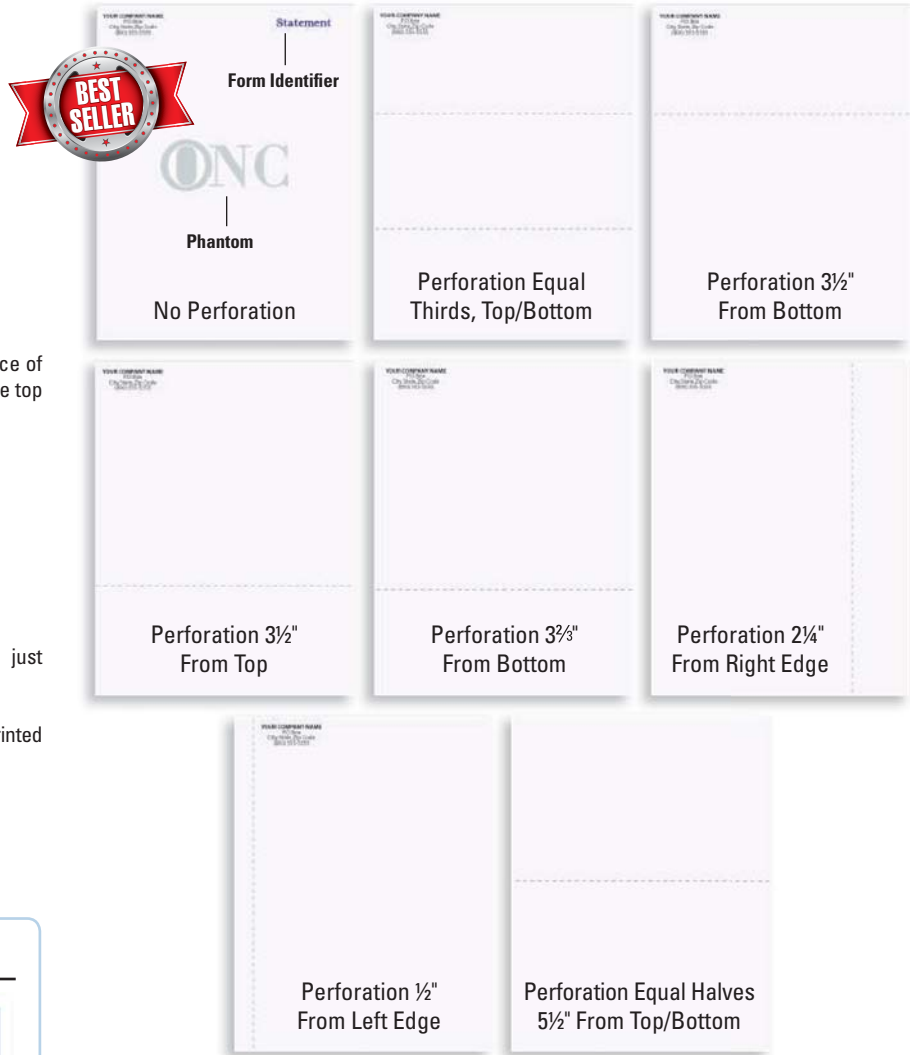

NOTE:

Available in White or 3 Great Colors!



Burgundy
PMS-1955

Hunter Green
PMS-336

Navy Blue
PMS-294

For Blank White Stock, deduct 30%.

FREE! – Add a Form Identifier

For available timesteps, see page 104.

- | | | |
|-------------------|--------------|-----------------|
| • Statement | • Past Due | • Receipt |
| • Purchase Order | • Proposal | • Bulletin |
| • Sales Order | • Reminder | • Urgent |
| • Packing List | • Invoice | • Credit Memo |
| • Overdue Account | • Work Order | • Change Notice |
| • Thank You | • Quotation | • Final Notice |
| • Debit Memo | • Memo | • Requisition |
| • Agreement | • Estimate | • Job Invoice |

Sample **STATEMENT**

Company Imprint
Includes your company's name, address and phone number in one of four colors! For blank forms, subtract 30%.

1 Day Blank **5 Day Imprint**
Shipping

My Choice CreationsSM 8 1/2" x 11" Perforated Stock

Cat. No.		Position	Wt. per 1000	Imprinted Lot Prices				
20#	24#			250	500	1000	2000	3000
5701	5711	No Perf	11#	76.49	115.08	148.56	239.88	317.67
5702	5712	Equal Thirds	11#	76.49	115.08	148.56	239.88	317.67
5703	5713	3 1/2" from Top	11#	76.49	115.08	148.56	239.88	317.67
5704	5714	3 1/2" from Bottom	11#	76.49	115.08	148.56	239.88	317.67
5705	5715	3 3/8" from Bottom	11#	76.49	115.08	148.56	239.88	317.67
5706	5716	2 1/4" from Rt. Edge	11#	76.49	115.08	148.56	239.88	317.67
5708	5718	1/2" from Lt. Edge	11#	76.49	115.08	148.56	239.88	317.67
5709	5719	Equal Halves	11#	76.49	115.08	148.56	239.88	317.67

Not available numbered.

Envelopes available on page 100. (9910)

For Hole Punched Forms, add:

	Lot Prices				
	250	500	1000	2000	3000
1 & 2 Hole Punch	24.63	24.63	24.63	29.22	33.61
3 & 4 Hole Punch	38.91	38.91	38.91	43.61	46.97

1/4" hole, 1/4" from the edge of the paper.

(R)

Don't Forget Your Compatible Envelopes. All My Choice Creations forms fit our standard #10 envelope (ENV-9910, no window). See page 100.

Reliable. Dependable. Professional. Make the best impression with your business stationery.

Your business stationery, letterhead, envelopes and business cards are important investments. They can be the first impression your client receives about your business. Make that image one that will impress your clients with your dependability and strength.



A Envelopes
Standard size #9 & #10

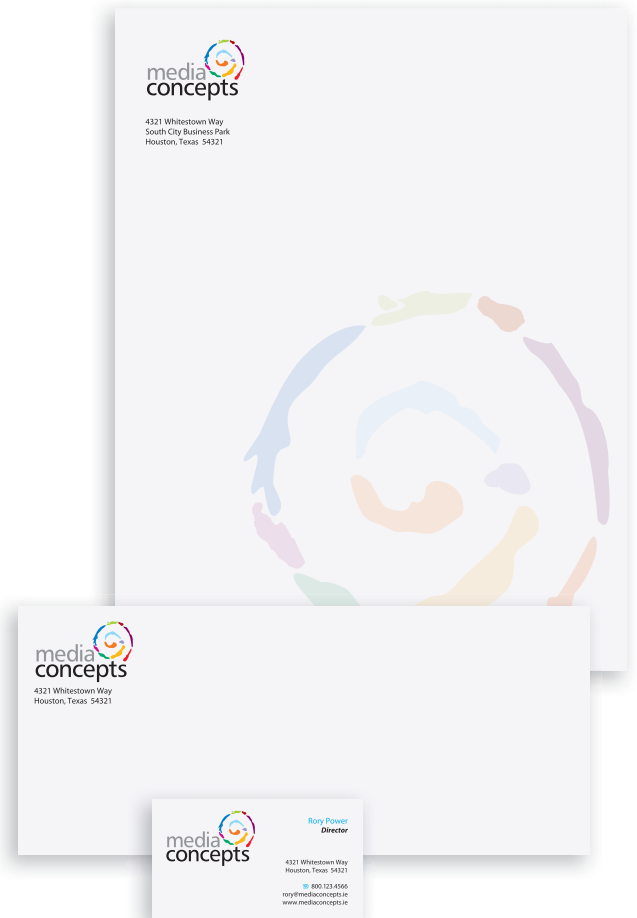

B 495650 - Business Stationery Package
24# white accent opaque paper
Card stock is 65#

A Full-Color Envelopes

Cat. No.	Description	Wt. per 500	Imprinted Lot Prices			
			250	500	1000	2500
495660	#10 Regular	8#	112.68	145.55	164.68	329.42
495670	#9 Regular	8#	112.68	145.55	164.68	329.42
495680	#10 Window	8#	121.37	154.28	173.37	364.10
495690	#10 Window with Tint	8#	124.80	159.48	182.00	381.42

(R)

B Business Stationery Package

Cat. No.	Description	Wt. per 1000	Imprinted Lot Prices			
			250	500	1000	2500
495650	Envelopes, Letterhead, Business Cards	24#	223.60	292.97	362.34	674.39

No Watermark
Letterhead 8½" x 11"
#10 Envelope 4½" x 9½"
Cards 3½" x 2"

(R)

**No Bleeds,
Digital Files Required**

NOTE:



Business Stationery

Choose a typestyle, paper stock and ink color for attractive, matching business stationery. Give your stationery a finished look by adding your company logo for \$39.48(R), first time only charge or choose one of our stock logo's from pages 134-136. Or submit your own custom art.

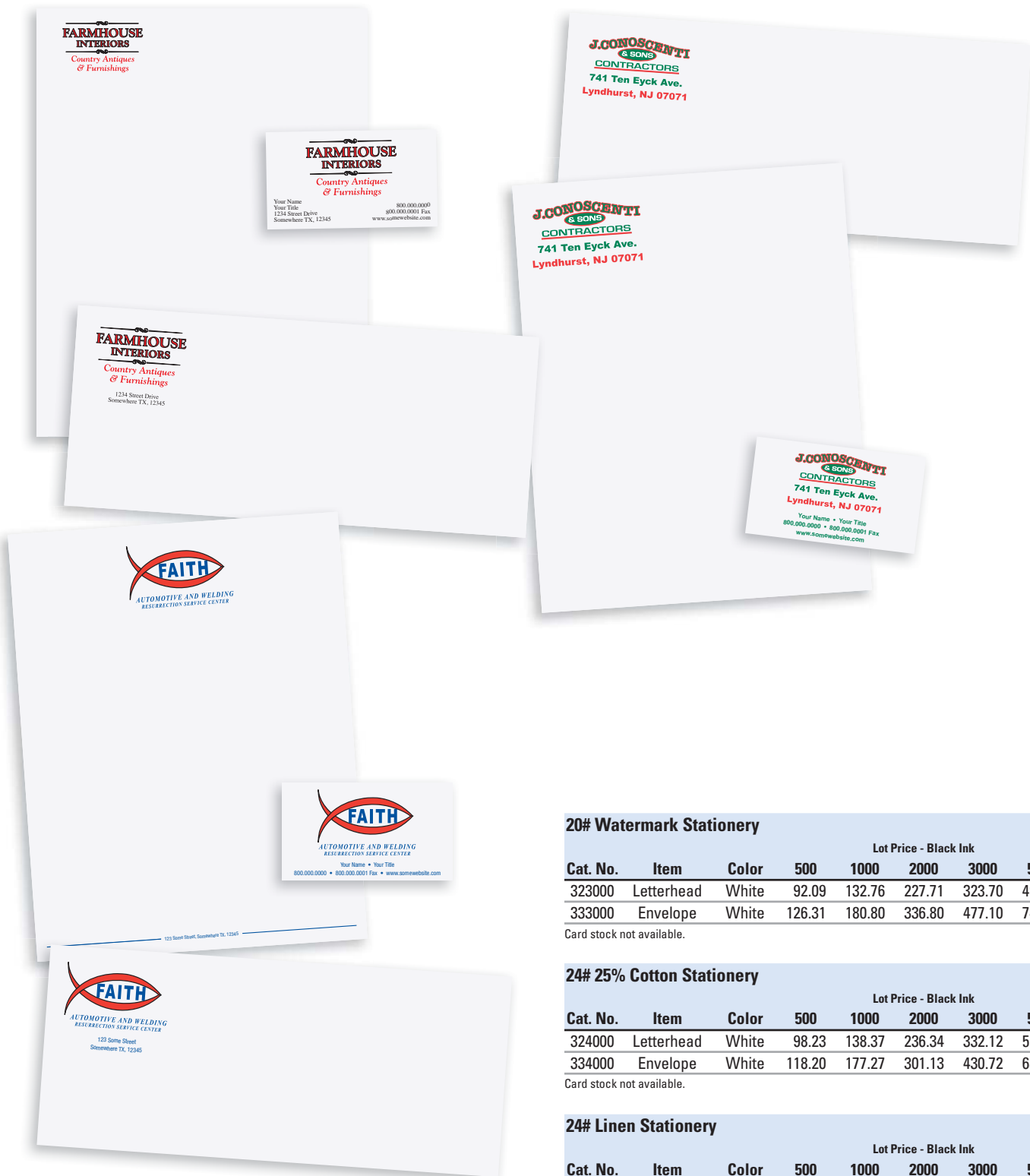

20# Watermark Stationery

Cat. No.	Item	Color	Lot Price - Black Ink				
			500	1000	2000	3000	5000
323000	Letterhead	White	92.09	132.76	227.71	323.70	496.55
333000	Envelope	White	126.31	180.80	336.80	477.10	744.17

Card stock not available. (R)

24# 25% Cotton Stationery

Cat. No.	Item	Color	Lot Price - Black Ink				
			500	1000	2000	3000	5000
324000	Letterhead	White	98.23	138.37	236.34	332.12	516.00
334000	Envelope	White	118.20	177.27	301.13	430.72	680.63

Card stock not available. (R)

24# Linen Stationery

Cat. No.	Item	Color	Lot Price - Black Ink				
			500	1000	2000	3000	5000
325100	Letterhead	White	115.39	158.76	274.09	389.53	608.86
326100	Envelope	White	138.79	197.55	368.11	520.78	814.16

Card stock not available. (R)

24# White Accent Opaque

Cat. No.	Item	Color	Lot Price - Black Ink	
			500	1000
493000	Letterhead	White	122.25	163.64
494000	Envelope	White	131.40	180.49
495000	Card*	White	44.46	48.72

*Card Stock is 65# White Accent Opaque. (R)
No Watermark.

24# Sulphite Ultra White Stationery

Cat. No.	Item	Color	Lot Price - Black Ink	
			500	1000
493640	Letterhead	Ultra White	122.25	163.64
494640	Envelope	Ultra White	131.40	180.49
495640	Card*	Ultra White	44.46	48.72

*Card Stock is 80# Sulphite Cover 95% brightness - Bright White. (R)
No Watermark.

24# Classic Laid Stationery

Cat. No.	Item	Color	Lot Price - Black Ink	
			500	1000
493240	Letterhead	Antique Gray	143.36	184.03
494240	Envelope	Antique Gray	172.59	231.97
495240	Card*	Antique Gray	67.55	86.79

Cat. No.	Item	Color	Lot Price - Black Ink	
			500	1000
493400	Letterhead	Natural White	143.36	184.03
494400	Envelope	Natural White	172.62	231.97
495400	Card*	Natural White	67.55	86.79

*Card Stock is 65# Classic Laid Cover. (R)
Watermarked.
Classic Laid - not available in 4-color.
Bleeds not available.

24# Strathmore Stationery

Cat. No.	Item	Color	Lot Price - Black Ink	
			500	1000
493440	Letterhead	Ultimate White	156.88	204.83
494440	Envelope	Ultimate White	190.58	255.06
495440	Card*	Ultimate White	72.54	92.72

Cat. No.	Item	Color	Lot Price - Black Ink	
			500	1000
493480	Letterhead	Natural White	156.88	204.83
494480	Envelope	Natural White	190.58	255.06
495480	Card*	Natural White	72.54	92.72

*Card Stock is 88# Strathmore Writing Center Bristol Cover. (R)
Watermarked.
Bleeds not available.

24# Classic Linen Stationery

Cat. No.	Item	Color	Lot Price - Black Ink	
			500	1000
493040	Letterhead	Antique Gray	156.88	204.83
494040	Envelope	Antique Gray	190.58	255.06
495040	Card*	Antique Gray	72.54	92.72

Cat. No.	Item	Color	Lot Price - Black Ink	
			500	1000
493080	Letterhead	Baronial Ivory	156.88	204.83
494080	Envelope	Baronial Ivory	190.58	255.06
495080	Card*	Baronial Ivory	72.54	92.72

Cat. No.	Item	Color	Lot Price - Black Ink	
			500	1000
493160	Letterhead	Avon Brilliant White	156.88	204.83
494160	Envelope	Avon Brilliant White	190.58	255.06
495160	Card*	Avon Brilliant White	72.54	92.72

Cat. No.	Item	Color	Lot Price - Black Ink	
			500	1000
493200	Letterhead	Haviland Blue	156.88	204.83
494200	Envelope	Haviland Blue	190.58	255.06
495200	Card*	Haviland Blue	72.54	92.72

*Card Stock is 80# Classic Linen Cover. (R)
Watermarked.
Classic Linen - not available in 4-color.
Bleeds not available.

NOTE:

- Thermography will be used unless specified otherwise. Thermography is NOT laser compatible.
- Black ink is standard. Other colors available at an upcharge.
- Blank stationery is available. Call for prices.
- Paper samples are available.

Additional PMS Ink Colors

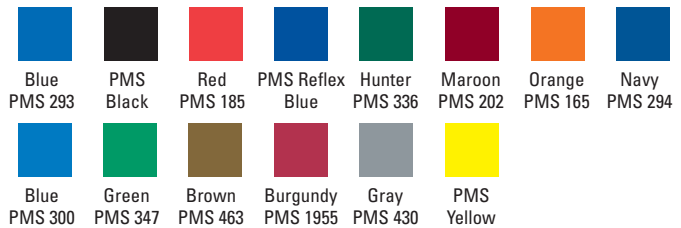

Color other than black	\$30.63
Two Color Combo	\$63.19
Proof	\$15.32
4-color process - letterhead and business cards additional charges	500 1000
	30.60 61.20

Colors shown are approximate. (R)

Available Typestyles

- | | |
|---|--|
| TA1 Bookman
TA2 Bookman Bold
TA3 Bookman Italic
TA4 Bookman Bold Italic
TB1 Helvetica
TB2 Helvetica Bold
TB3 Helvetica Italic
TB4 Helvetica Bold Italic
TC1 Cloister Black
TD1 Zapf Chancery
<i>TE1 Brush Script</i>
<i>TE2 Brush Script Bold Italic</i> | TF1 Kabel Md
TF2 Kabel Md Bold
TG1 Galliard
TG2 Galliard Bold
<i>TG3 Galliard Italic</i>
TG4 Galliard Bold Italic
TH1 Helvetica Narrow
TH2 Helvetica Narrow Bold
TJ1 Benguait
TJ2 Benguait Bold
<i>TJ3 Benguait Italic</i>
TJ4 Benguait Bold Italic |
|---|--|

Sizes

Letterhead 8½" x 11", Envelopes 4¼" x 9½", Cards 2" x 3½"

Shipping Weights

Letterhead 11# per 1,000, Envelopes 10# per 1,000, Cards 3# per 1,000.
Back printing in 1 color is available on business cards for \$33.31(R) additional cost.



Includes your company's name, address and phone number in one of four colors! For blank forms, subtract 30%.



4-Color Process Digital Business Cards

A



A 4-Color Process Digital Business Cards, 10 pt. C1S White

Item Number	Description	Wt. per 1000	500	1000
491200	4CP/Blank	3#	82.11	97.08
491210	4CP/4CP	3#	105.82	119.24

(R)

4-Color Process Digital Business Cards, 12 pt. C1S White

Item Number	Description	Wt. per 1000	500	1000
491220	4CP/Blank	3#	91.68	106.96
491230	4CP/4CP	3#	117.68	134.00

(R)

4-Color Process Digital Business Cards, 10 pt. C2S White

Item Number	Description	Wt. per 1000	500	1000
491240	4CP/Blank	3#	82.11	97.08
491250	4CP/4CP	3#	105.82	119.24

(R)

4-Color Process Digital Business Cards, 12 pt. C2S White

Item Number	Description	Wt. per 1000	500	1000
491260	4CP/Blank	3#	91.68	106.96
491270	4CP/4CP	3#	117.68	134.00

*No thermography available.

(R)

B BIC® Business Card Magnet

Item Number	Description	Price Per Piece			
		500	1000	2500	5000
MGBC30	Card Magnet	0.66	0.58	0.54	0.48

(R)

Size: 3½" x 2"

Stock: 30 mil.

Imprint Color: 4-Color Process.

Personalization: Available for \$3.05(R) per name, up to 25 characters.

Optional Personalization: Multiple names on a minimum quantity order. Get one name printed on a 500 quantity order or ten different names at 50 quantity for each name.

Text should remain within 1⅞" x 3⅜".

Full bleeds available.

Note: Free round corners available.

B



Business Card Magnets

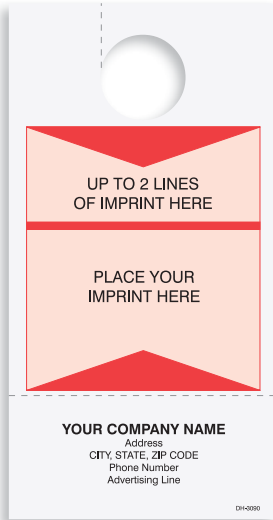

Format-3090
Red Door Hanger
Imprint area: Top 1/2" x 3"
Middle 1 1/4" x 3"
Bottom 1 1/4" x 3 1/8"

Format-3097
Blue Door Hanger
Imprint area: Top 1/2" x 3"
Middle 1 1/4" x 3",
Bottom 1 1/4" x 3 1/8"

Format-3098
Green Door Hanger
Imprint area: Top 1/2" x 3"
Middle 1 1/4" x 3",
Bottom 1 1/4" x 3 1/8"

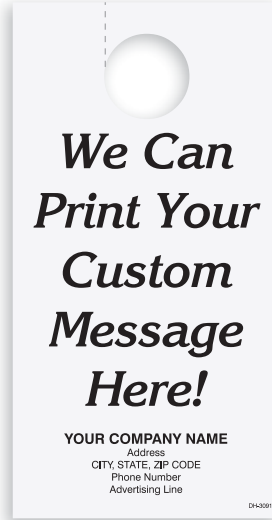

DH-3091
Custom Door Hanger
Imprint area 5" x 3 1/8"

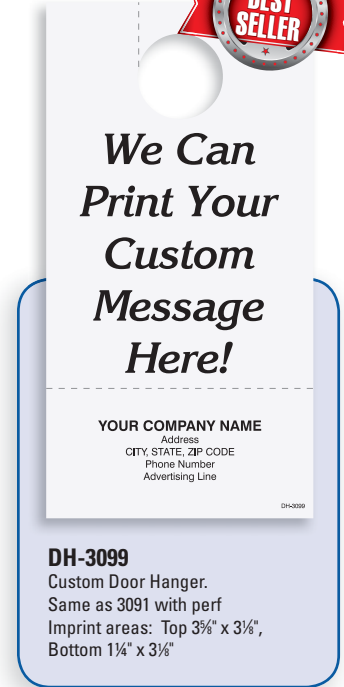

DH-3099
Custom Door Hanger.
Same as 3091 with perf
Imprint areas: Top 3 3/8" x 3 1/8",
Bottom 1 1/4" x 3 1/8"

3 3/8" x 7" Door Hanger

Cat. No.	Message	Wt. per 1000	Lot Prices				
			500	1000	2000	3000	5000
3091	Custom Also Formats 3093, 3094	6#	80.76	111.75	173.11	257.45	422.40
3099	Custom with Perf Also Formats 3090, 3097, 3098	6#	80.76	111.75	173.11	257.45	422.40

(R)

NOTE:

Additional PMS Ink Colors

Blue PMS 293	PMS Black PMS 185	Red PMS 185	PMS Reflex Blue PMS 336	Hunter PMS 336	Maroon PMS 202	Orange PMS 165
Navy PMS 294	Blue PMS 300	Green PMS 347	Brown PMS 463	Burgundy PMS 1955	Gray PMS 430	PMS Yellow

Color other than black \$30.63
2-Color Combo \$63.19
Proof \$15.35
Colors shown are approximate. (R)

Stock

100# White Tag



Includes your company's name, address and phone number in one of four colors! For blank forms, subtract 30%.



- Choose from one of our standard formats or submit your custom copy.
- Back printing available on most door hangers for an additional charge.

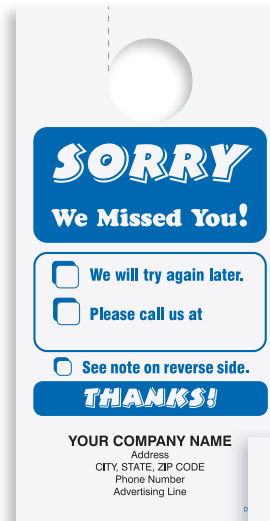

Format-3093
Sorry We Missed You Door Hanger
Imprint area 1" x 3 1/8"

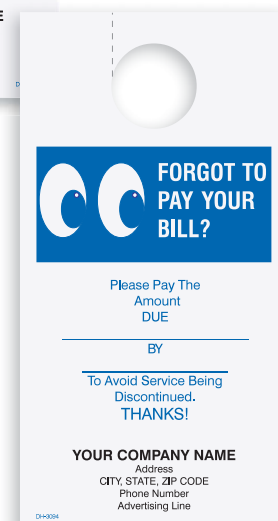

Format-3094
Utility Door Hanger
Imprint area 1" x 3 1/8"

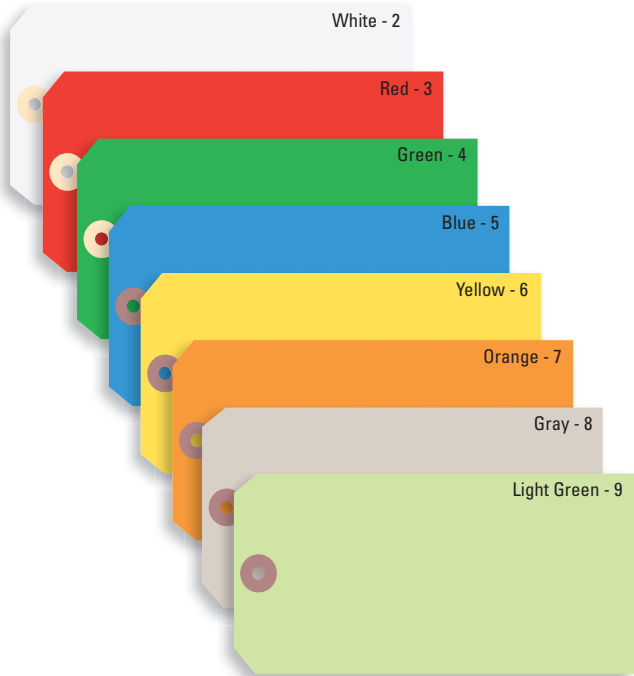

A Blank Tags - Colored
 CSU - 513X - Size 5, 2 $\frac{3}{8}$ " x 4 $\frac{3}{4}$ "
 CSU - 813X - Size 8, 3 $\frac{1}{8}$ " x 6 $\frac{1}{4}$ "
Order by size and color.
 Replace "X" in Cat. No. with the number that corresponds with your choice of color.

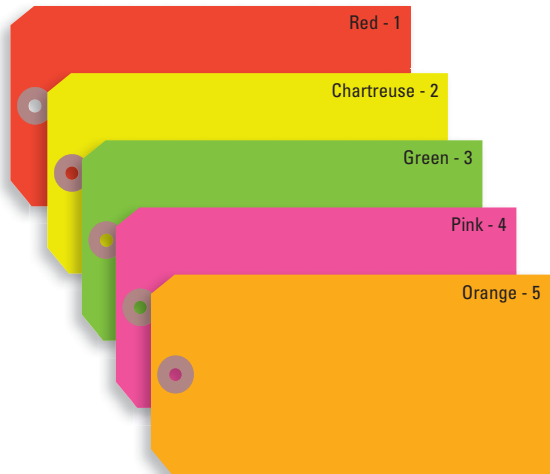

C Blank Tags - Fluorescent Colored
 FCSU - 539X - Size 5, 2 $\frac{3}{8}$ " x 4 $\frac{3}{4}$ "
 FCSU - 839X - Size 8, 3 $\frac{1}{8}$ " x 6 $\frac{1}{4}$ "
Order by size and color.
 Replace "X" in Cat. No. with the number that corresponds with your choice of color.

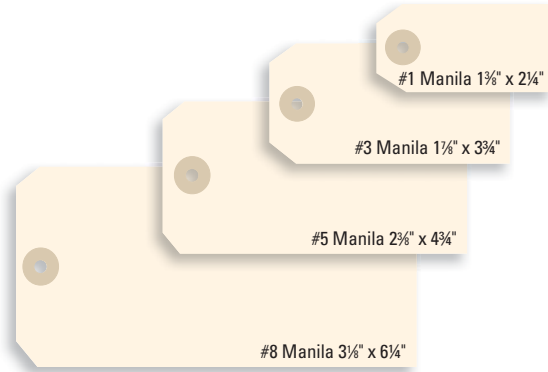

B Blank Tags - Manila
 SU-1131, 3131, 5131, 8131

A Blank Tags - Colored

Cat. No.	CSU- Size	Color	Wt. per 1000	Stock Lot Prices			
				1000	2000	5000	10,000
513X	5	—	6#	59.44	98.96	223.03	396.81
813X	8	—	10#	81.90	136.71	273.78	546.05

Available imprinted and numbered. (R)

B Blank Tags - Manila

Cat. No.	SU- Size	Color	Wt. per 1000	Stock Lot Prices			
				1000	2000	5000	10,000
1131	1	Manila	4#	32.29	56.63	120.59	215.33
3131	3	Manila	4#	36.14	60.37	136.19	243.41
5131*	5	Manila	6#	41.44	69.52	156.26	277.52
8131*	8	Manila	10#	51.22	85.02	191.72	341.69

*Available imprinted and numbered size 5 & 8. Cannot imprint on size 1 & 3. (R)

C Blank Tags - Fluorescent Colored

Cat. No.	FCSU- Size	Color	Wt. per 1000	Stock Lot Prices			
				1000	2000	5000	10,000
539X	5	—	6#	74.20	123.71	278.77	496.03
839X	8	—	10#	102.39	170.92	342.32	682.60

Available imprinted and numbered. (R)

D Tag Connectors*

Cat. No.	Description	Price per 1000
1209	Twine - Cut String - 12", No.9 Gauge	18.36
1226	Loose Wire - 12", No.26 Gauge	12.43

*Image not shown. (R)

NOTE:

#5 & #8 Tags	1000	2000	5000	10000
330036 Imprint charge	75.12	145.81	353.08	685.39
330037 Number charge	75.12	145.81	353.08	685.39
330038 String charge	21.47	41.77	101.13	195.89

#5 & #8 colored or manila tags can be crash imprinted & numbered. (R)
 Black ink standard.
 Colors other than black \$30.63(R)
 Four-color process \$30.63 per thousand (R)
 5 days shipping.

4-Color Process Available!



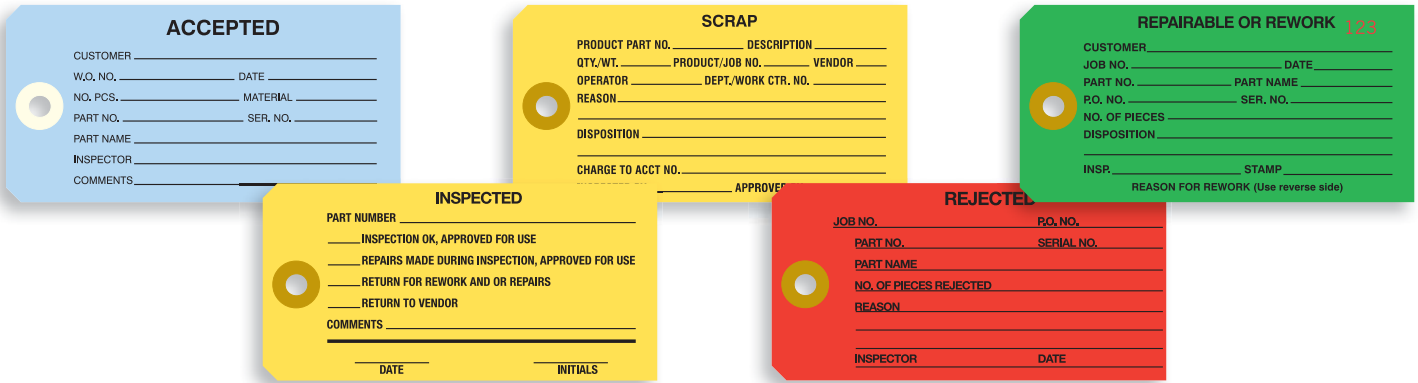

E **PT-165, PTS-165 (w/string), PTW-165 (w/wire)**
2 3/8" x 4 3/4"

E **PT-165, PTS-165, PTW-165 - Work Order Tags**

Cat. No.	Description	Wt. per 1000	Lot Prices			
			1000	2000	5000	10000
165-1	Accepted	5#	61.20	101.87	229.68	408.67
165-2	Scrap	5#	61.20	101.87	229.68	408.67
165-3	Inspected	5#	61.20	101.87	229.68	408.67
165-4	Rejected	5#	61.20	101.87	229.68	408.67
165-5	Repairable	5#	61.20	101.87	229.68	408.67
PTS- (with string)			Lot Prices			
165-1	Accepted	6#	79.51	138.58	321.31	591.92
165-2	Scrap	6#	79.51	138.58	321.31	591.92
165-3	Inspected	6#	79.51	138.58	321.31	591.92
165-4	Rejected	6#	79.51	138.58	321.31	591.92
165-5	Repairable	6#	79.51	138.58	321.31	591.92
PTW- (with wire)			Lot Prices			
165-1	Accepted	6#	80.13	139.72	324.43	598.05
165-2	Scrap	6#	80.13	139.72	324.43	598.05
165-3	Inspected	6#	80.13	139.72	324.43	598.05
165-4	Rejected	6#	80.13	139.72	324.43	598.05
165-5	Repairable	6#	80.13	139.72	324.43	598.05

Not available imprinted. (R)

REPAIR TAG DATE PROMISED

DATE RECEIVED: 0001001

CUSTOMER

ADDRESS

CITY, STATE PHONE

	AMOUNT
DATE WORK COMPLETED	TOTAL

YOUR COMPANY NAME
Address
CITY, STATE, ZIP CODE
Phone Number
Advertising Line

0001001
Thank You

PRINTED IN U.S.A. SIMPLYTEC

F **STR-317 - Tag**
Repair Tag, 3 1/2" x 6 1/4"
Imprint area 1" x 3"

F **STR-317 - Repair Tag**

Cat. No.	STR-	Pts.	Wt. per 1000	Carbonless Lot Prices			
				500	1000	2000	5000
317-2	2	10#	104.57	163.33	261.61	543.45	
317-3	3	12#	130.68	198.80	319.12	688.01	

Pre-strung. Black ink only.
Mylar reinforced back. (R)

G **STR-307 - Repair Tag**

Cat. No.	STR-	Pts.	Wt. per 1000	Stock Lot Prices			
				500	1000	2000	3000
307-1	1	8#	92.30	148.98	243.93	320.48	523.69

Pre-strung. Black ink only.
Mylar reinforced back. (R)

REPAIR TAG PRODUCT 3071

PHONE DATE RECEIVED 001001

CUSTOMER'S NAME

ADDRESS

DATE PROMISED

WORK TO BE DONE

NO REWORK/REPAIR DELIVERED WITHOUT THIS CHECK. NOT RESPONSIBLE FOR GOODS LEFT OVER OR DAMAGED FOR LOSS BY FIRE OR THEFT.

CLAIM CHECK 001001

YOUR COMPANY NAME
Address
CITY, STATE, ZIP CODE
Phone Number
Advertising Line

G **STR-307 - Tag**
Repair Tag, 3 1/2" x 5 1/2"
Imprint area 3/4" x 2 3/4"

NOTE:



Company Imprint

Includes your company's name, address and phone number in one of four colors! For blank forms, subtract 30%.



- ! We also offer Valet Parking Tags. See page 34.
- ! Back of STR-317 and STR-307 are reinforced with mylar.



STR-302-3 REPAIR TAG
PRINTED IN U.S.A.

A 37423

YOUR COMPANY NAME
Address
CITY, STATE, ZIP CODE
Phone Number
Advertising Line

CUSTOMER INV. NO. **A 37423**
ADDRESS
MODEL SER. NO. PHONE
PROBLEM: REC'D. PROMISED

PARTS AND WORK PERFORMED

AMOUNT	
PARTS	
LABOR	
TAX	
TOTAL	

SPECIAL INSTRUCTIONS REC'D. BY

Thank you! CASH ON COMPLETION OF WORK

STR-302-2 REPAIR TAG
PRINTED IN U.S.A.

P 03183

YOUR COMPANY NAME
Address
CITY, STATE, ZIP CODE
Phone Number
Advertising Line

CUSTOMER INV. NO. **P 03183**
ADDRESS
MODEL SER. NO. PHONE
PROBLEM: REC'D. PROMISED

PARTS AND WORK PERFORMED

AMOUNT	
PARTS	
LABOR	
TAX	
TOTAL	

SPECIAL INSTRUCTIONS REC'D. BY

Thank you! CASH ON COMPLETION OF WORK

STR-302-1 REPAIR TAG
PRINTED IN U.S.A.

M 03303

YOUR COMPANY NAME
Address
CITY, STATE, ZIP CODE
Phone Number
Advertising Line

CUSTOMER INV. NO. **M 03303**
ADDRESS
MODEL SER. NO. PHONE
PROBLEM: REC'D. PROMISED

PARTS AND WORK PERFORMED

AMOUNT	
PARTS	
LABOR	
TAX	
TOTAL	

SPECIAL INSTRUCTIONS REC'D. BY

Thank you! CASH ON COMPLETION OF WORK

STR-302-1 REPAIR TAG
PRINTED IN U.S.A.

A 37423

YOUR COMPANY NAME
Address
CITY, STATE, ZIP CODE
Phone Number
Advertising Line

CUSTOMER INV. NO. **A 37423**
ADDRESS
MODEL SER. NO. PHONE
PROBLEM: REC'D. PROMISED

PARTS AND WORK PERFORMED

AMOUNT	
PARTS	
LABOR	
TAX	
TOTAL	

SPECIAL INSTRUCTIONS REC'D. BY

Thank you! CASH ON COMPLETION OF WORK

STR-302-2 REPAIR TAG
PRINTED IN U.S.A.

M 03303

YOUR COMPANY NAME
Address
CITY, STATE, ZIP CODE
Phone Number
Advertising Line

CUSTOMER INV. NO. **M 03303**
ADDRESS
MODEL SER. NO. PHONE
PROBLEM: REC'D. PROMISED

PARTS AND WORK PERFORMED

AMOUNT	
PARTS	
LABOR	
TAX	
TOTAL	

SPECIAL INSTRUCTIONS REC'D. BY

Thank you! CASH ON COMPLETION OF WORK

STR-302-1 REPAIR TAG
PRINTED IN U.S.A.

A 37423

YOUR COMPANY NAME
Address
CITY, STATE, ZIP CODE
Phone Number
Advertising Line

CUSTOMER INV. NO. **A 37423**
ADDRESS
MODEL SER. NO. PHONE
PROBLEM: REC'D. PROMISED

PARTS AND WORK PERFORMED

AMOUNT	
PARTS	
LABOR	
TAX	
TOTAL	

SPECIAL INSTRUCTIONS REC'D. BY

Thank you! CASH ON COMPLETION OF WORK

STR-302-3 REPAIR TAG
PRINTED IN U.S.A.

A 37423

YOUR COMPANY NAME
Address
CITY, STATE, ZIP CODE
Phone Number
Advertising Line

CUSTOMER INV. NO. **A 37423**
ADDRESS
MODEL SER. NO. PHONE
PROBLEM: REC'D. PROMISED

PARTS AND WORK PERFORMED

AMOUNT	
PARTS	
LABOR	
TAX	
TOTAL	

SPECIAL INSTRUCTIONS REC'D. BY

Thank you! CASH ON COMPLETION OF WORK

STR-302-2 REPAIR TAG
PRINTED IN U.S.A.

P 03183

YOUR COMPANY NAME
Address
CITY, STATE, ZIP CODE
Phone Number
Advertising Line

CUSTOMER INV. NO. **P 03183**
ADDRESS
MODEL SER. NO. PHONE
PROBLEM: REC'D. PROMISED

PARTS AND WORK PERFORMED

AMOUNT	
PARTS	
LABOR	
TAX	
TOTAL	

SPECIAL INSTRUCTIONS REC'D. BY

Thank you! CASH ON COMPLETION OF WORK

A STR-302, STC-305, STB-301 - Tag
Repair Tag, 3 1/8" x 9"
Imprint area 3/4" x 2 3/4"

LAY-AWAY TICKET NO. **01786**

Date _____

Name _____

Address _____

Article _____ Sold by _____

Retail Price _____ Tax _____ Total _____

Ticket No. **01786**

Name _____

Address _____

Article _____ Clerk No. _____

PAYMENTS MADE

Date	Tablet Number	Amount	Balance	Rec'd. By

CUSTOMER'S IDENTIFICATION STUB
LAY-AWAY TICKET NO. **01786**

This stub is to be retained until final payment is made and surrendered upon receipt of merchandise. If merchandise is not fully paid for and called for on or before it will be returned to stock unless special arrangements are made.

SOLD By _____ 613

REPAIR TAG

No. **04516** Date _____

Form 653

Owner _____

Address _____

Phone Number _____

Advertising Line _____

REPAIRS

CHARGES

AMT. DUE _____

No. **04516** Promised **CLAIM CHECK**
ALL REPAIRS CASH

NO WORK DELIVERED WITHOUT THIS CHECK
If Goods Are Not Called For In 30 Days They Will Be Sold For Charges.

B TL-3509 - Tag
Manila Layaway Tag, 3 1/8" x 7"

C TR-3510 - Tag
Manila Repair Tag, 2 1/8" x 5 1/2"

A STR-302, STC-305, STB-301 - Repair Tag

Cat. No.	Color	Pts.	Wt.		Lot Prices			
			per 1000	500	1000	2000	3000	5000
STR-302-1	Salmon	1	16#	131.40	208.05	394.63	561.24	884.16
Carbon Lot Prices								
STR-302-3	Salmon	3	20#	195.26	339.40	613.33	913.48	1,494.22
STC-305-2	Yellow	2	18#	180.91	311.32	566.02	828.83	1,343.63
STB-301-2	Blue	2	18#	180.91	311.32	566.02	828.83	1,343.63

Pre-strung. Black ink only. No choice of starting number. (R)

B TL-3509 - Layaway Tag

Cat. No.	Pts.	Wt.		Stock Lot Prices		
		per 1000	500	1000	2000	5000
3509	1	11#	150.12	225.00	337.43	561.96

Pre-strung. Not available imprinted. No choice of starting number. (R)

C TR-3510 - Repair Tag

Cat. No.	Pts.	Wt.		Stock Lot Prices		
		per 1000	500	1000	2000	5000
3510	1	8#	130.57	239.56	359.06	598.47

Pre-strung. Not available imprinted. No choice of starting number. (R)

**We also offer
Work Order forms.
See pages 46 - 49.**

NOTE:

Company
Imprint

Includes your company's name, address and phone number in one of four colors!
For blank forms, subtract 30%.

Shipping

The backer shows a table with columns for DATE, IN, OUT, and BALANCE. The STWCC-323 tag includes fields for INVENTORY DATE, LOCATION, QUANTITY (with units YDS, FT, LBS, PCS, SHTS, DOZ, GR, GAL, BRLS, SETS, RLS, BXS, CTNS, M, C, OTHER), DESCRIPTION, RAW-PROCESS-FINISHED, JOB NO., PART NO., COUNTED BY, CHECKED BY, TAG NO. 24915, and INDEX NO.

Backer

D STWCC-323 - Tag
Inventory Tag, 3 3/8" x 6 1/4"

E STWCC-343 - Tag
Inventory Tag, 3 3/8" x 6 1/4"

The STWCC-313 tag features a 'BEST SELLER' badge, 'IN' and 'OUT' labels, and fields for INVENTORY DATE, QUANTITY, UNIT, SIZE or PART No., DESCRIPTION, RAW - IN PROCESS - FINISHED, LOCATION, COUNTED BY, CHECKED BY, UNIT PRICE, TOTAL VALUE, TAG X 24915, and INDEX NUMBER.

Backer

F STWCC-313 - Tag
Manila Inventory Tag, 3 3/8" x 6 1/4"

D STWCC-323 - Inventory Tag

Cat. No.	Wt.		Carbonless Lot Prices			
STWCC-	Pts.	per 1000	500	1000	2000	5000
323-2	2	8#	149.19	225.94	345.44	575.28

Not available imprinted. No choice of starting number. (R)

E STWCC-343 - Inventory Tag

Cat. No.	Wt.		Carbon Lot Prices			
STWCC-	Pts.	per 1000	500	1000	2000	5000
343-3	3	10#	164.06	248.51	379.96	320.79

Not available imprinted. No choice of starting number. (R)

F STWCC-313 - Inventory Tag

Cat. No.	Wt.		Carbonless Lot Prices			
STWCC-	Pts.	per 1000	500	1000	2000	5000
313-2	2	10#	149.19	225.94	345.44	575.28

Not available imprinted. (R)
Numbering charge for specific starting number. \$54.69(R) per M.

G TI-3513 - Inventory Tag

Cat. No.	Wt.		Stock Lot Prices			
TI-	Pts.	per 1000	500	1000	2000	5000
3513	1	9#	85.23	127.97	217.52	462.33

Pre-Strung. Not available imprinted. No choice of starting number. (R)

The TI-3513 tag includes fields for DATE, INVENTORY, TAG NO. 04464, ARTICLE OR KIND OF MATERIAL, AMOUNT, SIZE, COUNTED BY, UNIT PRICE, LOCATION (BLDG., SEC., FLOOR), PRICED BY, CHECKED BY, REMARKS, TOTAL VALUE, and DATE. It also contains a note: 'Unit means Singles, Pairs, Pcs., Lbs., Ft., Yds., Gals., Reams, Etc. Enter only one item on tag. All tags must be accounted for. If notations are made on back mark X here _____'.

G TI-3513 - Tag
Manila Inventory Tag, 3 3/8" x 6 3/8"

A

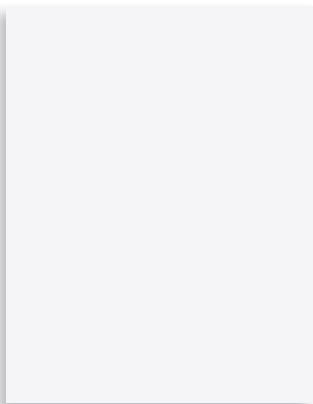

353391 & 393391

8½" x 11" with back score
Compatible with Avery #5165

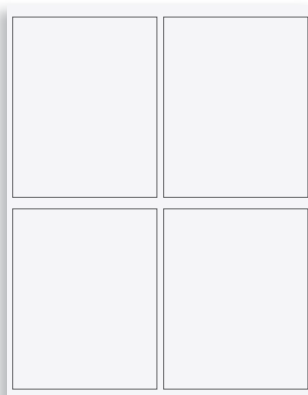

353392 & 393392

Label size 4" x 5"

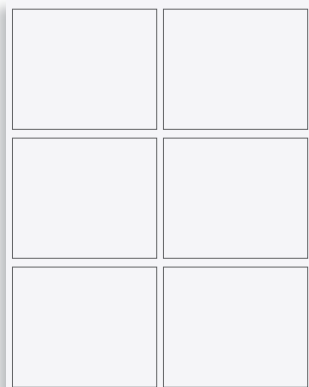

353393 & 393393

Label size 4" x 3½"
Compatible with Avery #5164

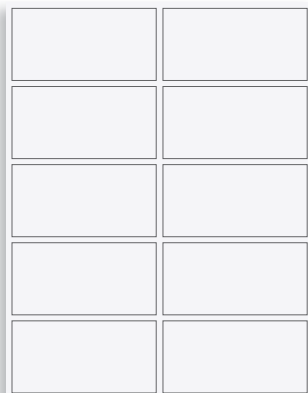

353394 & 393394

Label size 4" x 2"
Compatible with Avery #5163

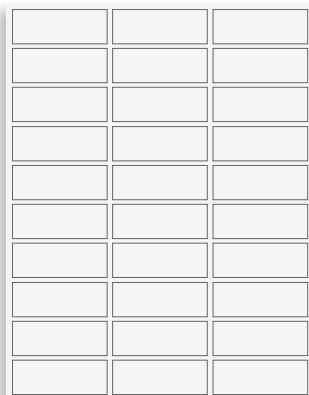

353397 & 393397

Label size 2½" x 1"
Compatible with Avery #5160

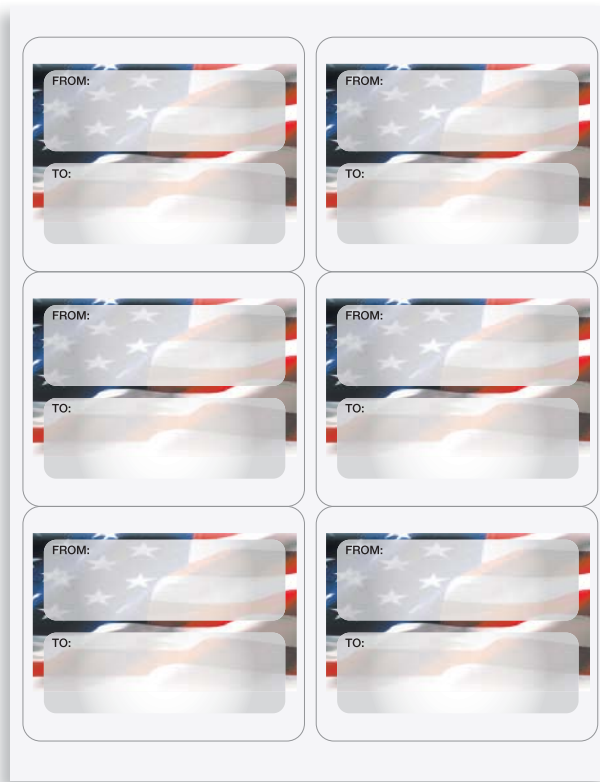

4-color process is available for an additional charge per 100 sheets on Item A.

Additional charge:

100 sheets	200 sheets	300 sheets	400 sheets
42.08	77.69	113.07	142.90 (R)

Imprint size:
393391 - 8" x 10½"
393392 - 3½" x 4½"
393393 - 3½" x 3"
393394 - 3½" x 1½"
393397 - 2½" x ¾"

A Pressure Sensitive Shipping Labels

Cat. No.	Labels per Sheet	Wt. per 100 Sheets	Blank Lot Prices			
			100 Sheets	200 Sheets	300 Sheets	400 Sheets
353391	1	3#	38.95	77.12	102.60	134.11
353392	4	3#	38.95	77.12	102.60	134.11
353393	6	3#	38.95	77.12	102.60	134.11
353394	10	3#	38.95	77.12	102.60	134.11
353397	30	3#	38.95	77.12	102.60	134.11
Imprinted Lot Prices						
393391	1	3#	102.28	145.13	181.43	220.95
393392	4	3#	102.28	145.13	181.43	220.95
393393	6	3#	102.28	145.13	181.43	220.95
393394	10	3#	102.28	145.13	181.43	220.95
393397	30	3#	102.28	145.13	181.43	220.95

50# Laser Label stock (premium white) with no ooze permanent adhesive. (R)
100 label sheets per box.
No bleeds available. Sheet size 8½" x 11".
4-color process available.

0108 Pressure Sensitive Shipping Labels

Label 4" x 3 3/8"
Imprint Area 1/4" x 3"

Format A

Format 0101

Format 0102

Format B

Format 0103

Format 1171

Format C

Format 1181

Format 1191 - Custom
Imprint Size 3 1/2" x 3"

Cat. No.	Labels		Lot Prices			
	per Sheet	Wt. per 100 Sheets	100 Sheets	200 Sheets	300 Sheets	400 Sheets
0108	6	3#	102.28	145.13	181.43	220.95

2-color ink charge \$63.19(R) additional. (R)
*See page 117 for ink color selections for Format 1191.

NOTE:



Includes your company's name, address and phone number in one of four colors! For blank forms, subtract 30%.



! For Shipping Forms, see pages 70-73.

Format D

Gift Certificates

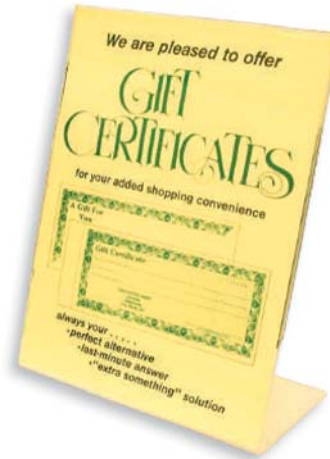
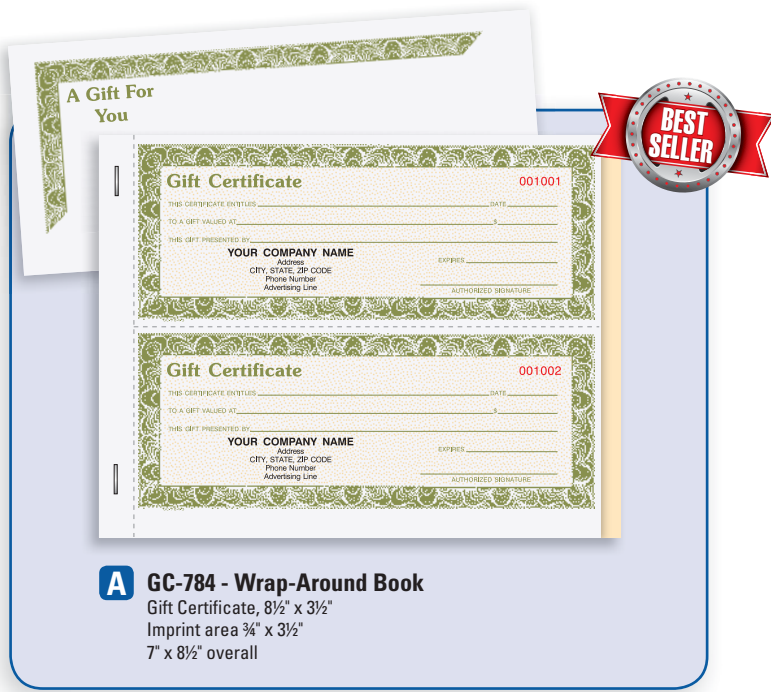

5 Day Shipping



Send your custom artwork or choose one of our predesigned formats.



A GC-784 - Gift Certificate Book

Cat. No.	Pts.	Wt. per 5 Bks	Carbonless Lot Prices			
			5 Bks	10 Bks	15 Bks	20 Bks
GC-784-3	3	12#	152.72	246.12	336.39	414.91

100 Gift Certificates, 50 sheet sets. Envelopes included. (R)

B GCD-784 - Gift Certificate Display

Cat. No.	Wt. each	Price
GCD-784-5	2#	26.16

(R)

C GC-779 - 4-Color Gift Certificate

Cat. No.	Pts.	Wt. per 250 Bks	Imprinted Lot Prices			
			100	250	500	1000
GC-779-1	1	5#	75.30	101.61	135.56	194.84
GC-779-2	2	5#	101.30	136.24	192.71	293.64

Full bleeds available for an additional charge of \$34.02. Specify custom artwork or format choice when ordering. 2-part is white/canary. Envelopes included. (R)

NOTE:



Includes your company's name, address and phone number in one of four colors! For blank forms, subtract 30%.



Colors correspond to sequence and number of parts selected in your order unless otherwise specified.



Choose a six-digit starting number for your imprinted form at no extra charge! Otherwise, we will start with 001001. Four, five and seven-digit numbering available at an additional charge. See page 142 for pricing.



Blank forms will be sequentially numbered unless specified otherwise.

FREE when you order items **D** or **E**

A Gift For You

Envelopes



Counter Top Sign

Keep all your certificates together by binding 50 in a book with a wrap-around cover for a slight additional charge of \$11.42(R) per 1000.



D GC-780-783, GC-785-788 - Snap-A-Part
Gift Certificates, 8½" x 3½"
Imprint area 1" x 4"

D GC-780-783, GC-785-788 - Gift Certificates

Cat. No.	GC-	Color	Pts.	Wt. per 250	Carbonless Lot Prices				
					250	500	100	2000	3000
					Marble Background Colors				
780-2	Blue	2	5#	85.96	125.37	205.97	371.02	535.13	
781-2	Red	2	5#	85.96	125.37	205.97	371.02	535.13	
782-2	Green	2	5#	85.96	125.37	205.97	371.02	535.13	
783-2	Orange	2	5#	85.96	125.37	205.97	371.02	535.13	
					Screened Background Colors				
785-2	Blue	2	5#	85.96	125.37	205.97	371.02	535.13	
786-2	Red	2	5#	85.96	125.37	205.97	371.02	535.13	
787-2	Green	2	5#	85.96	125.37	205.97	371.02	535.13	
788-2	Orange	2	5#	85.96	125.37	205.97	371.02	535.13	

(R)

E GC-790-793 - Gift Certificate Book

Cat. No.	GC-	Color	Pts.	Wt. per 2 Bks	Imprinted Carbonless Lot Prices				
					2(300)	4(600)	6(900)	8(1200)	10(1500)
790-2	Blue	2	4#	115.08	219.08	311.43	394.00	465.24	
791-2	Red	2	4#	115.08	219.08	311.43	394.00	465.24	
792-2	Green	2	4#	115.08	219.08	311.43	394.00	465.24	
793-2	Balloons	2	4#	115.08	219.08	311.43	394.00	465.24	
					Blank Carbonless Lot Prices				
Blank	Blank	2	4#	100.93	192.14	273.88	345.85	408.15	

(R)

NOTE:

Available background options (Item E)

Select from 3 background colors or balloon pattern for gift certificates.



E GC-790-793 - Wire Bound Book
Gift Certificate, 8½" x 11" overall
Certificate size 8½" x 3½"
Imprint area 1" x 4"
150 certificates per book

Calendars & Sticky Notes



A 491275, 491276
Card Calendar, 3½" x 8½"
491275: 4-color/blank
491276: 4-color/black



B 491277
Card Calendar with magnetic back, 8½" x 3½"
4 color

Available with or without the calendar, you choose what you want printed. Just send your artwork and we'll take care of the rest!



C Sticky Notes™
4" x 3" pads
Imprint area 3¾" x 2½"

Add color with a FREE flood coat!



D Sticky Notes™
3" x 3" pads
Imprint area 2½" x 2½"

E Sticky Notes™
3" x 8" pads
Imprint area 2½" x 7½"

Add a magnet to the back of your 3" x 8" notepad for the ultimate convenience! \$.51(R) additional per pad.

7 Day Shipping

A Card Calendars

Cat. No.	per 1000	Wt.		Price Per Piece		
		50	100	200	500	1000
491275	9#	1.77	1.35	1.25	1.04	.83
491276	9#	1.77	1.35	1.25	1.04	.83

(R)

B Card Calendars with Magnet

Cat. No.	per 1000	Wt.		Price Per Piece		
		50	100	200	500	1000
491277	40#	3.43	2.60	2.08	1.56	1.35

(R)

C Bic® Sticky Notes™

Item Number	Size	Wt. per 500 Pads	Pages per Pad	500 per Pad
P4A3A25	4" x 3"	22#	25	0.68
P4A3A50	4" x 3"	44#	50	1.20

Adhesive is on the 4" side. (R)

D Bic® Sticky Notes™

Item Number	Size	Wt. per 500 Pads	Pages per Pad	500 per Pad
P3A3A25	3" x 3"	16#	25	0.68
P3A3A50	3" x 3"	32#	50	1.20

(R)

E Bic® Sticky Notes™

Item Number	Size	Wt. per 500 Pads	Pages per Pad	500 per Pad
P3A8A25	3" x 8"	44#	25	1.66
P3A8A50	3" x 8"	56#	50	3.17

Adhesive is on the 3" side. (R)

Minimum Quantity: 500

Paper Colors: White (Add color with a FREE flood coat.)

Imprint Colors: Black, Red, Yellow, Orange, Light Orange, Navy, Reflex Blue, Blue, Royal, Purple, Plum, Burgundy, Lime, Green, Teal, Forest Green, Magenta, Brown, Cyan, Warm Gray.

Price includes a 4-color process imprint. Converting 4-color process will not guarantee a perfect match to spot color.

Specifications: Text can be as small as 6 point type. Lines must be 0.5 point thick. Floodcoat 10-30% tint recommended. Phantom - 10% tints work best.

- No setup charges.
- No additional charge for phantom (ghost) imprints, flood coating or bleeds.
- Change the paper color on one side by printing a flood coat.

Submit your layout for Custom Punch Cards!

These are great for:

- Beauty Shops & Spas
- Coffee Shops
- Restaurants
- Video/DVD Rentals
- Insurance Agencies
- Pet Stores
- And more...

A 3½" x 2" Punch Cards

Cat. No.	DC-	Pts.	Wt. per 1000	Lot Prices - Black Ink	
				500	1000
4601		1	3#	44.46	48.72

Black ink is standard. Other colors are available at an upcharge. (R)
 Back printing available for \$32.91 (R).
 Printed on 65# White Accent Opaque Card Stock.
 Bleeds available.
 4-color is available for additional charge. 500=\$30.60, 1000=\$61.20 (R).

B Note Pads - 100 Sheets

Cat. No.	NP-	Size	Wt. per 8 Pads	Lot Prices				
				8	16	32	64	128
2000		2¾" x 4¼"	2#	78.05	104.68	160.84	210.34	353.03
2200		4¼" x 5½"	3#	92.82	124.23	209.61	249.55	398.16
2400		5½" x 8½"	5#	110.29	139.20	251.94	409.29	637.05

No bleeds available. (R)

C Note Pads - 50 Sheets

Cat. No.	NP-	Size	Wt. per 8 Pads	Lot Prices				
				8	16	32	64	128
2100		2¾" x 4¼"	1#	57.25	77.12	129.74	154.60	260.68
2300		4¼" x 5½"	2#	68.38	91.78	154.18	183.92	307.68
2500		5½" x 8½"	3#	81.38	102.60	186.11	301.55	470.44

No bleeds available. (R)

NOTE:

Additional PMS Ink Colors

Blue PMS 293	PMS Black PMS 185	Red PMS 185	PMS Reflex Blue	Hunter PMS 336	Maroon PMS 202	Orange PMS 165
Navy PMS 294	Blue PMS 300	Green PMS 347	Brown PMS 463	Burgundy PMS 1955	Gray PMS 430	PMS Yellow

Color other than black \$30.63
 2-Color Combo \$63.19
 Proof \$15.35
 Colors shown are approximate. (R)



Includes your company's name, address and phone number in one of four colors! For blank forms, subtract 30%.



A Punch Cards

3½" x 2"
 Imprint area 1½" x 3"



B Note Pads

100 sheets per pad

C Note Pads

50 sheets per pad

Writing Instruments



BIC® Grip Roller



BIC® Grip Roller Gold

BIC® Grip Roller & Grip Roller Gold Pens

Item Number	Description	Price Per Piece	
		300	500+
GR	Grip Roller	1.32	1.29
GRG	Grip Roller Gold	1.59	1.56

(R)

Ink Colors: Black or Blue - Fine Point.

Pen Colors: White, Navy, Light Gray, Forest Green, Charcoal, Burgundy, Black, (Red & Blue on GR). All pens have black grip.

Imprint Colors: White, Black, Yellow, Navy, Pink, Red, Burgundy, Purple, Teal, Reflex Blue, Process Blue, Maroon, Green, Orange, Charcoal, Brown, Forest Green, Cream, Metallic Silver (except on white barrel).

Imprint Area: 1½" x ⅝" Cap or Barrel.

Choose barrel or cap imprint. If not specified, imprint will be on cap.

Price includes 1-color imprint on cap or barrel. Second color add \$.15(R) per piece.

BIC® Pivo® Twist Action Pens

Item Number	Description	Price Per Piece	
		300	500+
TWP	Pivo®	1.02	1.00

(R)

Ink Colors: Blue or Black. Available in Medium or Fine Point.

Pen Colors: White, Black, Navy, Forest Green, Red, Teal, Purple, Yellow, Burgundy, Blue.

Ring Colors: Black, White, Navy, Red, Yellow, Forest Green, Blue, Burgundy, Teal, Purple. Choose 1 pen & 1 ring color.

Imprint Colors: Black, Brown, Burgundy, Charcoal, Green, Maroon, Navy, Orange, Forest Green, Pink, Process Blue, Purple, Red, Reflex Blue, Teal, White, Yellow, Cream, Metallic Gold, Metallic Silver, Metallic Blue, Metallic Copper, Metallic Green, Metallic Magenta.

Imprint Area: 2" x ¾"

Price includes 1-color imprint on cap or barrel. Second color add \$.15(R) per piece.

Clip Imprint Area: 1" x ⅝"

Add \$.15(R) per piece for clip imprint.



BIC® Pivo®



BIC® Mark-It™

BIC® Mark-It™ Permanent Marker

Item Number	Description	Price Per Piece	
		300	500+
MRPG	Mark-It™ Permanent Marker	1.67	1.54

(R)

Ink Colors: Black or Blue - Fine Point.

Trim/Grip Colors: Black or Blue.

Barrel Colors: White only.

Imprint Colors: Black, Brown, Burgundy, Charcoal, Green, Maroon, Navy, Orange, Forest Green, Pink, Process Blue, Purple, Red, Reflex Blue, Teal, White, Yellow, Cream, Metallic Gold, Metallic Silver, Metallic Blue, Metallic Copper, Metallic Green, Metallic Magenta.

Imprint Area: 1½" x ⅝" Cap or Barrel.

Choose barrel or cap imprint. If not specified, imprint will be on cap.

Price includes 1-color imprint on cap or barrel. Up to 4 colors available on any cap/barrel combination. Add \$.15(R) per marker for each color in second location.

BIC® Brite Liner Grip®

Item Number	Description	Price Per Piece	
		300	500+
BLG	Brite Liner Grip®	1.34	1.23

(R)

Barrel Colors with Matching Ink: Yellow, Pink, Green, Orange, Blue.

All include textured, gray rubber grip & matching clip.

Imprint Colors: Black, Brown, Burgundy, Charcoal, Green, Maroon, Navy, Orange, Forest Green, Pink, Process Blue, Purple, Red, Reflex Blue, Teal, White, Yellow, Cream, Metallic Gold, Metallic Silver, Metallic Blue, Metallic Copper, Metallic Green, Metallic Magenta.

Imprint Area: 1½" x ⅝" Cap or Barrel.

Choose barrel or cap imprint. If not specified, imprint will be on cap. Price includes 1-color imprint on cap or barrel. Second color add \$.15(R) per piece.



BIC® Brite Liner Grip®

BIC® Clic Stic® & Clic Stic® Grip Pens

Item Number	Description	Price Per Piece	
		300	500+
CS	Clic Stic®	0.79	0.76
CSCG	Clic Stic® Grip	1.22	1.18

(R)

Ink Colors: Blue, Black or Red - Medium Point, Black or Blue - Fine Point.

CS **Barrel/Trim Colors:** Clear, Purple, Teal, Red, Black, Silver, Burgundy, Navy, Cream, Blue, Forest Green, Yellow, White, Green, Orange, Pink, Metallic Dark Blue, Metallic Red, Metallic Green, Metallic Brown, Metallic Orange, Metallic Sand.

Barrel Imprint Area: 2 1/8" x 3/4"

CSCG **Barrel Colors:** White Only.

Trim Colors: Black, Blue, Forest Green, Purple, Red, Navy, Pink, Burgundy, Yellow.

Barrel Imprint Area: 1 3/4" x 1/2"

Imprint Colors: Black, Brown, Burgundy, Charcoal, Green, Maroon, Navy, Orange, Forest Green, Pink, Process Blue, Purple, Red, Reflex Blue, Teal, White, Yellow, Cream, Metallic Gold, Metallic Silver, Metallic Blue, Metallic Copper, Metallic Green, Metallic Magenta.

Choose 1 barrel & 1 trim color.

Price includes a 1-color imprint on barrel. Second color add \$.15(R) per piece.

Clip Imprint Area: 1 1/8" x 5/32" Add \$.15(R) per piece for clip imprint.



BIC® Clic Stic®



BIC® Clic Stic® Grip

BIC® Widebody Grip® & Widebody Grip® Color Pens

Item Number	Description	Price Per Piece	
		300	500+
CSWBG	Widebody Grip®	1.67	1.55
CSWBCG	Widebody Grip® Color	1.67	1.55

(R)

Ink Colors: Blue, Black or Red - Medium Point, Blue or Black - Fine Point.

CSWBCG **Barrel Color:** White Only.

Grip and Trim: Black, Purple, Yellow, Red, Blue, Forest Green, Orange, Pink, Navy, Burgundy (Grip and Trim must be the same color).

CSWBG **Barrel/Trim Colors:** Silver (Barrel only), Black, White, Navy, Cream, Yellow, Teal, Blue, Red, Forest Green, Purple, Burgundy.

Grip: Black Only.

Choose 1 barrel & 1 trim color.

Imprint Colors: Black, Brown, Burgundy, Charcoal, Green, Maroon, Navy, Orange, Forest Green, Pink, Process Blue, Purple, Red, Reflex Blue, Teal, White, Yellow, Cream, Metallic Gold, Metallic Silver, Metallic Blue, Metallic Copper, Metallic Green, Metallic Magenta.

Barrel Imprint Areas:

Option 1: 2 1/8" x 5/8" Barrel imprint on opposite side of clip.

Option 2: 1 1/8" x 1" Barrel imprint aligned with clip, when there is a clip imprint.

Price includes 1-color imprint on barrel. Second color add \$.15(R) per piece.

Clip Imprint Area: 3/4" x 5/32" Add \$.15(R) per piece for clip imprint.



BIC® Widebody Grip®



BIC® Widebody Grip® Color

BIC® Velocity® Gel

Item Number	Description	Price Per Piece		
		150	300	500+
VGEL	Velocity® Gel	2.44	2.28	2.11

(R)

Barrel Colors: Black or Blue.

Barrel matches the ink color.

Ink Colors: Black or Blue Gel Ink - Medium Point.

Barrel Imprint Area: 1 3/4" x 7/16" Add \$.15(R) per piece for a second color.

Imprint Colors: Black, Brown, Burgundy, Charcoal, Green, Maroon, Navy, Orange, Forest Green, Pink, Process Blue, Purple, Red, Reflex Blue, Teal, White, Yellow, Cream, Metallic Gold, Metallic Silver, Metallic Blue, Metallic Copper, Metallic Green, Metallic Magenta.

Price includes 1-color imprint on barrel.



BIC® Velocity® Gel

NOTE:



! Allow 3 extra days for proof.

Writing Instruments



BIC® Style®



BIC® Style® Clear

BIC® Style® & Style® Clear

Item Number	Description	Price Per Piece	
		500+	
STYL	Style®	0.47	
STYLCL	Style® Clear	0.52	

(R)

Ink Colors: Black ink - Medium Ballpoint.

Colors:

STYL Cap Colors: Black, Blue, Green, Red. All include a white barrel.

STYLCL Pen Colors: Blue, Green, Purple, Red. Cap matches barrel color.

Imprint Area: Barrel: 2¼" x ¾"

Imprint Colors: Black, Brown, Burgundy, Charcoal, Green, Maroon, Navy, Orange, Forest Green, Pink, Process Blue, Purple, Red, Reflex Blue, Teal, White, Yellow, Cream, Metallic Gold, Metallic Silver, Metallic Blue, Metallic Copper, Metallic Green, Metallic Magenta.

Note: Price includes a 1-color imprint on barrel. Second color add \$.15(R) per piece.



BIC® Protrusion Grip™

BIC® Protrusion Grip™

Item Number	Description	Price Per Piece	
		50	250+
PG	Protrusion Grip™	7.12	7.01

(R)

Ink Colors: Black ink - Medium Ballpoint.

Barrel Colors: Copper, Black, Blue, Silver. All include polished chrome plated trim and clip.

Imprint Area: Barrel Screen Printing: 1⅞" x ½", opposite clip.

Screen printing price includes 1 color barrel imprint.

Imprint Colors: Black, Brown, Burgundy, Charcoal, Green, Maroon, Navy, Orange, Forest Green, Pink, Process Blue, Purple, Red, Reflex Blue, Teal, White, Yellow, Cream, Metallic Gold, Metallic Silver, Metallic Blue, Metallic Copper, Metallic Green, Metallic Magenta.

Note: Black velour sleeve included.



BIC® Pencil Solid

BIC® Pencil Solid

Item Number	Description	Price Per Piece	
		500+	
BPS	Wooden Pencil Solid	0.32	

(R)

Barrel Colors: Red, Blue, Neon Green, Yellow, Black, Orange, Navy, Silver, Purple, White, Pink.

Specifications: Pencil has a gold ferrule, white eraser & #2 Graphite lead.

Barrel Imprint Area: 4" x ¾"

Additional Ink Color: Add \$.15(R) per piece for second imprint color.

Imprint Colors: White, Black, Red, Yellow, Orange, Pink, Navy, Reflex Blue, Process Blue, Purple, Burgundy, Maroon, Green, Teal, Forest Green, Brown, Charcoal, Cream, Metallic Blue, Metallic Green, Metallic Gold, Metallic Magenta, Metallic Copper, Metallic Silver.



BIC® Media Clic™ Grip

BIC® Media Clic™ & Media Clic™ Grip

Item Number	Description	Price Per Piece	
		300	500+
MC	Media Clic™	0.75	0.73
MCG	Media Clic™ Grip	1.04	0.97

(R)

Ink Colors: Black or Blue ink. Medium Ballpoint.

Barrel/Trim Colors:

Media Clic: Black, Forest Green, Light Blue, Navy, Pink, Red, Silver, Yellow, White. (Choose 1 barrel & 1 trim color)

Media Clic Grip: Black, Forest Green, Light Blue, Navy, Pink, Red, Yellow.

Media Clic Grip White Barrel only.

Imprint Area: Barrel: 2⅞" x ¾", Clip: ⅝" x ⅝"

Imprint Colors: Black, Brown, Burgundy, Charcoal, Green, Maroon, Navy, Orange, Forest Green, Pink, Process Blue, Purple, Red, Reflex Blue, Teal, White, Yellow, Cream, Metallic Gold, Metallic Silver, Metallic Blue, Metallic Copper, Metallic Green, Metallic Magenta.

Note: Price includes a 1-color imprint on barrel. Second & third color add \$.15(R) per piece.



BIC® Media Clic™

BIC® Mechanical Pencils

Item Number	Description	Price Per Piece	
		300	500+
PMRCG	Matic Grip®	1.36	1.33
PMRMC	Media Clic™	1.19	1.10

(R)

PMRCG Lead/Erasers: .7mm Lead, White Erasers.
Barrel Colors: White.
Trim/Grip Colors: Forest Green, Blue, Black or Red.
Clip Imprint Area: 1" x 1/8", Add \$.15(R) per piece for clip imprint.
Barrel Imprint Area: 1 1/2" x 1/2"
 Add \$.15(R) per piece for second imprint color.
 Price includes 3 - .7mm #2 graphite leads.

PMRMC Lead/Erasers: .7mm Lead, White Erasers.
Barrel Colors: Black, Navy or White.
Clip Imprint Area: 1 5/16" x 5/32", Add \$.15(R) per piece for clip imprint.
Barrel Imprint Area: 2 1/8" x 3/4"
 Add \$.15(R) per piece for second imprint color.
 Price includes 1 - .7mm #2 graphite lead.

Imprint Colors: Black, Brown, Burgundy, Charcoal, Green, Maroon, Navy, Orange, Forest Green, Pink, Process Blue, Purple, Red, Reflex Blue, Teal, White, Yellow, Cream, Metallic Gold, Metallic Silver, Metallic Blue, Metallic Copper, Metallic Green, Metallic Magenta.



BIC® Matic Grip®



BIC® Media Clic™

BIC® Round Stic® Pens

Item Number	Description	Price Per Piece	
		300	500+
RS	Round Stic®	0.56	

(R)

Ink Colors: Blue or Black - Fine Point, Blue, Black, Red or Purple - Medium Point.
Barrel/Trim Colors: Clear, Purple, Teal, Red, Black, Silver, Burgundy, Navy, Blue, Cream, Forest Green, Yellow, White, Pink, Orange, Green, Metallic Dark Blue, Metallic Green, Metallic Orange, Metallic Red.
 Choose 1 barrel & 1 trim color.

Imprint Colors: Black, Brown, Burgundy, Charcoal, Green, Maroon, Navy, Orange, Forest Green, Pink, Process Blue, Purple, Red, Reflex Blue, Teal, White, Yellow, Cream, Metallic Gold, Metallic Silver, Metallic Blue, Metallic Copper, Metallic Green, Metallic Magenta.

Barrel Imprint Area: 2 1/2" x 3/4"
 Price includes a 1-color imprint on barrel. Second color add \$.15(R) per piece.



BIC® Round Stic®

BIC® Tri-Stic® & Tri-Stic® Clear Pens

Item Number	Description	Price Per Piece	
		300	500+
TS	Tri-Stic®	0.96	0.92
TSCL	Tri-Stic® Clear	1.13	1.10

(R)

Ink Colors: TS: Black or Blue - Fine Point.
 TSCL: Black, Blue or Red - Medium Point.
TS Barrel/Trim Colors: Navy, Black, Forest Green, Blue, Yellow, Red, Teal, Cream, Purple, White, Green, Orange, Burgundy, Pink.

TSCL Clear Barrel Colors: Pink, Blue, Orange, Green, Purple, Clear, Black, Royal Blue, Red. **Trim Colors:** Transparent White Ice Only.

Imprint Colors: Black, Brown, Burgundy, Charcoal, Green, Maroon, Navy, Orange, Forest Green, Pink, Process Blue, Purple, Red, Reflex Blue, Teal, White, Yellow, Cream, Metallic Gold, Metallic Silver, Metallic Blue, Metallic Copper, Metallic Green, Metallic Magenta.

Imprint Area: 3" x 7/32" per panel
 Copy and imprint color may be different on each side at no additional cost.
Clip Imprint Area: 1 1/8" x 5/32" Add \$.15(R) per piece for clip imprint.

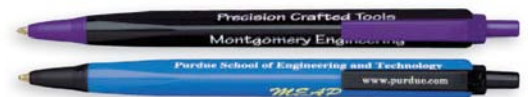

BIC® Tri-Stic®



BIC® Tri-Stic® Clear

NOTE:



Allow 3 extra days for proof.

Self Inking Stamps



NOT FOR PUBLICATION

Impression Area: 1½" x ⅝" (41mm x 16mm)

Mara Beth Stevens
1234 West End Drive
Chicago, IL 60611
312-555-1212

Impression Area: 2⅝" x ¾" (61mm x 20mm)

PAY TO THE ORDER OF
1ST LOCAL BANK AND TRUST
E. GRAND STREET BRANCH
FOR DEPOSIT ONLY
CLASSIC EDITION, INC.
ACCT. #123-45-678

Impression Area: 2½" x 1" (65mm x 25mm)



**HANDLE WITH CARE!
DO NOT X-RAY
COMPUTER DISCS**

Impression Area: 3" x 1½" (77mm x 39mm)



Received
Jan 19, 2014
Simply Sara's Clothing

Impression Area: 1½" x 1" (41mm x 24mm)

A Ideal 4911 Self Inking Stamps

Cat No.	Item	Size	Ink	Price
320009	Ideal 4911	1½" x ⅝"	Black	33.96
320013	Ideal 4911	1½" x ⅝"	Red	33.96

Maximum 3 lines of copy. (R)
Free bottle of ink included.

B Ideal 4913 Self Inking Stamps

Cat No.	Item	Size	Ink	Price
320010	Ideal 4913	2⅝" x ¾"	Black	36.14
320014	Ideal 4913	2⅝" x ¾"	Red	36.14

Maximum 4 lines of copy. (R)
Free bottle of ink included.

C Ideal 4914 Self Inking Stamps

Cat No.	Item	Size	Ink	Price
320011	Ideal 4914	2½" x 1"	Black	38.01
320015	Ideal 4914	2½" x 1"	Red	38.01

Maximum 7 lines of copy. (R)
Free bottle of ink included.

D Ideal 4926 Self Inking Stamps

Cat No.	Item	Size	Ink	Price
320012	Ideal 4926	3" x 1½"	Black	40.09
320016	Ideal 4926	3" x 1½"	Red	40.09

Maximum 9 lines of copy. (R)
Free bottle of ink included.

E Self Inking Date Stamps

Cat No.	Item	Price
320017	Date Stamp Only	34.58
320018	Date Stamp "Paid"	47.06
320019	Date Stamp "Received"	47.06
320020	Date Stamp "Faxed"	47.06

Black ink only. (R)

NOTE:



! Impressions are customizable with your info.

Forms That Work For Your Business.

Use these three easy steps to place your order:

- Step 1** - Choose the sales book size
- Step 2** - Determine parts needed
- Step 3** - Send us your camera-ready art

To personalize your sales book, add a custom or stock logo. Choose up to two colors to complete your book.

Back printing and part-to-part art changes are not available.

All original – each part is individually printed.

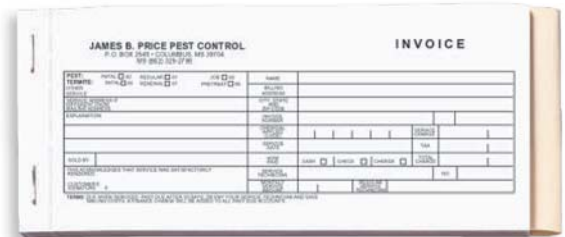
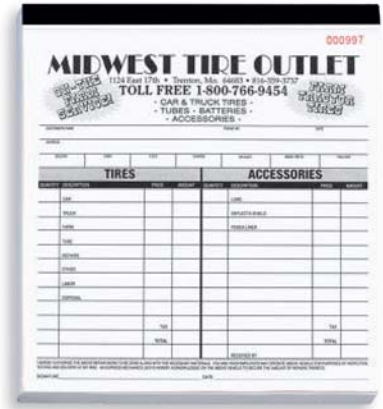

2-Part Carbonless - Stitched - 50 Sets Per Book

Cat. No.	Size	Last Pt. Perfed	Book Constr.	Pts.	Wt. 10 Bks	Carbonless Lot Prices				
						10 Bks	20 Bks	25 Bks	50 Bks	100 Bks
DFCSB-828-2	3½" x 8½"	Yes	Economy	2	4#	119.09	175.39	209.66	396.83	744.14
DFMB-034-2	5½" x 8½"	No	Manifold	2	5#	149.07	261.17	306.05	562.17	1,019.13
DFCSB-827-2	5½" x 8½"	Yes	Economy	2	5#	145.71	258.32	302.48	555.03	1,004.65
DFMB-063-2	8½" x 7"	No	Manifold	2	7#	162.84	265.56	304.73	559.42	1,091.45
DFMB-037-2	8½" x 8½"	No	Manifold	2	8#	169.17	266.07	308.50	587.86	1,124.09
DFMB-036-2	8½" x 11"	No	Manifold	2	9#	172.84	274.53	311.46	595.83	1,136.84
DFMB-020-2	8½" x 14"	No	Manifold	2	10#	197.52	313.70	365.31	678.35	1,318.61

(R)

3-Part Carbonless - Stitched - 50 Sets Per Book

Cat. No.	Size	Last Pt. Perfed	Book Constr.	Pts.	Wt. 10 Bks	Carbonless Lot Prices				
						10 Bks	20 Bks	25 Bks	50 Bks	100 Bks
DFCSB-828-3	3½" x 8½"	Yes	Economy	3	6#	130.71	204.97	227.41	438.04	826.76
DFMB-034-3	5½" x 8½"	No	Manifold	3	8#	160.60	284.02	327.27	610.83	1,128.58
DFCSB-827-3	5½" x 8½"	Yes	Economy	3	8#	155.60	278.31	322.27	602.06	1,099.41
DFMB-063-3	8½" x 7"	No	Manifold	3	10#	200.89	336.65	397.95	732.00	1,427.75
DFMB-037-3	8½" x 8½"	No	Manifold	3	12#	206.91	346.55	402.14	754.04	1,471.30
DFMB-036-3	8½" x 11"	No	Manifold	3	13#	212.93	356.54	407.03	777.60	1,500.68
DFMB-020-3	8½" x 14"	No	Manifold	3	15#	244.34	408.26	477.41	889.29	1,727.83

(R)



Special Feature Prices

Cat.No.	Quantity Lot Prices				
	5Bks	10Bks	20Bks	25Bks	50Bks 100Bks
Numbering on Imprinted Forms/Books					
310025	13.17	13.17	18.16	35.74	52.88 88.13
2-Hole Punch					
310050	23.94	23.94	23.94	28.37	32.67 38.13
3-Hole Punch					
310056	37.78	37.78	37.78	42.32	46.97 55.82
Heavy/Full Custom Composition					
310020	156.58 all quantities				
Medium Composition Changes/Deletions					
310015	63.31 all quantities				
Light Composition					
310014	24.16 all quantities				
Fax Proof					
310007	15.32 per proof				

(R)

NOTE:

Book Construction

- Manifold**
- Front Flap
 - White Stock
 - Wrap-around Flap
 - Stitched & Taped (Black)
- Economy**
- No Front Flap
 - Manila Stock
 - Wrap-around Flap
 - Stitched, No Tape

Maximum Imprint Area

Form Size	Imprint Size
3½" x 8½"	3½" x 8"
5½" x 8½"	5" x 8"
8½" x 7"	8" x 6½"
8½" x 8½"	8" x 8"
8½" x 11"	8" x 10½"
8½" x 14"	8" x 13½"



! Ready-To-Go Formats, see pages 130-131.

! Envelopes available, see page 100.

Custom Multiform Books

Whether stitched or wire bound, a multiform book adds convenience and reduces the number of lost forms. You can also add a custom cover for a professional look. Use one of our convenient Ready-to-Go formats or submit your custom art to make your book exactly what you need.

Design The Perfect Cover.

Once you have decided what you need in a book and how you want it bound, you can design the cover.

Covers are printed in Black ink. If you want your cover printed in another color, we can do that for you at an additional charge. 4-color process is available for an additional charge of \$30(R) for 500 [sheets] and \$60(R) for 1,000 [sheets].

Custom Book Covers are only available on stitched, wire bound and manifold books. No close registration and printing is one side only.

Custom Book Covers

1-100 Bks	101-200 Bks	201-300 Bks	301-400 Bks	401-500 Bks
121.13	130.41	139.79	148.97	158.87

(R)



Ordering Is Easy!

Choose:

- Number of forms per page: 2 to 8
- Type of book binding: Wire, Stitched, Economy
- Starting number
- Ink color
- Format: Ready-To-Go or Custom Art
- Optional special features
- Optional cover

Binding

Stitched

- Side-stitched for durability
- Heavy duty wire staples
- Wrap around flap
- Attractive matte black spine tape
- White stock front cover
- Economical

Wire

- Book lays flat when opened
- Plastic-coated heavy gauge wire
- Won't "spring" like spiral binding
- Includes wrap-around cover with flyleaf
- White stock front cover
- Top of the line

Economy

- Same as Wire, but with insert sheet instead of wrap-around cover.

Ink Choices for forms and covers

The standard is black ink but you can choose more than one color or a color other than black.

Blue PMS 293	PMS Black	Red PMS 185	PMS Reflex Blue	Hunter PMS 336	Maroon PMS 202	Orange PMS 165
Navy PMS 294	Blue PMS 300	Green PMS 347	Brown PMS 463	Burgundy PMS 1955	Gray PMS 430	PMS Yellow

Color Other Than Black \$30.63

2-Color Combo \$63.19

Proof \$15.35

Colors shown are approximate. (R)

No bleeds.

Special Feature Prices

Cat.No.	Quantity Lot Prices					
	5Bks	10Bks	20Bks	25Bks	50Bks	100Bks
Numbering on Imprinted Forms/Books						
310025	13.17	13.17	18.16	35.74	52.88	88.13
2-Hole Punch						
310050	23.94	23.94	23.94	28.37	32.67	38.13
3-Hole Punch						
310056	37.78	37.78	37.78	42.32	46.97	55.82
Heavy/Full Custom Composition						
310020	156.58 all quantities					
Medium Composition Changes/Deletions						
310015	63.31 all quantities					
Light Composition						
310014	24.16 all quantities					
Fax Proof						
310007	15.32 per proof					

(R)

Custom Multiform Books

Three-On-A-Page Books

Shown in Ready-To-Go Formats

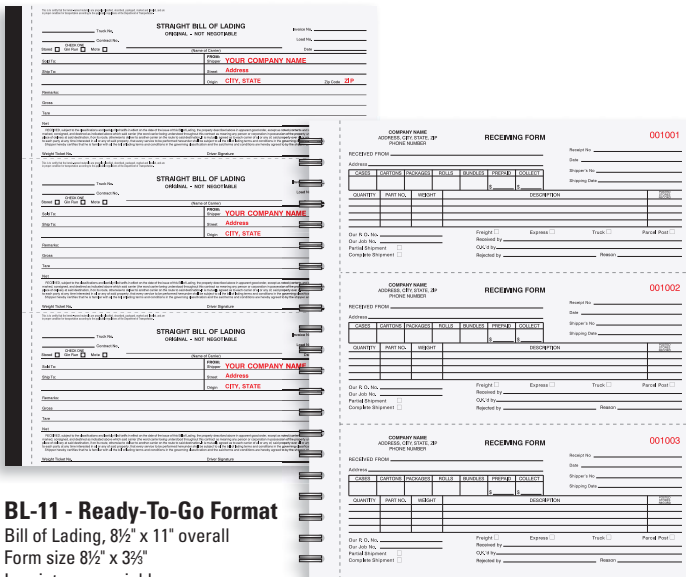

BL-11 - Ready-To-Go Format

Bill of Lading, 8½" x 11" overall
Form size 8½" x 3¾"
Imprint area variable

RF-13 - Ready-To-Go Format

Receiving Form, 8½" x 11" overall
Form size 8½" x 3¾"
Imprint area ½" x 2¾"

Sizes

Overall Size	8½" x 11"
Form Size	8½" x 3¾"
Maximum Print Area	8" x 3"



DFCWB-027 Stretched Book*

Overall: 9½" x 8¼"
Form size 8½" x 2¾"
Imprint area 2½" x 8"

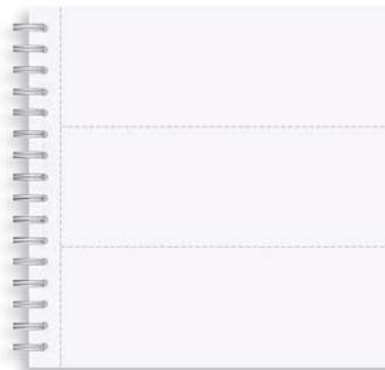

DFCWB-028 Wire Bound Book*

Overall: 9¼" x 8¼"
Form size 8½" x 2¾"
Imprint area 2½" x 8"

*Special sizes.

NOTE:



Colors correspond to sequence and number of parts selected in your order unless otherwise specified.



2-Part Carbonless

Cat. No.	# Sheet	# Receipts	Bind	Last Pt. Perfed	Pts.	Wt. 5 Bks	Carbonless Lot Prices				
							5 Bks	10 Bks	25 Bks	50 Bks	100 Bks
066-2	50	150	Stitched	No	2	8#	99.71	148.26	297.69	568.50	1,073.30
068-2	50	150	Wire	No	2	8#	115.52	180.18	377.45	713.85	1,391.54
060-2	63	189	Stitched	No	2	8#	129.90	195.18	395.91	740.06	1,434.99
062-2	63	189	Wire	No	2	8#	145.40	226.80	475.68	899.49	1,753.53
826-2	75	225	Economy	No	2	10#	170.60	266.27	554.01	1,058.20	--
886-2	75	225	Economy	Yes	2	10#	170.60	266.27	554.01	1,058.20	--
027-2	50*	150	Stitched	No	2	7#	94.61	140.91	282.80	540.14	1,019.64
028-2	50*	150	Wire	No	2	7#	109.70	171.21	358.58	678.15	1,321.87

*Note: Different form and overall size.

(R)

3-Part Carbonless

Cat. No.	# Sheet	# Receipts	Bind	Last Pt. Perfed	Pts.	Wt. 5 Bks	Carbonless Lot Prices				
							5 Bks	10 Bks	25 Bks	50 Bks	100 Bks
066-3	50	150	Stitched	No	3	9#	157.64	241.18	488.73	923.15	1,791.48
068-3	50	150	Wire	No	3	9#	173.66	272.80	568.29	1,082.17	2,109.92
826-3	50	150	Economy	No	3	10#	171.31	268.01	558.20	1,066.46	--
886-3	50	150	Economy	Yes	3	10#	171.31	268.01	558.20	1,066.46	--
060-3	42	126	Stitched	No	3	9#	130.10	197.32	397.95	750.36	1,453.14
062-3	42	126	Wire	No	3	9#	145.91	229.04	477.51	909.48	1,771.49
027-3	50*	150	Stitched	No	3	8#	149.79	229.04	464.36	876.95	1,701.92
028-3	50*	150	Wire	No	3	8#	165.09	259.13	539.94	1,028.01	2,004.35

*Note: Different form and overall size.

(R)

4-Part Carbonless

Cat. No.	# Sheet	# Receipts	Bind	Last Pt. Perfed	Pts.	Wt. 5 Bks	Carbonless Lot Prices			
							5 Bks	10 Bks	25 Bks	50 Bks
826-4	50	150	Economy	No	4	14#	215.78	338.69	704.77	1,346.35

(R)

Four-On-A-Page Books

RB-14 - Ready-To-Go Format
 Receipt Book, 8½" x 11" overall
 Form size 8½" x 2¾"
 Imprint area ½" x 4"

PO-14 - Ready-To-Go Format
 Purchase Order, 8½" x 11" overall
 Form size 8½" x 2¾"
 Imprint area ½" x 4"

PO-24 - Ready-To-Go Format
 Purchase Order, 8½" x 11" overall
 Form size 8½" x 2¾"
 Imprint area ½" x 4"

Sizes

Overall Size	8½" x 11"
Form Size	8½" x 2¾"
Maximum Print Area	8" x 2½"

2-Part Carbonless

Cat. No.	# Sheet	# Receipts	Last Pt.	Perfed	Pts.	Wt.	Carbonless Lot Prices				
							5 Bks	5 Bks	10 Bks	25 Bks	50 Bks
083-2	50	200	Stitched	No	2	8#	99.71	148.26	297.69	568.50	1,073.30
088-2	50	200	Wire	No	2	8#	115.52	180.18	377.45	713.85	1,391.54
070-2	63	252	Stitched	No	2	8#	129.90	195.18	395.91	740.06	1,434.99
072-2	63	252	Wire	No	2	8#	145.40	226.80	475.68	899.49	1,753.53
824-2	75	300	Economy	No	2	10#	170.60	266.27	554.01	1,058.20	--
884-2	75	300	Economy	Yes	2	10#	170.60	266.27	554.01	1,058.20	--

(R)

3-Part Carbonless

Cat. No.	# Sheet	# Receipts	Last Pt.	Perfed	Pts.	Wt.	Carbonless Lot Prices				
							5 Bks	5 Bks	10 Bks	25 Bks	50 Bks
083-3	50	200	Stitched	No	3	9#	157.64	241.18	488.73	923.15	1,791.48
088-3	50	200	Wire	No	3	9#	173.66	272.80	568.29	1,082.17	2,109.92
824-3	50	200	Economy	No	3	10#	171.31	268.01	558.20	1,066.46	--
884-3	50	200	Economy	Yes	3	10#	171.31	268.01	558.20	1,066.46	--
070-3	42	168	Stitched	No	3	9#	130.10	197.32	397.95	750.36	1,453.14
072-3	42	168	Wire	No	3	9#	145.91	229.04	477.51	909.48	1,771.49

(R)

4-Part Carbonless

Cat. No.	# Sheet	# Receipts	Last Pt.	Perfed	Pts.	Wt.	Carbonless Lot Prices				
							5 Bks	5 Bks	10 Bks	25 Bks	50 Bks
824-4	50	200	Economy	No	4	14#	226.70	355.52	739.96	1,413.77	

(R)

NOTE:

- ! See page 124 for special feature prices and ink colors.
- ! All formats available with stitched or wire binding.
- ! Design perfect cover, see page 124.

Custom Multiform Books

Six-On-A-Page, Eight-On-A-Page

Ordering Is Easy!

Choose:

- Number of forms per page
- Type of book binding
- Starting number
- Ink color
- Ready-To-Go style or submit your custom art
- Provide imprint information

Sizes Six-On-A-Page

Overall Size	11" x 9½"
Form Size	4¾" x 3⅜"
Maximum Print Area	4½" x 3"

Sizes Eight-On-A-Page

Overall Size	11" x 9½"
Form Size	4¾" x 2¾"
Maximum Print Area	4½" x 2⅞"



PO-16 - Ready-To-Go Format
Purchase Order, 11" x 9½" overall
Form size 4¾" x 3⅜"
Imprint area 1" x 2"

PO-18 - Ready-To-Go Format
Purchase Order, 11" x 9½" overall
Form size 4¾" x 2¾"
Imprint area ½" x 2¼"

2-Part Carbonless - Six-On-A-Page

Cat. No.	# Sheet	# Receipts	Last Pt.	Wt.	Carbonless Lot Prices						
					5 Bks	5 Bks	10 Bks	25 Bks	50 Bks	100 Bks	
090-2	83	498	Stitched	No	2	9#	175.90	266.99	546.98	1,025.87	1,991.50
092-2	83	498	Wire	No	2	9#	191.81	298.91	626.64	1,185.09	2,309.94

(R)

3-Part Carbonless - Six-On-A-Page

Cat. No.	# Sheet	# Receipts	Last Pt.	Wt.	Carbonless Lot Prices						
					5 Bks	5 Bks	10 Bks	25 Bks	50 Bks	100 Bks	
090-3	56	336	Stitched	No	3	10#	178.65	273.72	557.07	1,053.20	2,043.62
092-3	56	336	Wire	No	3	10#	194.57	305.75	636.74	1,212.32	2,362.47

(R)

2-Part Carbonless - Eight-On-A-Page

Cat. No.	# Sheet	# Receipts	Last Pt.	Wt.	Carbonless Lot Prices						
					5 Bks	5 Bks	10 Bks	25 Bks	50 Bks	100 Bks	
095-2	83	664	Stitched	No	2	9#	175.90	266.99	546.98	1,025.87	1,991.50
097-2	83	664	Wire	No	2	9#	191.81	298.91	626.64	1,185.09	2,309.94

(R)

3-Part Carbonless - Eight-On-A-Page

Cat. No.	# Sheet	# Receipts	Last Pt.	Wt.	Carbonless Lot Prices						
					5 Bks	5 Bks	10 Bks	25 Bks	50 Bks	100 Bks	
095-3	56	448	Stitched	No	3	10#	178.65	273.72	557.07	1,053.20	2,043.62
097-3	56	448	Wire	No	3	10#	194.57	305.75	636.74	1,212.32	2,362.47

(R)

NOTE:



Colors correspond to sequence and number of parts selected in your order unless otherwise specified.



NOTE:

- ! See page 124 for special feature prices, ink colors and book binding.
- ! All formats available with stitched or wire binding.
- ! Back printing and part-to-part changes are not available.

Predesigned Layout Options

YOUR COMPANY NAME
Address
CITY, STATE, ZIP CODE
Phone Number
Advertising Line

CHANGE ORDER
001001

TO:	PHONE:	DATE:
JOB NUMBER/ORDER:		
JOB LOCATION:		
PRINTING CONTRACT NUMBER:	PRINTING CONTRACT DATE:	JOB ESTIMATOR:
		JOB PHONE:

I hereby agree to make the changes specified above at this total price.

DATE:	PRINTING CONTRACT AMOUNT:	5
PRINTING CONTRACT TOTAL:		5

NOTE: This Change Order becomes part of and in conformance with the existing contract.

WE AGREE: hereby to make the changes specified above at this total price.

ACCEPTED - The above prices and specifications of the Change Order are satisfactory and are hereby accepted. All work is to be performed under the same terms and conditions as specified in the original contract unless otherwise specified.

CO-21
Change Order
Form size 8½" x 14"
Imprint area 1" x 4"

CO-11
Change Order
Form size 8½" x 11"
Imprint area 1" x 4"

YOUR COMPANY NAME
Address
CITY, STATE, ZIP CODE
Phone Number
Advertising Line

INVOICE
001001

DATE:	DATE:
S O L D T O	S H I P T O

QUANTITY	DESCRIPTION	UNIT PRICE	AMOUNT

YOUR COMPANY NAME
Address
CITY, STATE, ZIP CODE
Phone Number
Advertising Line

INVOICE
001001

DATE:	DATE:
S O L D T O	S H I P T O

QUANTITY	DESCRIPTION	UNIT PRICE	AMOUNT

Thank You

IN-31
Invoice
Form size 8½" x 11"
Imprint area 1" x 4"

IN-21
Invoice
Form size 8½" x 8½"
Imprint area 1" x 4"

IN-11
Invoice
Form size 8½" x 7"
Imprint area 1" x 4"

NOTE:

Ordering Is Easy!

Choose:

- Number of forms per page: 2 to 8
- Type of book binding: Wire, Stitched, Economy
- Starting number
- Ink color
- Format: Ready-To-Go or Custom Art
- Optional special features
- Optional cover
- See page 123, 132 & 133 for pricing

Binding

Stitched

- Side-stitched for durability
- Heavy duty wire staples
- Wrap around flap
- Attractive matte black spine tape
- White stock front cover
- Economical

Wire

- Book lays flat when opened
- Plastic-coated heavy gauge wire
- Won't "spring" like spiral binding
- Includes wrap-around cover with flyleaf
- White stock front cover
- Top of the line

Economy

- Same as Wire, but with insert sheet instead of wrap-around cover.

Ink Choices for forms and covers

The standard is black ink but you can choose more than one color or a color other than black.

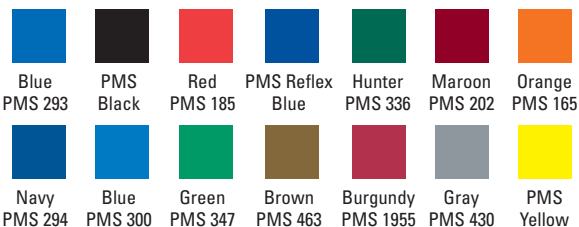

Color Other Than Black	\$30.63
Two Color Combo	\$63.19
Proof	\$15.35

Colors shown are approximate. (R)
No bleeds.



Colors correspond to sequence and number of parts selected in your order unless otherwise specified.



Design The Form You Need

Can't find a stock form that works for your business?

Design your own with the columns, lines and spaces you need. Add your company logo or use one of our stock logos (see pages 134-136) and choose up to two PMS colors for your form for an additional charge. See page 130.

Back printing and part-to-part changes are not available. Available without stub. Please request this option when placing your order. All original - each part is individually printed.

Custom Register Forms Available. Call for Pricing.

NOTE:

Maximum Imprint Area

Form Size	Imprint Size
4¼" x 7"	3¾" x 6½"
5½" x 8½"	5" x 8"
8½" x 7"	8" x 6½"
8½" x 8½"	8" x 8"
8½" x 11"	8" x 10½"
8½" x 14"	8" x 13½"
11" x 8½"	10½" x 8"

See page 124 for additional charges.



Colors correspond to sequence and number of parts selected in your order unless otherwise specified.



1-Part Laser

Cat. No.	Size	Pts.	Wt. per 1000	Carbonless Lot Prices				
				250	500	1000	2000	5000
DFCSF-829-1	8½" x 11"	1	11#	93.48	124.70	196.10	337.26	818.30

(R)

2-Part Carbonless - Snap-A-Part

Cat. No.	Size	Last Pt. Perf	Last Pt. Tag	Pts.	Wt. per 1000	Carbonless Lot Prices				
						250	500	1000	2000	5000
DFCSF-823-2	4¼" x 7"	Yes	No	2	8#	85.22	111.03	171.41	291.36	626.74
DFPC-089-2	5½" x 8½"	Yes	No	2	10#	107.25	142.95	227.41	415.80	1,009.44
DFPC-099-2	8½" x 7"	Yes	No	2	13#	117.05	156.11	245.87	422.84	1,025.76
DFPC-023-2	8½" x 8½"	Yes	No	2	14#	120.72	160.91	253.22	435.80	1,056.47
DFPC-069-2*	8½" x 11"	Yes	No	2	16#	124.70	166.01	261.58	450.08	1,090.74
DFCSF-889-2	8½" x 11"	Yes	Yes	2	25#	136.83	182.73	287.79	494.85	1,200.39
DFPC-079-2	8½" x 14"	Yes	No	2	19#	143.16	191.00	300.65	517.40	1,255.16
DFPC-029-2	11" x 8½"	Yes	No	2	16#	149.69	199.26	313.91	540.04	1,308.81

(R)

*Also available as DFCSF-829-2 item number.

3-Part Carbonless - Snap-A-Part

Cat. No.	Size	Last Pt. Perf	Last Pt. Tag	Pts.	Wt. per 1000	Carbonless Lot Prices				
						250	500	1000	2000	5000
DFCSF-823-3	4¼" x 7"	Yes	No	3	12#	94.40	130.20	209.25	367.15	835.02
DFPC-089-3	5½" x 8½"	Yes	No	3	16#	113.78	151.83	274.53	498.32	1,118.99
DFPC-099-3	8½" x 7"	Yes	No	3	19#	145.91	194.57	323.29	560.75	1,360.02
DFPC-023-3	8½" x 8½"	Yes	No	3	22#	150.30	200.38	332.78	577.68	1,400.10
DFPC-069-3*	8½" x 11"	Yes	No	3	25#	155.30	206.91	343.69	596.55	1,446.62
DFCSF-889-3	8½" x 11"	Yes	Yes	3	35#	170.80	227.41	378.17	611.64	1,483.03
DFPC-079-3	8½" x 14"	Yes	No	3	29#	178.35	237.92	395.20	685.90	1,663.57
DFPC-029-3	11" x 8½"	Yes	No	3	25#	186.30	248.01	412.44	715.89	1,735.89

(R)

*Also available as DFCSF-829-3 item number.

4-Part Carbonless - Snap-A-Part

Cat. No.	Size	Last Pt. Perf	Last Pt. Tag	Pts.	Wt. per 1000	Carbonless Lot Prices				
						250	500	1000	2000	5000
DFPC-089-4	5½" x 8½"	Yes	No	4	22#	121.33	161.72	298.61	537.59	1,239.25
DFPC-099-4	8½" x 7"	Yes	No	4	25#	173.35	231.08	396.73	730.88	1,772.81
DFPC-023-4	8½" x 8½"	Yes	No	4	30#	178.45	238.12	408.46	752.91	1,825.24
DFPC-069-4*	8½" x 11"	Yes	No	4	32#	184.16	245.57	422.03	777.19	1,884.81
DFCSF-889-4	8½" x 11"	Yes	Yes	4	43#	202.93	270.45	463.95	855.32	2,073.51
DFPC-079-4	8½" x 14"	Yes	No	4	39#	212.01	282.59	485.47	893.98	2,176.83
DFPC-029-4	11" x 8½"	Yes	No	4	32#	220.98	294.73	506.48	932.64	2,261.70

(R)

*Also available as DFCSF-829-4 item number.

Snap-A-Part - 2 Part

Cat. No.	DFCC- Size	Pts.	Wt. per 1000	Carbonless Lot Prices				
				250	500	1000	2000	3000
830-2	4¼" x 7"	2	6#	79.92	99.81	146.01	238.22	326.55
831-2	5½" x 8½"	2	9#	86.55	112.86	171.62	289.32	404.89
832-2	8½" x 7"	2	10#	92.57	122.66	190.08	323.60	464.15
834-2	8½" x 11"	2	16#	118.58	155.60	208.54	407.54	598.08
835-2*	8½" x 11"	2	25#	115.52	159.17	260.05	493.94	730.58

*Last part is manila tag. (R)
No back printing available.

Snap-A-Part - 3 Part

Cat. No.	DFCC- Size	Pts.	Wt. per 1000	Carbonless Lot Prices				
				250	500	1000	2000	3000
830-3	4¼" x 7"	3	9#	87.47	115.31	176.21	298.61	422.43
831-3	5½" x 8½"	3	13#	97.87	135.10	216.50	374.70	539.33
832-3	8½" x 7"	3	16#	110.72	156.93	255.56	451.71	648.16
833-3	8½" x 8½"	3	20#	124.39	175.19	284.12	500.16	718.74
834-3	8½" x 11"	3	25#	136.53	199.56	331.35	595.12	863.07
835-3*	8½" x 11"	3	35#	137.65	206.91	346.75	641.53	937.64
836-3*	5½" x 8½"	3	21#	98.79	137.75	221.70	384.69	554.42
837-3*	8½" x 8½"	3	26#	130.31	189.57	314.72	562.68	812.28

*Last part is manila tag. (R)
No back printing available.

Snap-A-Part - 4 Part

Cat. No.	DFCC- Size	Pts.	Wt. per 1000	Carbonless Lot Prices				
				250	500	1000	2000	3000
831-4	5½" x 8½"	4	20#	103.58	143.36	228.84	398.77	576.56
832-4	8½" x 7"	4	25#	127.35	188.96	316.15	559.22	826.56
833-4	8½" x 8½"	4	26#	144.99	213.74	357.46	638.27	922.85
834-4	8½" x 11"	4	32#	150.20	230.27	395.61	729.66	1,062.08
835-4*	8½" x 11"	4	43#	167.84	253.32	431.72	790.86	1,149.08
836-4*	5½" x 8½"	4	27#	109.91	159.38	264.74	471.09	684.78

*Last part is manila tag. (R)
No back printing available.

Special Feature Prices

Cat.No.	Quantity Lot Prices				
	250	500	1000	2000	3000
Numbering on Imprinted Forms/Books					
310025	13.17	13.17	18.16	35.74	52.88
2-Hole Punch					
310050	23.94	23.94	23.94	28.37	32.67
3-Hole Punch					
310056	37.78	37.78	37.78	42.32	46.97
Heavy/Full Custom Composition					
310020	156.58 all quantities				
Medium Composition Changes/Deletions					
310015	63.31 all quantities				
Light Composition					
310014	24.16 all quantities				
Snaps Bound in Books of 50					
330021	11.42 per 1000 all quantities				
Fax Proof					
310007	15.32 per proof				

(R)

NOTE:

Maximum Imprint Area

Form Size	Imprint Size
4¼" x 7"	3¾" x 6¼"
5½" x 8½"	5" x 7¾"
8½" x 7"	8" x 6¼"
8½" x 8½"	8" x 7¾"
8½" x 11"	8" x 10¼"



Includes your company's name, address and phone number in one of four colors! For blank forms, subtract 30%.



Colors correspond to sequence and number of parts selected in your order unless otherwise specified.



! Envelopes available, see page 100.

Full Body Crash Printed!

Choose from one of four standard ink colors, red, green, blue or black, for your imprint. These forms are full body crash imprinted so fine lines, screens and heavy solids do not reproduce well.

Place Your Copy and Design Here

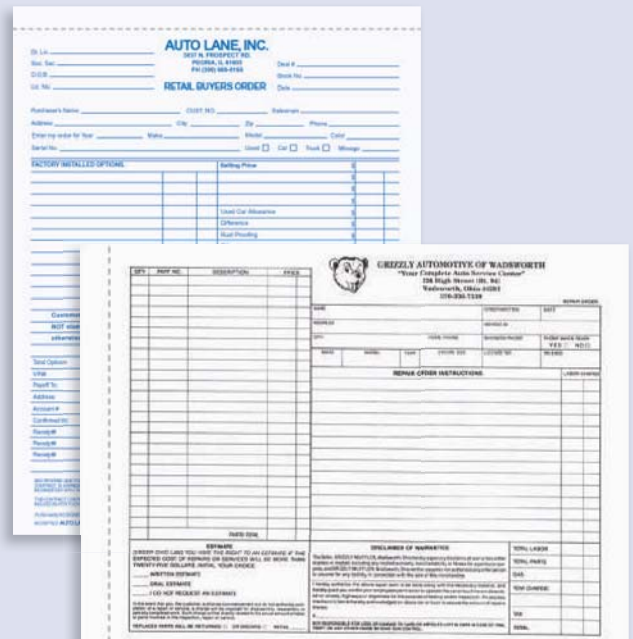

Stock Logos

										
Appliance AP-1	Appliance AP-2	Appliance AP-3	Appliance AP-4	Appliance AP-5	Appliance AP-6	Appliance AP-7	Appliance AP-8	Appliance AP-10	Auto Repair AU-1	Auto Sales AU-2
										
Auto Sales AU-3	Auto Sales AU-5	Auto Repair AU-6	Auto Repair AU-7	Auto Repair AU-8	Auto Repair AU-9	Auto Repair AU-10	Auto Repair AU-13	Auto Repair AU-16	Auto Repair AU-19	Auto Repair AU-20
										
Auto Repair AU-21	Auto Repair AU-22	Auto Repair AU-23	Beauty BE-1	Beauty BE-2	Beauty BE-3	Beauty BE-4	Beauty BE-5	Beauty BE-6	Building BU-2	Building BU-3
										
Building BU-5	Building BU-6	Building BU-7	Building BU-8	Building BU-11	Building BU-12	Building BU-13	Building BU-14	Building BU-15	Building BU-16	Building BU-17
										
Carpet CA-1	Carpet CA-2	Carpet CA-3	Carpet CA-4	Carpet CA-5	Cleaning CL-2	Cleaning CL-3	Cleaning CL-4	Cleaning CL-5	Cleaning CL-6	Cleaning CL-7
										
Cleaning CL-9	Cleaning CL-10	Cleaning CL-11	Cleaning CL-12	Cleaning CL-13	Clothing CS-1	Clothing CS-2	Clothing CS-3	Clothing CS-4	Clothing CS-5	Clothing CS-6
										
Construction CO-1	Construction CO-3	Construction CO-4	Construction CO-6	Construction CO-7	Construction CO-8	Construction CO-10	Drugs DR-1	Drugs DR-2	Drugs DR-3	Drugs DR-4
										
Drugs DR-6	Electrical EL-1	Electrical EL-2	Electrical EL-4	Electrical EL-5	Electrical EL-6	Exterminator EX-1	Exterminator EX-4	Exterminator EX-5	Exterminator EX-6	Exterminator EX-7
										
Exterminator EX-9	Farming FA-1	Farming FA-2	Farming FA-3	Farming FA-4	Farming FA-5	Farming FA-7	Farming FA-8	Farming FA-9	Farming FA-10	Farming FA-11



Flooring
FL-1



Flooring
FL-5



Flooring
FL-6



Flooring
FL-7



Flooring
FL-8



Flooring
FL-9



Food
FO-1



Food
FO-2



Food
FO-3



Food
FO-4



Food
FO-5



Food
FO-6



Food
FO-7



Food
FO-8



Food
FO-9



Food
FO-10



Food
FO-11



Food
FO-12



Food
FO-13



Food
FO-14



Food
FO-15



Food
FO-16



Food
FO-17



Food
FO-18



Food
FO-20



Food
FO-21



Food
FO-22



Food
FO-23



Floral/Gift
GI-1



Floral/Gift
GI-2



Floral/Gift
GI-4



Floral/Gift
GI-5



Floral/Gift
GI-6



Floral/Gift
GI-7



Floral/Gift
GI-8



Floral/Gift
GI-12



Floral/Gift
GI-13



Floral/Gift
GI-14



Floral/Gift
GI-15



Floral/Gift
GI-16



Floral/Gift
GI-17



Floral/Gift
GI-18



Floral/Gift
GI-21



Floral/Gift
GI-22



Floral/Gift
GI-23



Floral/Gift
GI-24



Floral/Gift
GI-25



Floral/Gift
GI-26



Floral/Gift
GI-27



Floral/Gift
GI-28



Floral/Gift
GI-29



Furniture
FU-3



Furniture
FU-4



Furniture
FU-5



Furniture
FU-6



Heat/Air
HE-3



Heat/Air
HE-4



Heat/Air
HE-5



Heat/Air
HE-6



Heat/Air
HE-7



Heat/Air
HE-8



Heat/Air
HE-9



Heat/Air
HE-10



Heat/Air
HE-11



Home Repair
HO-3



Home Repair
HO-4



Home Repair
HO-6



Home Repair
HO-7



Home Repair
HO-12



Home Repair
HO-13



Home Repair
HO-14



Home Repair
HO-15



Home Repair
HO-18



Hotel/Motel
HM-1



Hotel/Motel
HM-2



Hotel/Motel
HM-3



Hotel/Motel
HM-4



Insurance
IN-1



Insurance
IN-2



Insurance
IN-3



Insurance
IN-4



Insurance
IN-6



Jewelry
JE-2



Jewelry
JE-3



Jewelry
JE-5



Jewelry
JE-6



Jewelry
JE-7



Jewelry
JE-8



Jewelry
JE-9



Jewelry
JE-10



Jewelry
JE-12



Jewelry
JE-13



Landscaping
LA-1



Landscaping
LA-2



Landscaping
LA-4



Landscaping
LA-5



Landscaping
LA-6



Landscaping
LA-7



Landscaping
LA-8

Stock Logos



Landscaping
LA-9



Legal
LE-1



Legal
LE-2



Legal
LE-3



Legal
LE-4



Marinas
MA-1



Marinas
MA-2



Marinas
MA-3



Marinas
MA-4



Marinas
MA-6



Marinas
MA-7



Marinas
MA-8



Marinas
MA-9



Misc.
MI-1



Misc.
MI-2



Misc.
MI-3



Misc.
MI-4



Misc.
MI-5



Misc.
MI-6



Misc.
MI-7



Misc. Retail
MR-1



Misc. Retail
MR-2



Misc. Retail
MR-4



Misc. Retail
MR-5



Misc. Retail
MR-6



Misc. Retail
MR-7



Misc. Retail
MR-9



Misc. Retail
MR-10



Misc. Retail
MR-11



Misc. Retail
MR-12



Motorcycle
MO-1



Motorcycle
MO-2



Motorcycle
MO-3



Motorcycle
MO-5



Motorcycle
MO-6



Office Supp.
OF-1



Office Supp.
OF-4



Office Supp.
OF-6



Office Supp.
OF-7



Office Supp.
OF-8



Office Supp.
OF-10



Office Supp.
OF-11



Office Supp.
OF-12



Office Supp.
OF-13



Painters
PA-1



Painters
PA-2



Painters
PA-3



Painters
PA-4



Painters
PA-5



Painters
PA-7



Painters
PA-8



Painters
PA-9



Painters
PA-10



Painters
PA-11



Photography
PH-1



Photography
PH-2



Photography
PH-3



Photography
PH-4



Photography
PH-5



Photography
PH-6



Photography
PH-7



Plumbing
PL-1



Plumbing
PL-2



Plumbing
PL-3



Plumbing
PL-4



Plumbing
PL-6



Plumbing
PL-7



Real Estate
RE-3



Real Estate
RE-4



Towing
TO-2



Towing
TO-3



Towing
TO-8



Towing
TO-9



Travel
TV-1



Travel
TV-2



Travel
TV-4



Travel
TV-5



Travel
TV-7



Trucks
TR-1



Trucks
TR-2



Trucks
TR-3



Trucks
TR-6



Trucks
TR-8



Trucks
TR-9



Trucks
TR-11

Locate the Perfect Form!

Finding the form you need is easy. We have provided this alphabetical index to help you find what you are looking for.

*New items are listed in red!

Form	Page	Form	Page	Form	Page	Form	Page	Form	Page	Form	Page
	#	491220.....	106	ARO-372-4.....	7	CDCC-374-5.....	41	DCCC-392-2.....	87	DFC-148-2.....	89
202.....	33	491230.....	106	ARO-373-4.....	10	CM-235-2.....	80	DCCC-392-3.....	87	DFC-174-1.....	91
204.....	33	491240.....	106	ARO-637-3.....	9	CM-235-3.....	80	DCCC-393-3.....	87	DFC-174-2.....	91
312.....	33	491250.....	160	ARO-637-4.....	9	CM-579-3.....	80	DCCC-394-2.....	87	DFC-175-1.....	91
412.....	30	491260.....	106	ARO-647-3.....	6	CMCC-574-4.....	79	DCCC-394-3.....	87	DFC-175-2.....	91
422.....	31	491270.....	106	ARO-647-4.....	6	CMCC-575-4.....	79	DCCC-470-2.....	87	DFC-176-1.....	91
434.....	31	491275.....	116	ARO-655-2.....	8	CMCC-576-3.....	80	DCCC-470-3.....	87	DFC-176-2.....	91
700.....	30	491276.....	116	ARO-655-3.....	8	CO-696-3.....	43	DCCC-472-2.....	87	DFC-182-1.....	91
814.....	30	491277.....	116	ARO-656-3.....	6	COCC-583-3.....	43	DCCC-472-3.....	87	DFC-182-2.....	91
0108.....	113	493000.....	105	ARO-657-3.....	8	COPA-185-2.....	37	DCCC-473-2.....	87	DFC-183-1.....	91
1209.....	108	493040.....	105	ARO-659-3.....	9	CPCC-795-3.....	23	DCCC-615-2.....	88	DFC-184-1.....	91
1226.....	108	493080.....	105	ARO-659-4.....	9	CPCC-796-3.....	23	DCCC-615-3.....	88	DFC-186-1..... 90	
4246.....	30	493160.....	105	ARO-666-3.....	7	CRB-110-2.....	66	DCCC-622-2.....	88	DFC-186-2..... 90	
4611.....	32	493200.....	105	ARO-671-4.....	10	CRB-110-3.....	66	DCCC-622-3.....	88	DFC-187-1..... 90	
4622.....	32	493240.....	105	ARO-672-4.....	7	CRB-111-2.....	66	DCCC-623-2.....	88	DFC-187-2..... 90	
4651.....	29	493400.....	105	ARO-682-3.....	9	CRB-111-3.....	66	DCCC-623-3.....	88	DFCC-830-2.....	133
4805.....	34	493440.....	105	ARO-682-4.....	9	CRB-114-2.....	66	DCCC-626-2.....	88	DFCC-830-3.....	133
4851.....	29	493480.....	105	AROCC-365-4.....	7	CRB-114-3.....	66	DCCC-626-3.....	88	DFCC-831-2.....	133
4901.....	32	493640.....	105	AROCC-374-4.....	10	CRB-117-2.....	66	DCCC-628-3.....	88	DFCC-831-3.....	133
4902.....	32	494000.....	105	AROCC-377-4.....	10	CRB-117-3.....	66	DCG-613-3.....	88	DFCC-831-4.....	133
4905.....	32	494040.....	105	AROCC-600-3.....	7	CRB-118-2.....	66	DCM-578-3.....	80	DFCC-832-2.....	133
4912.....	31	494080.....	105	AROCC-624-3.....	9	CRB-118-3.....	66	DCR-9930.....	95	DFCC-832-3.....	133
4913.....	31	494160.....	105	AROCC-644-3.....	9	CRB-119-2.....	66	DDL-143-2.....	73	DFCC-832-4.....	133
4918.....	31	494200.....	105	AROCC-644-4.....	9	CRB-119-3.....	66	DDL-343-2.....	73	DFCC-833-3.....	133
4928.....	29	494240.....	105	AROCC-645-3.....	8	CRB-120-2.....	66	DFC-045-1.....	90	DFCC-833-4.....	133
4929.....	29	494400.....	105	AROCC-646-3.....	6	CRB-120-3.....	66	DFC-045-2.....	90	DFCC-834-2.....	133
9927.....	15	494440.....	105	AROCC-646-4.....	6	CS.....	119	DFC-046-1..... 90		DFCC-834-3.....	133
320009.....	122	494480.....	105	AROCC-648-4.....	10	CSCG.....	119	DFC-046-2..... 90		DFCC-834-4.....	133
320010.....	122	494640.....	105	AROCC-664-3.....	6	CSU-5132.....	108	DFC-054-1..... 90		DFCC-835-2.....	133
320011.....	122	495000.....	105	AROCC-665-4.....	7	CSU-5133.....	108	DFC-054-2..... 90		DFCC-835-3.....	133
320012.....	122	495040.....	105	AROCC-667-3.....	8	CSU-5134.....	108	DFC-104-1.....	90	DFCC-835-4.....	133
320013.....	122	495080.....	105	AROCC-677-4.....	10	CSU-5135.....	108	DFC-104-2.....	90	DFCC-836-3.....	133
320014.....	122	495160.....	105	AROCC-685-3.....	9	CSU-5136.....	108	DFC-121-1.....	89	DFCC-836-4.....	133
320015.....	122	495200.....	105	AROCC-685-4.....	9	CSU-5137.....	108	DFC-121-2.....	89	DFCC-837-3.....	133
320016.....	122	495240.....	105	B		CSU-5138.....	108	DFC-122-1.....	89	DFCC-840-2.....	86
320017.....	122	495400.....	105	BBL-321-5.....	71	CSU-5139.....	108	DFC-122-2.....	89	DFCC-840-3.....	86
320018.....	122	495440.....	105	BBL-621-5.....	71	CSU-8132.....	108	DFC-123-1.....	89	DFCC-841-2.....	86
320019.....	122	495480.....	105	BBLCC-620-5.....	71	CSU-8133.....	108	DFC-123-2.....	89	DFCC-841-3.....	86
320020.....	122	495640.....	105	BGS-555-2.....	18	CSU-8134.....	108	DFC-125-1.....	89	DFCC-842-2.....	86
323000.....	104	495650.....	103	BGS-565-2.....	18	CSU-8135.....	108	DFC-125-2.....	89	DFCC-842-3.....	86
324000.....	104	495660.....	103	BGS-575-2.....	18	CSU-8136.....	108	DFC-126-1.....	89	DFCC-843-2.....	86
325100.....	104	495670.....	103	BGS-675-2.....	18	CSU-8137.....	108	DFC-127-1.....	89	DFCC-843-3.....	86
333000.....	104	495680.....	103	BGS-685-2.....	18	CSU-8138.....	108	DFC-134-2.....	91	DFCSB-827-2.....	123
334000.....	104	495690.....	103	BGS-775-3.....	18	CSU-8139.....	108	DFC-135-2.....	91	DFCSB-827-3.....	123
336100.....	104	A		BGS-885-3.....	18	CSWBCCG.....	119	DFC-136-2.....	91	DFCSB-828-2.....	123
353391.....	112	AA-138-3..... 16		BL-601-3.....	71	CSWBGB.....	119	DFC-137-2.....	91	DFCSB-828-3.....	123
353392.....	112	AA-138-4..... 16		BL-601-4.....	71	CT-300.....	17	DFC-138-1.....	91	DFCSF-823-2.....	132
353393.....	112	AC-370-1.....	41	BLCC-602-3.....	71	CWCC-799-3.....	23	DFC-139-1.....	91	DFCSF-823-3.....	132
353394.....	112	AP-217-2.....	62	BLCC-602-4.....	71	CWICC-797-3.....	23	DFC-142-1.....	91	DFCSF-829-1.....	132
353397.....	112	AP-217-3.....	62	BLCC-604-3.....	71	D		DFC-143-1.....	91	DFCSF-889-2.....	132
393391.....	112	AP-232-2.....	62	BLCC-604-4.....	71	DC-243-2.....	61	DFC-144-1.....	89	DFCSF-889-3.....	132
393392.....	112	APR-667-4.....	45	BLG.....	118	DC-243-3.....	61	DFC-144-2.....	89	DFCSF-889-4.....	132
393393.....	112	APRCC-567-4.....	45	BPR-0024..... 83		DC-4601.....	117	DFC-145-1.....	89	DFCWB-027-2.....	126
393394.....	112	ARO-282-2.....	64	BPS.....	120	DC-610-3.....	88	DFC-145-2.....	89	DFCWB-027-3.....	126
393397.....	112	ARO-282-3.....	64	BR-598-1.....	33	DCB-612-3.....	88	DFC-147-1.....	89	DFCWB-028-2.....	126
491200.....	106	ARO-356-3.....	6	BR-598-2.....	33	DCCC-390-2.....	87	DFC-147-2.....	89	DFCWB-028-3.....	126
491210.....	106	ARO-371-4.....	10	C		DCCC-390-3.....	87	DFC-148-1.....	89	DFCWB-055-2.....	125

Form	Page	Form	Page	Form	Page	Form	Page	Form	Page	Form	Page
DFCWB-055-3	125	DFPC-089-4	132	ENV-9856	92	FM-9932	19	GRG	118	GSA-244-3	63
DFCWB-057-2	125	DFPC-099-2	132	ENV-9857	92	FM-9933	19	GRO-663-3	45	GSCC-552-3	50
DFCWB-057-3	125	DFPC-099-3	132	ENV-9868	26	FM-9934	19	GROCC-563-3	45	GSCC-652-2	50
DFCWB-060-2	126	DFPC-099-4	132	ENV-9869	26	FM-9935	19	GS-201-2	59	GSCC-652-3	50
DFCWB-060-3	126	DH-3091	107	ENV-9901	100	FM-9936	19	GS-201-3	59	GSCC-652-4	50
DFCWB-062-2	126	DH-3099	107	ENV-9905	100	FM-9941	19	GS-201-4	59	GSCC-653-2	50
DFCWB-062-3	126	DM-577-3	80	ENV-9906	100	FM-9942	19	GS-202-2	55	GSCC-653-3	50
DFCWB-066-2	126	DRCC-642-2	72	ENV-9907	100	FM-9944	19	GS-202-3	55	GSCC-670-2	51
DFCWB-066-3	126	DRCC-642-3	72	ENV-9908	100	FM-9945	19	GS-202-4	55	GSCC-670-3	51
DFCWB-068-2	126	DT-400-2	93	ENV-9909	100	FM-9946	19	GS-203-2	58	GSCC-670-4	51
DFCWB-068-3	126	DT-400-3	93	ENV-9910	100	FMT-897-3	15	GS-203-3	58	GSD-204-2	56
DFCWB-070-2	127	DT-410-2	93	ENV-9911	100	FMTCC-898-3	15	GS-203-4	58	GSD-204-3	56
DFCWB-070-3	127	DT-410-3	93	ENV-9912	100	FPCC-766-3	44	GS-209-2	57	GSDCC-643-2	50
DFCWB-072-2	127	DT-411-2	93	ENV-9913	100	FR-248-2	61	GS-209-3	57	GSF-214-2	26
DFCWB-072-3	127	DT-411-3	93	ENV-9914	100	FR-248-3	61	GS-215-2	59	GSF-214-3	26
DFCWB-083-2	127	DT-412-2	93	ENV-9915	101			GS-215-3	59	GSF-221-2	26
DFCWB-083-3	127	DT-412-3	93	ENV-9916	101	G		GS-222-3	56	GSF-221-3	26
DFCWB-088-2	127	DT-413-1	94	ENV-9917	101	GC-779-2	114	GS-223-2	57	GSF-229-2	26
DFCWB-088-3	127	DT-414-1	94	ENV-9918	101	GC-780-2	115	GS-223-3	57	GSF-229-3	26
DFCWB-090-2	128	DT-415-1	94	ENV-9919	101	GC-781-2	115	GS-224-2	56	GSF-239-2	26
DFCWB-090-3	128	DT-416-1	94	ENV-9937	101	GC-782-2	115	GS-224-3	56	GSFCC-639-3	26
DFCWB-092-2	128	DT-417-1	92	ENV-9938	101	GC-783-2	115	GS-226-2	55	GSFCC-649-3	26
DFCWB-092-3	128	DT-417-2	92	ENV-9939	101	GC-784-3	114	GS-226-3	55	GSR-225-2	62
DFCWB-095-2	128	DT-417-3	92	ENV-9940	96	GC-785-2	115	GS-227-2	60	GSR-225-3	62
DFCWB-095-3	128	DTJ-430-3	40	ENV-9955	96	GC-786-2	115	GS-227-3	60	H	
DFCWB-097-2	128	DTJ-431-3	40	ENV-9956	96	GC-787-2	115	GS-228-2	59	HAC-680-3	21
DFCWB-097-3	128	E		ENV-9957	96	GC-788-2	115	GS-228-3	59	HAC-681-3	21
DFCWB-824-2	127	ECO-674-3	14	ENV-9958	96	GC-790-2	115	GS-230-2	60	HAC-684-3	21
DFCWB-824-3	127	ECO-674-4	14	ENV-9959	96	GC-791-2	115	GS-230-3	60	HR-370-2	40
DFCWB-824-4	127	ELCC-798-3	47	ENV-9960	39	GC-792-2	115	GS-234-2	58	HRCC-365-2	41
DFCWB-826-2	126	ENV-4420	95	ENV-9961	38	GC-793-2	115	GS-234-3	58	HVAC-683-3	21
DFCWB-826-3	126	ENV-4421	95	ENV-9962	100	GCD-784-5	114	GS-237-2	58	I	
DFCWB-826-4	126	ENV-9804	99	ENV-9963	100	GJ-212-2	27	GS-237-3	58	INV-751-3	74
DFCWB-884-2	127	ENV-9805	99	ENV-9964	100	GJ-212-3	27	GS-240-2	60	INV-751-4	74
DFCWB-884-3	127	ENV-9806	99	ENV-9968	39	GJ-219-2	27	GS-240-3	60	INV-751-5	74
DFCWB-886-2	126	ENV-9807	99	ENV-9969	39	GJ-219-3	27	GS-251-2	59	INV-752-3	74
DFCWB-886-3	126	ENV-9809	99	ERO-660-2	11	GJ-241-2	27	GS-251-3	59	INV-752-4	74
DFMB-020-2	123	ENV-9810	99	ERO-660-3	11	GJ-241-3	27	GS-252-2	59	INV-754-2	75
DFMB-020-3	123	ENV-9814	99	EROCC-560-2	11	GP-139-2	52	GS-252-3	59	INV-754-3	75
DFMB-034-2	123	ENV-9815	99	EROCC-560-3	11	GP-139-3	52	GS-253-2	59	INV-754-4	75
DFMB-034-3	123	ENV-9816	99	ES-697-2	11	GP-149-2	51	GS-253-3	59	INV-764-3	75
DFMB-036-2	123	ENV-9818	99	F		GP-149-3	51	GS-254-2	55	INV-764-4	75
DFMB-036-3	123	ENV-9823	99	FCSU-5391	108	GP-151-2	51	GS-254-3	55	INV-764-5	75
DFMB-037-2	123	ENV-9824	99	FCSU-5392	108	GP-151-3	51	GS-255-2	55	INV-781-4	76
DFMB-037-3	123	ENV-9825	99	FCSU-5393	108	GP-152-2	53	GS-255-3	55	INV-781-5	76
DFMB-063-2	123	ENV-9826	99	FCSU-5394	108	GP-153-2	52	GS-256-2	55	INVCC-750-2	74
DFMB-063-3	123	ENV-9827	99	FCSU-5395	108	GP-153-3	52	GS-256-3	55	INVCC-750-3	74
DFPC-023-2	132	ENV-9828	99	FCSU-8391	108	GP-154-2	51	GS-271-2	58	INVCC-750-4	74
DFPC-023-3	132	ENV-9829	99	FCSU-8392	108	GP-154-3	51	GS-271-3	58	INVCC-753-3	74
DFPC-023-4	132	ENV-9830	99	FCSU-8393	108	GP-155-2	53	GS-272-2	58	INVCC-753-4	74
DFPC-029-2	132	ENV-9831	98	FCSU-8394	108	GP-155-3	53	GS-272-3	58	INVCC-755-2	75
DFPC-029-3	132	ENV-9832	98	FCSU-8395	108	GP-156-2	54	GS-273-2	58	INVCC-755-3	75
DFPC-029-4	132	ENV-9833	98	FGC-625-1	26	GP-156-3	54	GS-273-3	58	INVCC-755-4	75
DFPC-069-2	132	ENV-9834	98	FH-9977	43	GP-157-2	54	GS-651-2	50	INVCC-757-3	76
DFPC-069-3	132	ENV-9835	98	FH-9979	43	GP-157-3	54	GS-651-3	50	INVCC-758-3	76
DFPC-069-4	132	ENV-9837	98	FH-9980	43	GP-158-2	51	GS-651-4	50	INVCC-758-4	76
DFPC-079-2	132	ENV-9838	98	FM-9921	19	GP-158-3	51	GS-654-2	50	INVCC-759-3	76
DFPC-079-3	132	ENV-9839	98	FM-9922	19	GP-159-2	52	GS-654-3	50	INVCC-760-2	75
DFPC-079-4	132	ENV-9840	98	FM-9923	19	GP-159-3	52	GSA-210-2	57	INVCC-760-3	75
DFPC-089-2	132	ENV-9854	92	FM-9924	19	GR	118	GSA-210-3	57	INVCC-760-4	75
DFPC-089-3	132	ENV-9855	92	FM-9931	19	GRCC-694-2	34	GSA-244-2	63	INVCC-765-2	75

Form	Page	Form	Page	Form	Page	Form	Page	Form	Page		
INVCC-765-3.....	75	M		P4A3A25.....	116	PTS-165-2.....	49, 109	SCCC-481-2.....	87	STR-317-2.....	109
INVCC-765-4.....	75	MAC-9968.....	65	P4A3A50.....	116	PTS-165-3.....	49, 109	SCCC-481-3.....	87	STR-317-3.....	109
INVCC-765-5.....	75	MAC-9969.....	65	PACC-692-3.....	42	PTS-165-4.....	49, 109	SCCC-482-2.....	87	STWCC-313-2.....	111
INVCC-767-3.....	75	MAC-9970.....	65	PACC-693-2.....	42	PTS-165-5.....	49, 109	SCCC-482-3.....	87	STWCC-323-2.....	111
INVCC-782-4.....	76	MAC-9972.....	65	PACC-693-3.....	42	PTW-165-1.....	49, 109	SCCC-483-3.....	87	STWCC-343-3.....	111
J		MAC-9973.....	65	PC-881-3.....	22	PTW-165-2.....	49, 109	SCCC-484-3.....	87	STYL.....	120
JI-216-3.....	61	MAC-9975.....	65	PCCC-880-3.....	22	PTW-165-3.....	49, 109	SCCC-616-2.....	88	STYLCL.....	120
JRE-9947.....	27	MB-012-2.....	52	PCCC-882-2.....	22	PTW-165-4.....	49, 109	SCCC-616-3.....	88	SU-1131.....	108
JRE-9948.....	27	MB-247-2.....	53	PCICC-879-2.....	22	PTW-165-5.....	49, 109	SCCC-617-2.....	88	SU-3131.....	108
JWO-860-3.....	48	MB-258-2.....	53	PDE-9949.....	37	Q		SCCC-617-3.....	88	SU-5131.....	108
JWO-861-3.....	46	MB-347-3.....	53	PF-8832.....	97	QFCC-691-3.....	42	SCCC-618-2.....	88	SU-8131.....	108
JWOCC-862-3.....	46	MB-358-3.....	53	PF-8833.....	97	R		SCCC-618-3.....	88	SWO-207-2.....	49
JWOCC-870-3.....	48	MC.....	120	PF-8834.....	97	RA-581-3.....	35	SCCC-619-2.....	88	SWO-207-3.....	49
K		MCF-387-1.....	38	PG.....	120	RACC-582-3.....	35	SCCC-619-3.....	88	SWO-643-4.....	13
KBPCC-867-3.....	44	MCF-387-2.....	38	PH-211-2.....	36	RB-9984.....	95	SCCC-627-2.....	88	SWOCC-640-4.....	13
KBWCC-871-3.....	44	MCF-389-1.....	38	PH-211-3.....	36	RB-9985.....	95	SCCC-627-3.....	88	T	
L		MCG.....	120	PH-233-2.....	36	RB-9987.....	95	SERO-635-3.....	20	TC-5031.....	40
LC-5770.....	92	MCH-350-1.....	17	PH-233-3.....	36	RE-661-3.....	11	SEROCC-638-3.....	20	TERCC-363-2.....	41
LC-5771.....	92	MCH-351-1.....	17	PLCC-853-2.....	36	RECC-621-3.....	11	SFCC-740-2.....	86	TI-3513.....	111
LC-5772.....	92	MCH-352-1.....	17	PLBCC-665-3.....	47	RECC-574-3.....	73	SFCC-740-3.....	86	TL-3509.....	110
LC-5776.....	92	MCH-353-1.....	17	PLBCC-955-3.....	47	RF-640-3.....	72	SFCC-741-2.....	86	TPR-0026.....	83
LC-5777.....	92	MCH-354-1.....	17	PLCC-630-2.....	71	RFCC-641-3.....	72	SFCC-741-3.....	86	TPR-0027.....	83
LC-5778.....	92	MGBC30.....	106	PLCC-630-3.....	71	RM-858-3.....	81	SFCC-742-2.....	86	TPR-0028.....	83
LE-791-1.....	25	MLCC-800-2.....	82	PLE-9430.....	71	RMCC-848-2.....	81	SFCC-742-3.....	86	TR-3510.....	110
LF-5701.....	102	MLCC-802-2.....	82	PM-101-2.....	82	RMCC-848-3.....	81	SFCC-745-3.....	86	TRO-638-4.....	14
LF-5702.....	102	MLCC-803-2.....	82	PMRCG.....	121	RMCC-868-3.....	81	SFCC-746-2.....	86	TROCC-633-4.....	14
LF-5703.....	102	MLCC-803-3.....	82	PMRMC.....	121	RO-673-3.....	7	SFCC-746-3.....	86	TS.....	121
LF-5704.....	102	MLR-113-2.....	42	PO-700-2.....	68	RO-658-3.....	8	SFCC-747-2.....	86	TSCL.....	121
LF-5705.....	102	MPACC-736-3.....	20	PO-700-3.....	68	ROCC-558-3.....	8	SFCC-747-3.....	86	TVR-669-4.....	45
LF-5706.....	102	MPVCC-690-2.....	14	PO-700-4.....	68	ROCC-573-3.....	7	SO-620-3.....	72	TVRCC-569-4.....	45
LF-5708.....	102	MPVCC-690-3.....	14	PO-701-3.....	68	ROI-694-4.....	12	SOCC-505-2.....	12	TWP.....	118
LF-5709.....	102	MPVCC-690-4.....	14	PO-703-3.....	68	RS.....	121	SOCC-505-3.....	12	V	
LF-5711.....	102	MRB-109-3.....	37	PO-703-4.....	68	RS-242-2.....	64	SOCC-505-4.....	12	VC-800-1.....	34
LF-5712.....	102	MRM-810-3.....	81	POB-311-3.....	67	RS-242-3.....	64	SOCC-629-3.....	72	VGEL.....	119
LF-5713.....	102	MRM-859-3.....	81	POB-312-3.....	67	RSB-142-2.....	17, 52	SOCC-695-3.....	12	VRA-200-2.....	35
LF-5714.....	102	MRO-636-3.....	20	POCC-702-3.....	68	RSB-142-3.....	17, 52	SOF-698-3.....	51	VRA-231-2.....	35
LF-5715.....	102	MROCC-634-3.....	20	POCC-702-4.....	68	RSD-141-2.....	16, 54	SOFC-699-3.....	51	VRACC-580-2.....	35
LF-5716.....	102	MRPG.....	118	POCC-704-2.....	68	RV-643-3.....	72	SP-208-2.....	63	VRACC-580-3.....	35
LF-5718.....	102	MS-249-2.....	20	POCC-704-3.....	68	S		SP-208-3.....	63	VT-245-2.....	36
LF-5719.....	102	MS-249-3.....	20	POCC-706-2.....	69	SA-1506-3.....	15	SP-238-2.....	63	VT-246-2.....	36
LMCC-793-3.....	25	N		POCC-706-3.....	69	SA-1506-4.....	15	SP-238-3.....	63	VTCC-845-2.....	36
LPCC-792-3.....	24	NC-124-2.....	16, 67	POCC-707-2.....	68	SC-607-3.....	88	SS-213-2.....	64	W	
LS-5730.....	78	NC-124-3.....	16, 67	POCC-707-3.....	68	SC-608-3.....	88	SS-213-3.....	64	WFCC-648-2.....	26
LS-5731.....	78	NC-146-2.....	16	POCC-707-4.....	68	SC-609-3.....	88	SS-236-2.....	64	WO-662-3.....	48
LS-5732.....	78	NC-146-3.....	16	POCC-707-5.....	68	SC-611-3.....	88	SS-236-3.....	64	WOCC-632-3.....	48
LS-5733.....	78	NP-2000.....	117	POCC-708-3.....	69	SC-614-3.....	88	ST-678-2.....	77	WOCC-850-3.....	28
LS-5734.....	78	NP-2100.....	117	POCC-717-3.....	69	SCB-115-2.....	49	ST-686-2.....	77	WOICC-890-3.....	46
LS-5735.....	78	NP-2200.....	117	PP-2600.....	39	SCCA-375-4.....	13	ST-688-2.....	77	WOICC-890-4.....	46
LS-5736.....	78	NP-2300.....	117	PP-2601.....	39	SCCACC-385-4.....	13	STB-301-2.....	110	WOICC-891-2.....	28
LS-5737.....	78	NP-2400.....	117	PP-2602.....	39	SCCC-380-2.....	87	STC-305-2.....	110	WOICC-891-3.....	28
LS-5738.....	78	NP-2500.....	117	PP-2603.....	39	SCCC-380-3.....	87	STCC-677-2.....	77		
LS-5739.....	78	NS-247-2.....	32	PR-0023.....	83	SCCC-381-2.....	87	STCC-679-2.....	77		
LS-5740.....	78	O		PSCC-865-3.....	28	SCCC-381-3.....	87	STCC-687-2.....	77		
LS-5741.....	78	OARE-9920.....	15	PSCC-895-3.....	46	SCCC-382-2.....	87	STCC-689-2.....	77		
LS-5742.....	78	OACC-668-3.....	17	PSECC-863-3.....	28	SCCC-382-3.....	87	STCC-689-3.....	77		
LS-5743.....	78	OACC-669-3.....	17	PT-165-1.....	49, 109	SCCC-383-2.....	87	STCC-689-4.....	77		
LS-5744.....	78	P		PT-165-2.....	49, 109	SCCC-383-3.....	87	STCC-689-5.....	77		
LT-584-2.....	43	P3A3A25.....	116	PT-165-3.....	49, 109	SCCC-384-2.....	87	STOICC-341-3.....	13		
LWO-893-1.....	25	P3A3A50.....	116	PT-165-4.....	49, 109	SCCC-384-3.....	87	STR-302-1.....	110		
LWOCC-245-3.....	28	P3A8A25.....	116	PT-165-5.....	49, 109	SCCC-480-2.....	87	STR-302-3.....	110		
LWOCC-794-3.....	24	P3A8A50.....	116	PTS-165-1.....	49, 109	SCCC-480-3.....	87	STR-307-1.....	109		

Index - By Product Name

Form	Page
A	
Appliance Repair Form.....	45
Application for Employment.....	40
Attendance Calendar.....	41
Automotive Forms:	
Buyer's Guide.....	18
Cash Receipt Book.....	16
Daily Time/Job Ticket.....	40
Document Jackets.....	96
Emission Control Work Order.....	14
Estimate.....	10-11
Floor Mats - Car.....	19
Floor Mats - Truck.....	19
Fuel Meter Ticket.....	15
Heating & Air.....	21
Multi-Point Vehicle Inspection.....	14
Odometer Disclosure.....	17
Overnight Auto Repair Envelope.....	15
Purchase Order Book.....	16
Repair Order.....	6-11
Road Service Book.....	16-17, 54
Smog Control Order.....	13
Special Order Form.....	12
Transmission Repair.....	14
We Owe.....	15
Weekly Service Appt. Pad.....	15
B	
Bi-Lingual Forms:	
Buyer's Guide.....	18
General Sales.....	50,56
Guest Checks/Restaurant.....	29
Invoice.....	75
Purchase Order.....	69
Register Form.....	56
Bills of Lading.....	70-71
Business Cards.....	104-106
Buyers Guides.....	18
C	
Calendars.....	116
Cards:	
Business Cards.....	104-106
Punch Cards.....	117
Magnetic Business Cards.....	106
Cash Receipt Books.....	16, 66
Change Order.....	43
Checks:	
Accounts Payable.....	87-88
Check Binder.....	95
Design-A-Form™.....	86
Dual Purpose.....	87-88
General Expense - 3-on-a-page.....	89-91
Laser Checks.....	92
Payroll - 3-on-a-page.....	89-91
Select-A-Style.....	84-85
Cleaning Forms.....	23

Form	Page
Collection Forms.....	79
Credit Memos.....	80
Custom Forms:	
Books.....	123-129
Book Covers.....	124
Design-A-Form™.....	133
Manifold Books.....	123
One-Part.....	132
Ready-To-Go.....	125-131
Snap-A-Part.....	132
Twin Loop Wire Bound Bks.....	125-129
D	
Daily Cash Report Envelope.....	95
Daily Time/Job Ticket.....	40
Debit Memo.....	80
Delivery Receipts.....	72
Deposit Tickets.....	92-94
Design-A-Form™.....	86, 133
Document Jackets.....	96
Door Hangers:	
Custom/Imprinted.....	107
Preprinted.....	107
Driver's Log Book.....	73
DVD Rental.....	35
E	
Electrical Forms.....	47
Envelopes:	
Automotive Invoice.....	100
Business Reply.....	99
Catalog/Booklet.....	98
Checks.....	92, 100
Daily Cash Report.....	95
General.....	99-101
Jewelry Repair.....	27
Kraft First Class.....	98
Overnight Auto Repair.....	15
Medical Claim.....	38-39
Packing List.....	71
Pill/Drug Envelope.....	37
Recycled.....	100
Self Sealing.....	101
Stationery.....	103-105
Teller Helper Envelopes.....	95
Tyvek Catalog.....	98
Tyvek First Class.....	98
Estimates:	
Auto.....	10-11
Kitchen/Bath.....	44
Landscaping.....	25
Protection.....	28
Repair.....	10-11, 45
F	
Floor Mats.....	19
Florist Gift Cards and Envelopes.....	26
Florist Sales Forms.....	26

Form	Page
Form Holders.....	24, 43
Framing Form.....	61
Freight Bill.....	71
Fuel Meter Ticket.....	15
G	
General Repair Forms.....	45
Gift Certificates.....	114-115
Gift Certificate Display.....	114-115
Glass Work Order.....	46
Guest Checks.....	29-33
Guest Checks - Bar.....	29
Guest Checks - Bi-lingual.....	29
H-I	
Health Forms.....	37-39
Hotel Registration.....	34
Human Resource Forms.....	40-41
HVAC Forms.....	21
Inventory Tags.....	111
Invoices:	
Bi-Lingual.....	75
Janitorial.....	23
Job.....	61
Lawn Maintenance.....	24-25
Locksmith.....	28
Pest Control.....	22
Protection.....	28
Snap-A-Parts.....	74-76
J-L	
Janitorial Forms.....	23
Jewelry Repair Register.....	27
Job Work Orders.....	See Work Order
Key Card Holders.....	34
Kitchen/Bath Remodeling Forms.....	44
Labels, Laser.....	112
Labels, Mailing.....	113
Landscaping Forms.....	24-25
Laser/Inkjet Cut Sheets.....	78, 102
Layaway Tags.....	110
Letterhead.....	103-105
Letter of Transmittal.....	43
Locksmith Form.....	28
M	
Magnetic Business Card.....	106
Manifold Books.....	123
Marine Forms.....	20
Material/Labor Record.....	42
Medical Forms.....	37-39
Memos:	
Collection.....	79
Credit.....	80
Debit, Debit/Credit.....	80
Phone.....	82
Memo Letters.....	82
Message/Reply.....	81
Motorcycle Repair.....	20
Multiform Books.....	124-129

Index - By Product Name

Form	Page
N-O	
Note Pads.....	116-117
Odometer Disclosure.....	17
Office Supplies:	
Phone Memo Book.....	82
Pressure Sensitive Labels.....	112-113
Self Inking Stamps.....	122
Thermal Rolls.....	83
Writing Instruments.....	118-121
P	
Packing List:	
Envelopes.....	71
Packing List Form.....	71
Pens and Pencils.....	118-121
Pest Control Forms.....	22
Pharmacy Forms.....	36
Phone Memos.....	82
Plumbing Work Order.....	47
Pool Services.....	46
Prescription Pads.....	39
Presentation Folders.....	97
Pressure Sensitive Shipping Labels.....	112-113
Promotional Advertising.....	106, 116, 118-121
Proposals.....	23-24, 42
Proposal/Acceptance.....	42
Protection/Security Forms.....	28
Punch Cards.....	117
Purchase Orders:	
Bi-Lingual.....	69
Snap-A-Part.....	68-69
Twin Loop Wire Bound Bks 3 and 4-on-a-page.....	16, 67
Q	
Quotation Form.....	42
R	
Ready-To-Go Forms.....	125-131
Receiving Forms.....	72
Register Forms:	
Apparel.....	62
Auto Service.....	63
Bi-Lingual.....	56
Credit Memo.....	80
Dry Cleaners.....	61
Florist Sales.....	26
Framing/Matting.....	61
General Sales.....	55-60
Gift/Jewelry.....	27
Job Invoice.....	61
Locksmith.....	28
Marine.....	20
Pharmacy.....	36
Retail Sales.....	62
Road Service.....	64
Service Station.....	64
Service Work Order.....	49

Form	Page
Stock Parts.....	63
Veterinary.....	36
Video/DVD Rental.....	35
Register Machines.....	65
Remodeling.....	44
Rental Agreement.....	35
Repair Orders:	
Appliance Repair.....	45
Auto.....	6-11
General Repair.....	45
Marine Repair.....	20
Motorcycle/Small Engine.....	20
Repair Estimate Order.....	45
Service Order.....	12
Transmission.....	14
Repair Tags.....	109-110
Requisition.....	73
Restaurant Forms:	
Gift Certificates.....	114-115
Guest Checks.....	29-33
Punch Cards.....	117
Return To Vendor.....	72
Road Service Book.....	16-17, 52
S	
Sales Books:	
General.....	51-53
Road Service.....	16, 52, 54
Service Station.....	53
Twin Loop Wire Bound.....	54
Sales Forms:	
Bi-Lingual.....	50, 56
Florist.....	26
General.....	50-51
Retail/DVD/Video Rental.....	35
Sales Order.....	51
Security Protection Forms.....	28
Service Call Book.....	49
Service Order.....	12
Service Work Order.....	49
Shipping Order.....	72
Small Engine Repair.....	20
Smog Forms.....	13
Special Order.....	12
Stamps, Self-Inking.....	122
Statements.....	77-78
Statements, Laser.....	78
Stationery.....	103-105
Sticky Notes.....	116
String (for Tags).....	108
T	
Tags:	
Blank.....	108
Inventory.....	111
Layaway.....	110
Repair.....	109-110

Form	Page
Valet Parking.....	34
Work Order.....	49, 109
Teller Helper Envelopes.....	95
Thermal Rolls.....	83
Time Cards.....	40
Transmission Repair.....	14
V	
Valet Parking Tag.....	34
Veterinary Forms.....	36
Video/DVD Rental.....	35
W	
Wedding Flower Order Form.....	26
Weekly Service Appt. Pad.....	15
Wire (for Tags).....	108
Work Orders:	
Cleaning.....	23
Electrical.....	47
Emissions Control.....	14
General.....	46, 48-49
Glass.....	46
Kitchen/Bath.....	44
Landscaping.....	24-25
Locksmith.....	28
Plumbing.....	47
Pool Services.....	46
Protection.....	28
Service.....	49
Smog Check.....	13
Work Order/Invoice.....	46
Work Order Tags.....	49, 109

Ordering Information

Logos

We will print one of the Stock Logos shown on pages 134 - 136 in this catalog at no additional charge. Logos can be positioned to the left, right, above or below your imprint, dependent on your total imprint size.

The Stock Logos shown in this catalog are only a sample of the hundreds available.

When requesting a stock logo, please specify by ID code.

Special Features

Options listed below meet most special needs for an additional charge. If you need a feature we haven't anticipated, call us!

Booking – \$11.42/M(R)

Carbonless Snap-A-Part Forms can be booked into sets of 50 (stapled through the stub and wrapped with a heavy manila backer).

Padding – \$4.18/M(R)

Guest Checks on page 29 - 33 can be padded into sets (hot-glued together with a hard backer for writing support and security).

Packing (with drilled hole) – \$16.56(R) per 500 sets

Most forms can be shrink-wrapped in sets of 50 with a drilled hole at the top. Just order the item number followed by PK.

Packing (without drilled hole) – See Pricing Below

Most forms can be shrink-wrapped in sets of 50 and 100 without a drilled hole (includes firm chipboard for sturdy packaging).

PKGs in 50's

250–\$11.58 500–\$16.00 1,000–\$23.49(R)

PKG IN 100'S

500–\$13.28 1,000–\$18.84 5,000–\$65.58(R)

Extra Imprint Lines – \$18.04(R)

Add additional lines of type (up to six lines) in the body of most imprinted forms.

Proof – \$15.35(R)

We can fax or email a proof to you for any imprinted order.

Digital Press Proof – \$127.50(R)

Starting Numbers (4, 5 and 7 digits) – \$14.41/M(R)

Register Forms must have a seven-digit starting number. All other imprinted forms have a six-digit number at no extra charge. Four, five and seven-digit numbering is available at an additional charge.

Forms Fulfillment – Call for Details

We will print your special forms in large quantities and warehouse them for you. Upon request, we'll send them with the appropriate branch or location information in quantities as low as 250. It's a convenient money-saver for companies with multiple offices, branches, locations or franchises.

Rush Orders – Call for Details

For orders that can't wait.

Acceptable Programs (PC Based)

QuarkXPress®: Version 7.0 or less.

(Hint: Quark has a command "Collect for Output" that will automatically gather everything needed to successfully output your document.)

Adobe Acrobat Pro®: PDF Files

Adobe Indesign®

Adobe Illustrator®. Save as an EPS file. Create outlines on all fonts.

Adobe PageMaker®. Save as a PageMaker file.

Macromedia® Freehand: version 8.0 or less. Save as an EPS file.

CorelDraw™: Version 12.0 or less. Save as a normal CDR file.

Microsoft® Word 2000: Save as a DOC file. (NOT recommended for forms design)

Microsoft® Excel 2000: Save as a XLS file. (NOT recommended for forms design)

Microsoft® Publisher 2000: Save as a PUBLISHER file.

Photoshop

File Information:

PDF files ARE accepted but files cannot be altered if changes are to be made.

All EPS and TIFF files used in creating the document must be included.

Art must be made to the correct size of the printed piece. Save a copy of each piece to be printed under a different file name. Include a copy of every file used in creating the document. Always keep copies of all files sent to the producing plant, as the plant is not responsible for loss or damage to your electronic media.

Acceptable compressed files: Stuffit Expander and WinZip® 7.0. Some problems have occurred opening Stuffit files.

Digital Press Files:

Print quality PDF files needed or vector artwork. If specific Pantone color is needed must use that pantone swatch when being created. If no swatch is specified will be printed in 4 color process.

Colors:

When assigning a color to art or text, please use spot colors, not process colors unless 4-color process.

File Storage:

Zip disks, compact disks (CD) and e-mail files are accepted.

Note:

Following these instructions does not guarantee the electronic art will output.

If sending electronic media is not possible, please send "unscreened", color separated, black and white camera-ready artwork. Camera-ready artwork is not recommended due to the use of computer-to-plate-process.

Cash Receipt
Books
Auto Repair
Forms
Business Checks
Door Hangers
Florist Forms
Envelopes
Invoices
Pest Control Forms
Banking Supplies
Collection Forms
Guest Checks
Sales Books
Checks
HVAC Service Forms
Register Forms
Collection Forms
Deposit Tickets
Janitorial Forms
Laser Statements
DIGITAL PRINTING

1500
HEALTH INSURANCE CLAIM FORM
APPROVED BY NATIONAL UNIFORM CLAIM COMMITTEE DESIGN

STC-305-2
REPAIR TAG
03183
PRINTED IN U.S.A.

YOUR COMPANY NAME
Address
CITY, STATE, ZIP CODE
Phone Number
Advertising Line

CUSTOMER
ADDRESS
MODEL
PROBLEM
SER. NO.
PARTS AND WORK PER

SPECIAL INSTRUCTIONS
REC'D BY
Thank you, CASH ON COMPLETION

FORM SCC-305-2
PRINTED IN U.S.A.

PRINTED WITH SOY INK

WARNING Do not accept this document unless you can see a fine watermark and visible fibers from both sides

YOUR COMPANY NAME
PO. Box
CITY, STATE, ZIP CODE
Telephone Number

First National Bank
Your Town USA
Phone Number

00-00
0000

DATE
DOLLARS \$
CENTS

YOUR COMPANY NAME
AUTHORIZED SIGNATURE

000000 123456789010123456789

YOUR COMPANY NAME
Address
CITY, STATE, ZIP CODE
Phone Number
Advertising Line

INVOICE

SOLD TO
ADDRESS
CITY, STATE, ZIP

SHIP TO
ADDRESS
CITY, STATE, ZIP

CUSTOMER ORDER NO. SALESMAN TERMS F.O.B. DATE

ORDERED	SHIPPED	DESCRIPTION	PRICE	AMOUNT

001001

PURCHASE ORDER

YOUR COMPANY NAME
Address
CITY, STATE, ZIP CODE
Phone Number

Date
To
Address
Please enter our order for the following:

QUANTITY	DESCRIPTION	PRICE	AMOUNT

APPROVED BY

FOR JOB NO. ACCOUNT

001

PURCHASE ORDER

YOUR COMPANY NAME
Address
CITY, STATE, ZIP CODE
Phone Number

Date
To
Address
Please enter our order for the following:

QUANTITY	DESCRIPTION	PRICE	AMOUNT

APPROVED BY

FOR JOB NO. ACCOUNT

001

PURCHASE ORDER